

GENERAL CATALOGUE

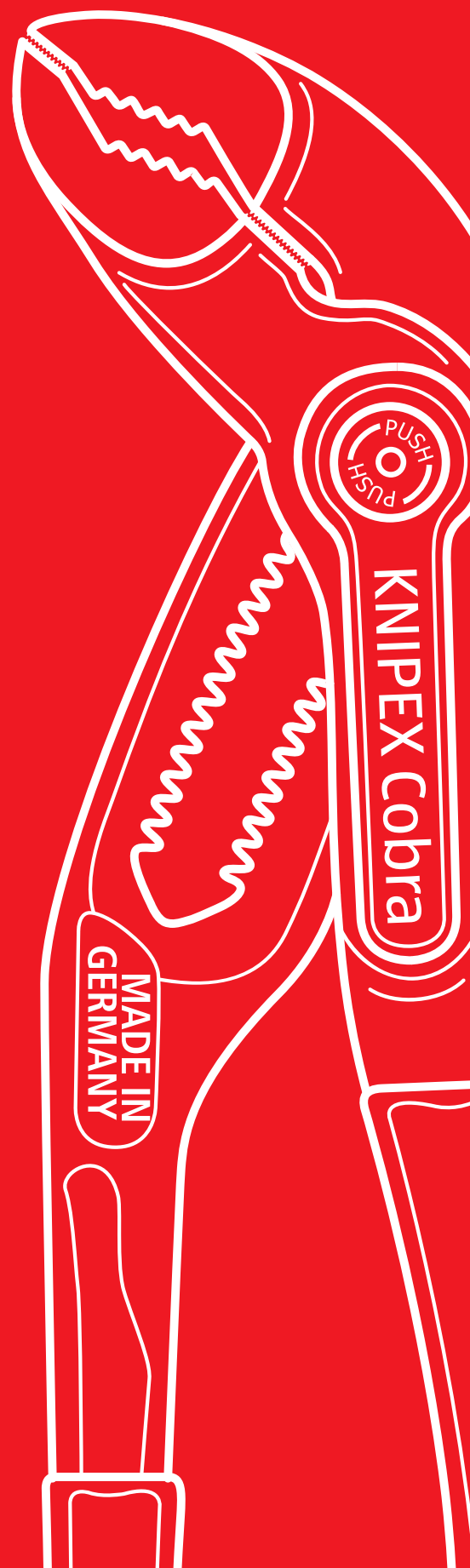

Pliers

MADE IN GERMANY SINCE 1882



The pliers company

KNIPEX Quality – Made in Germany



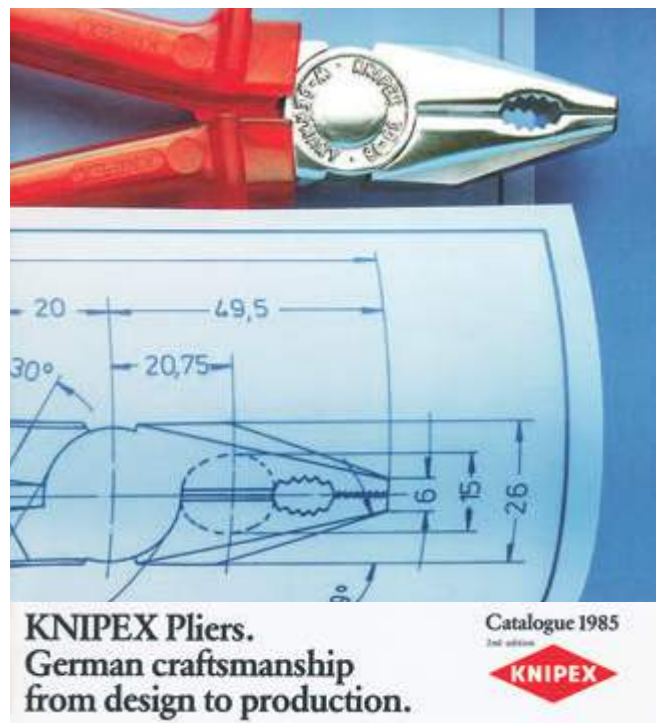
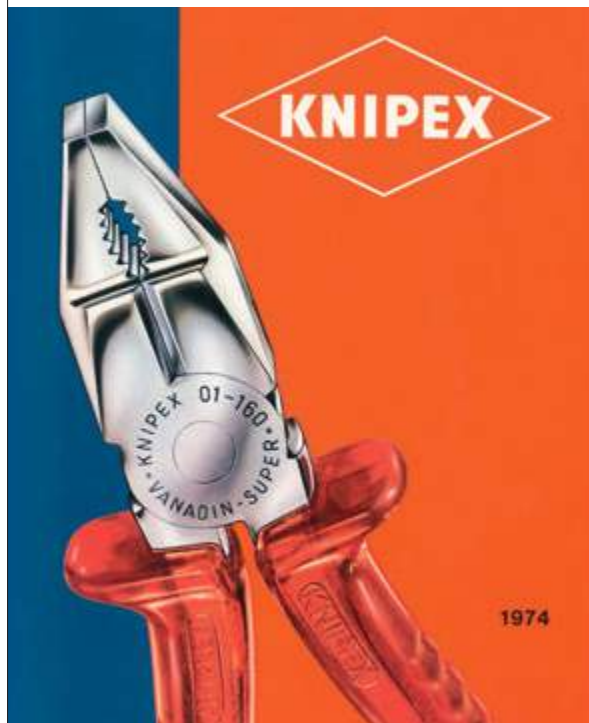
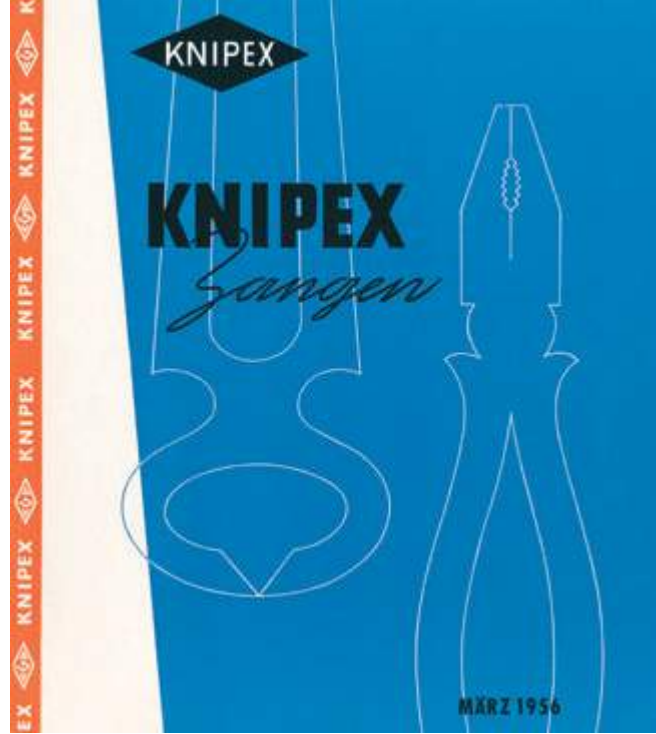

KNIPEX – the company behind the pliers.

For over 130 years and four generations, we have been working passionately on being the best manufacturer of pliers for our customers and users – with a clear focus, high demands and a constant flow of new ideas. Throughout the world, our brand enjoys a great deal of trust, and we aim to consistently meet and rebuild this.

Success is important to us, but is not something we look for at any price. We are guided by values, orientate our actions towards sustainability, and face up to our responsibility towards society and the natural environment in which and with which we live. We invest heavily in the efficiency of our location and the qualification of our employees, working today on the success of tomorrow and the day after that – so that we can also continue to be a strong and reliable partner in the future.

Yours, *Ralf Putsch*



Ralf Putsch, Managing Partner.

1



CoBolt® XL

2



Cobra®

3

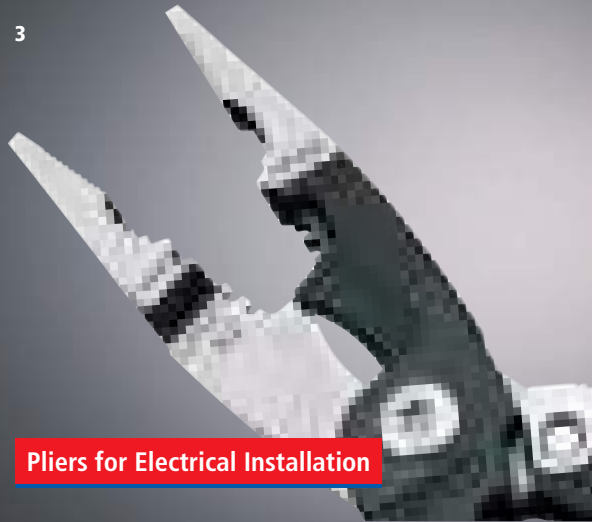

Pliers for Electrical Installation

4

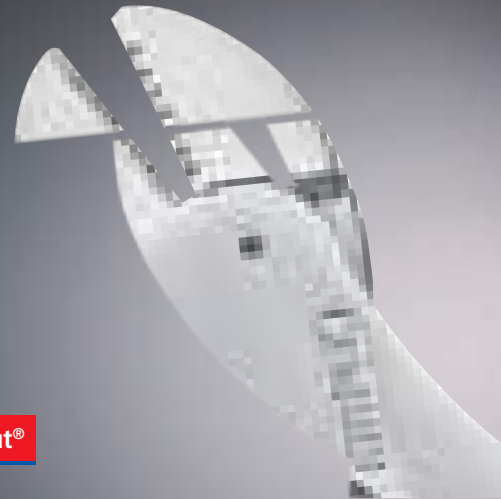

X-Cut®

5

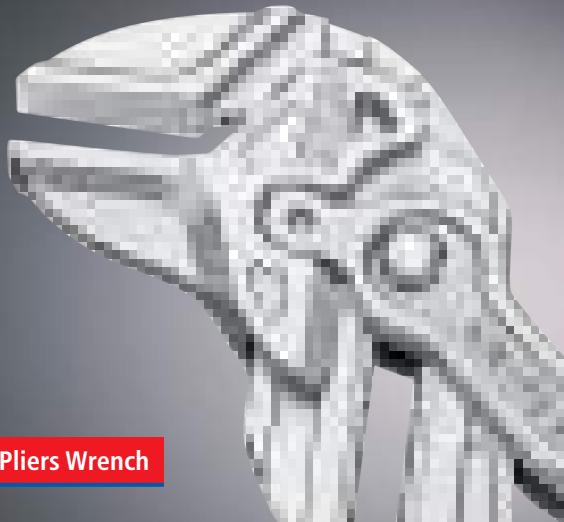

Pliers Wrench

6



TwinForce®

7



Bolt End Cutting Nippers

8



Spring Hose Clamp Pliers

KNIPEX pliers are different: ideas for more use and performance.

Ever better pliers – that is our guiding principle to which we devote all of our expertise and creativity. We are not satisfied with standard solutions, but rather continuously develop new and improved models that are better to work with and easier to use.

Working in this way means that sometimes we find unconventional solutions to situations, which then go on to set new benchmarks in the industry: novel methods of power transmission, easier and faster handling, combining various functions in a single tool and imaginative problem solvers for special applications. These save our users energy and time, giving them better work results with less effort.

In addition to major innovations, we work continuously on reworking our models in lots of small steps to improve their function, ergonomics and service life.

- 1 **Compact force:** CoBolt® XL – two-hand operation for maximum cutting force.
- 2 **Easy operation:** Cobra® – fast grip, precise adjustment, hold with self-locking.
- 3 **Multifunctional:** electrical installation pliers – six functions in one pair of pliers.
- 4 **Universal cutting force:** X-Cut® – the first high leverage diagonal cutters with box joint and precision cutting edges.
- 5 **Speed and versatility:** pliers wrench – screws, holds, bends and presses without damaging materials.
- 6 **High performance cutting edges:** TwinForce® – high strength thanks to unique transmission.
- 7 **End cutting nippers – redefined:** bolt end cutting nippers – light, slim, cut directly on the pivot point.
- 8 **Problem-solver:** spring hose clamp pliers – the only pliers for all clamps; apply safely from all angles.

Step by step: from idea to product.

A large number of steps lie between an initial idea and the finished product. We never lose sight of the fact that every new or further development must represent a noticeable improvement for the user. We deploy the most up to date technologies and processes when putting our ideas into practice.

We begin by carefully establishing the requirements and selecting the best concepts. The tool is constructed on a computer, and the function is simulated with the help of special software. This is followed by the first models made on a 3D printer and by milling and extensive tests on steel prototypes – naturally in close dialogue with experienced users. The first products manufactured using series production processes are subjected to further extensive tests – under conditions far more stringent than normal load.

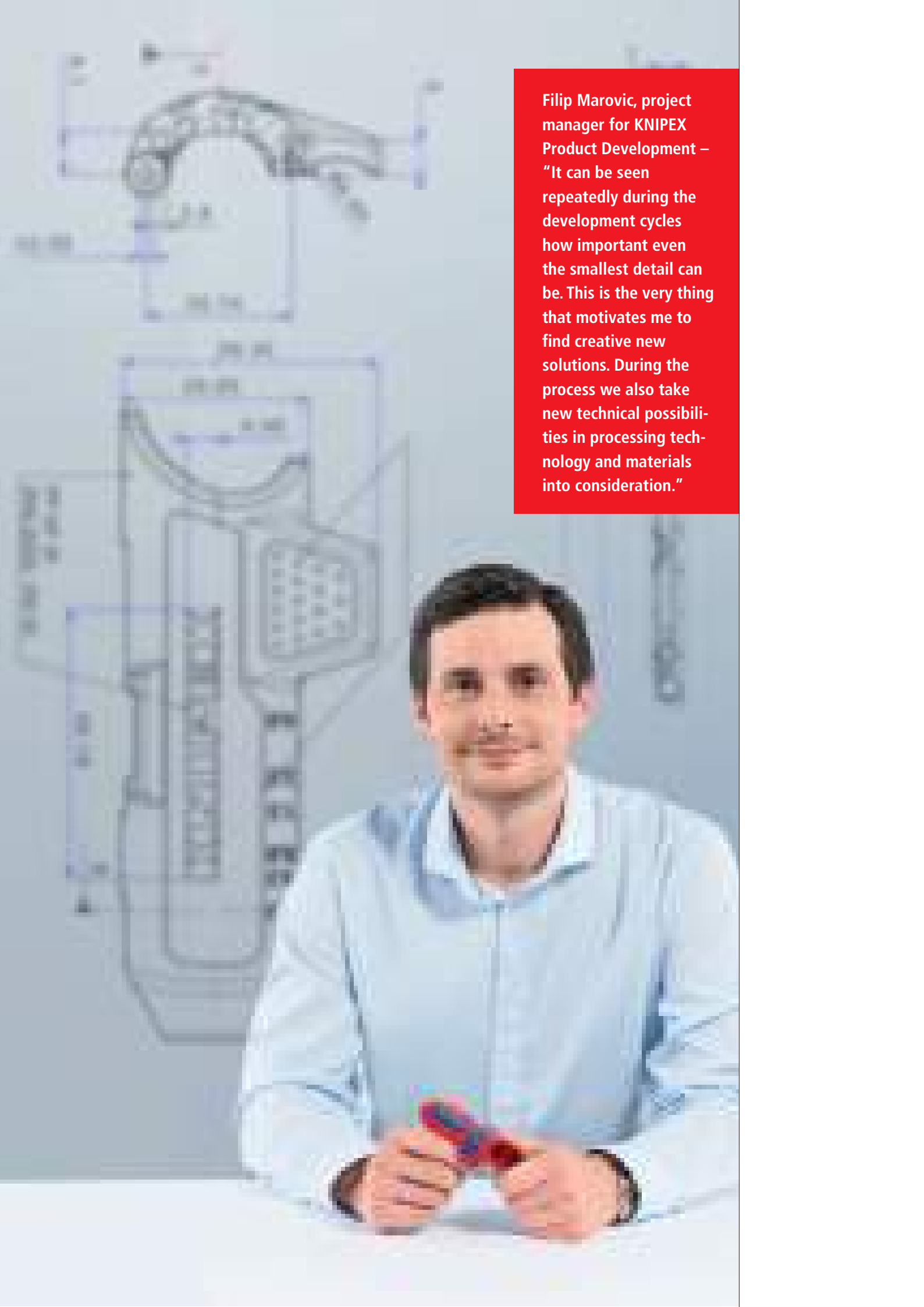

The locking mechanism on the spring hose clamp pliers permit simple and safe work, even with closed clamps. Modern CAD technology simulates the mechanism on the screen.

A man with dark hair, wearing a light blue button-down shirt, is sitting at a white desk. He is looking directly at the camera with a slight smile. His hands are resting on the desk, holding a red and blue object. Behind him, a wall is covered with various technical drawings and diagrams in blue ink, including a large curved component at the top and a more complex assembly below it. The lighting is bright and even.

Filip Marovic, project manager for KNIPEX Product Development – “It can be seen repeatedly during the development cycles how important even the smallest detail can be. This is the very thing that motivates me to find creative new solutions. During the process we also take new technical possibilities in processing technology and materials into consideration.”

Core qualities: steel – and what we make from it.

You can expect a great deal more from a pair of KNIPEX pliers. This starts with the material. Because the many models of pliers in our range are designed for different requirements and loads, we use steel alloys that have been specially selected for the application and rolled according to our high specifications. Long lasting cutting capability when working with very hard wires, strength when working with high torque loads, and good resistance to corrosion are examples of these targets.

The respective materials are then given their specific molecular structure in a number of coordinated heat treatment steps to produce the optimal relationship between hardness and toughness. These processes allow us to achieve the high degree of reliability, durability and service life that are the very definition of KNIPEX pliers.

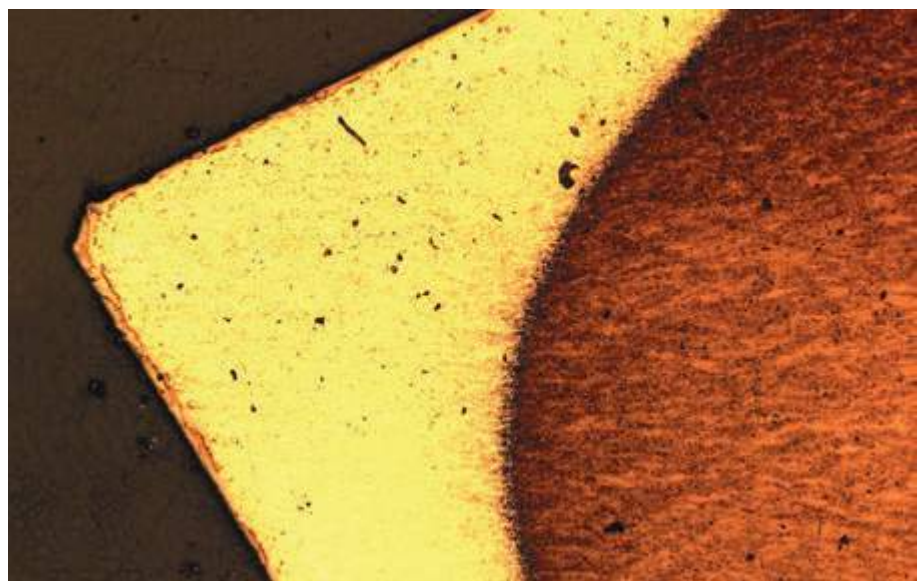

Macro image of a cutter after induction hardening. The specially hardened cutter area (light) is in sharp contrast to the softer structure of the body of the pliers (dark).



Handles of the "Alligator®
water pump pliers" being
forged under the hydraulic
double-acting hammer.



This is how our pliers are given their shape: hot and under high pressure.

Forging as a forming process is an old cultural technique and continues to hold fascination today. With an impact of up to five tonnes, the yellow glowing piece of steel is pounded in the upper and lower die at a temperature of 1,250°C. This gives it its basic shape and simultaneously a well-compacted structure.

The production of the forging die in our toolmaking works requires a great deal of experience and high precision, as this raw component will be crucial to the subsequent quality of the pliers. The contours of the forged component are milled at processing centres in the hardened and high strength die block.



Forging die for the high leverage diagonal cutters with forged-in axle.

The technology behind the pliers: machines made by KNIPEX.

All tools can only be as good as the production technology used to manufacture them. In other words, there can be no superior products without advances in production processes.

Due to our specialisation, we can focus on the technologies needed to produce high quality pliers efficiently. We have more than 400 machines, built with the specialised knowledge of generations. We build many of the machines ourselves or adapt machines precisely to our high standards using components we have manufactured. We even programme the software for the control and operation of the machinery ourselves in many cases.

From the product idea to the despatch of the finished pliers to our customers: everything is done under one roof. In this way we can directly influence all steps of value creation ourselves in terms of quality and efficiency, and make continuous improvements. Short paths and direct dialogue simplify coordination of processes and communication between employees.

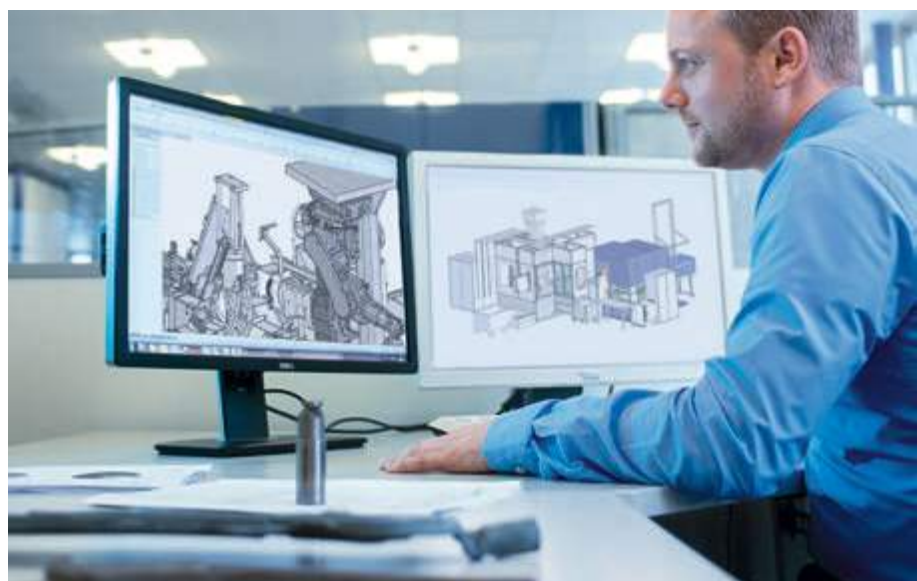

We ensure our high standards by developing our own processes and machinery.

A wide-angle photograph of a modern industrial factory floor. In the foreground, a worker in a dark blue uniform is operating a large orange robotic arm. The background is filled with complex machinery, conveyor belts, and structural beams, creating a sense of a busy, automated production environment. The lighting is bright and even, highlighting the metallic surfaces and the organized layout of the factory.

Efficiently coordinated
processes and machinery.

Over 45,000 pairs
of different models of
pliers leave our factory
every day.

Only after several test cuts, does a pair of KNIPEX cutting pliers leave our factory.

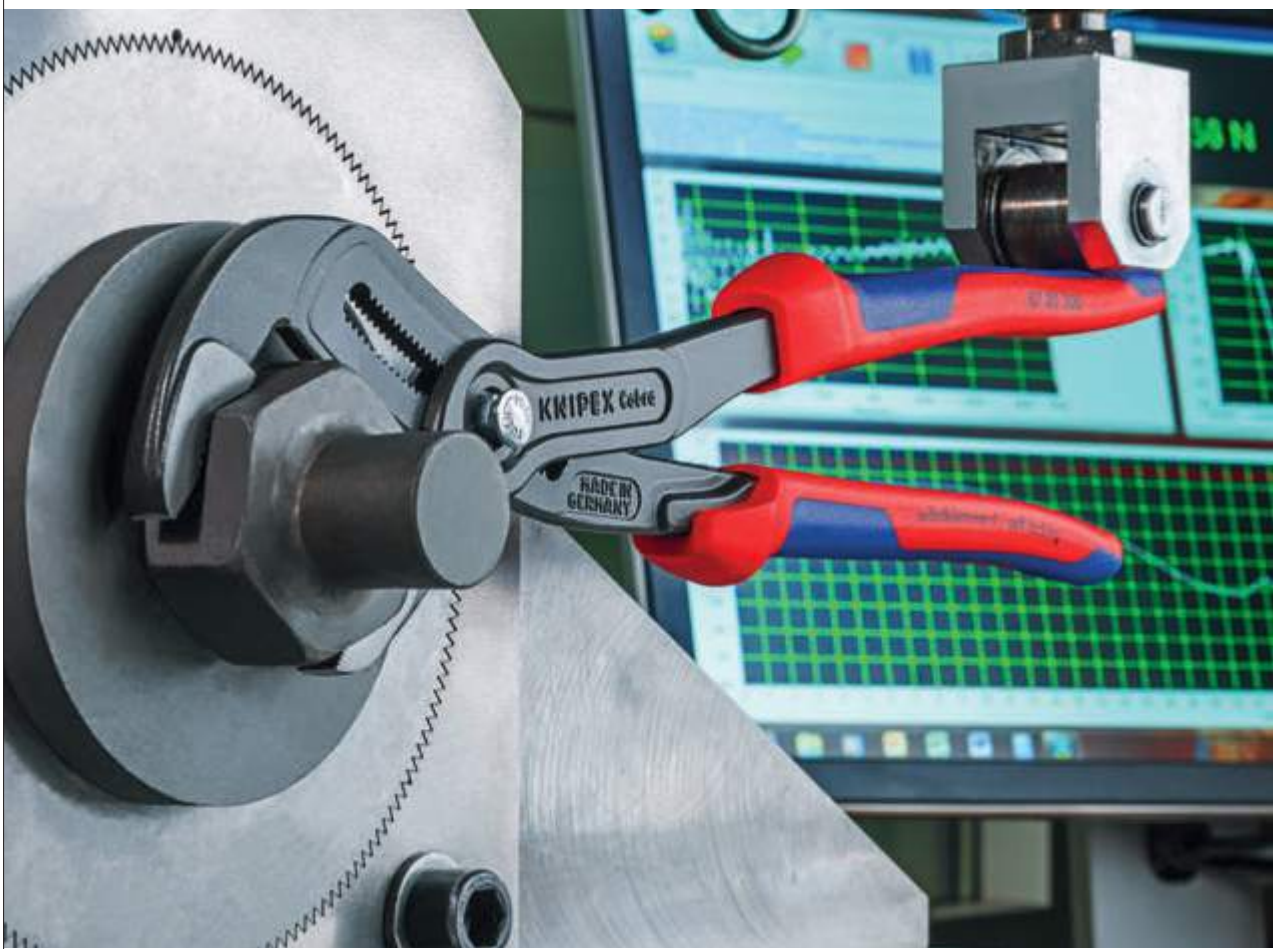

We take it very literally: 100% reliability.

The precision of pliers is essential for their function: without accuracy there can be no reliable cutting, gripping and shaping, and also no zero backlash. The tight tolerances, which we make sure are complied with through the use of modern production technology, enable us to meet our stringent quality specifications.

We ensure compliance through strict measurements and diverse inspections – both after the various production steps and at the end of the entire process. To do this we use the most up-to-date measurement technology and endurance test plants – as well as the practical component test by hand.



Shape and roughness of the diagonal cutter's cutting edge are precisely measured with an optical 3D measuring system.

More than excellent pliers: what else you can expect from us.

Quality does not stop with the product. Trust, reliability and a collaborative approach define our business relationships – with consistent customer orientation, good service and competent field staff. We provide advice and training, and supply you with extensive digital product data whose format we adapt to your specific requirements. Added to this are diverse possibilities for sales support.

You will not find the breadth and depth of our range with any other manufacturer worldwide – so that your customers can always find the tool they are looking for.



We also present the breadth and depth of our range at in-house exhibitions and open days.





At home in the world: locations in more than 100 countries for you.

KNIPEX is the global pliers brand. We are present in all continents, with a dense network of customers, representatives and branches. In order to be closer still to our retailers and be able to give them even better support, we are further extending our international activities all the time.

There is no substitute for direct contact, which is why we are there for you personally at more than 100 trade fairs each year. On platforms and with the help of the most varied media – classic and digital – we provide comprehensive information about our range and application opportunities in over 30 languages. We reach users and fans throughout the whole world via social media and hundreds of KNIPEX online videos.



We make up to date information available digitally in several languages on all usual channels.

The key factor: our employees.

The most important basis of our success is our employees. Their knowledge and skills, their dedication and their ideas are crucial to our efficiency and thus to our future.

As a company, we are a social community. We want to shape our culture in such a way that allows our employees to participate and identify through their work but also as individuals. We create good conditions for our employees to develop their potential, to obtain further qualifications and to stay healthy. It is also important to us that our employees are able to successfully balance family and career

We invest a significant amount of both expense and care in the training of young people, but also impart a wide spectrum of professional and personal skills to other employees.



Our junior staff obtain their qualifications in our own modern training workshop.





Acting responsibly – sustainable management.



As a company, we believe we share responsibility for our natural environment and the well-being of society. We interact with both in various ways. We consume resources, but take care to use them as carefully as possible, and want to make a contribution to ensuring that they are available to future generations in the same or where possible a better form.

Our ecological objectives include a continuous reduction in our energy consumption, reduction in the volumes of waste and caring for the biodiversity at our site. In addition, we participate in major climate protection projects.

Companies should also be good citizens. We support numerous institutions and organisations from the areas of education and culture. We maintain a close exchange with schools and universities, and strengthen civic engagement in our region in diverse ways.



We support the Bergische music school in the “Singpause” project which, with the help of specially trained teachers, communicates the foundations of music and pleasure at singing together in schools.

At a glance

Overview of products

2	Combination and Multifunctional Pliers Combination Pliers Pliers for Installation Round Nose and Flat Nose Pliers	
16	Wire Strippers and Dismantling Tools Insulation Strippers with adapted blades MultiStrip 10 Dismantling Tools	
42	Gripping and Grip Pliers Flat Nose Pliers Round Nose Pliers Grip Pliers	
54	Circlip Pliers Circlip Pliers Precision Circlip Pliers Circlip Pliers Sets	
70	Carpenters' Pincers and Concreters' Nippers Carpenters' Pincers Concreter's Nippers High Leverage Concreters' Nippers	
76	Cutting Pliers Diagonal Cutters Bolt Cutters End Cutting Nippers	
100	Pipe Wrenches and Water Pump Pliers Pliers Wrenches KNIPEX Cobra® KNIPEX Alligator® Pipe Wrenches	
122	Pipe Cutter KNIPEX PlastiCut® KNIPEX TwistCut® KNIPEX TubiX®	
134	Special Pliers and Control Cabinet Keys Pipe Cutters Spring Hose Clamp Pliers Magnetic LED Lamp Control Cabinet Keys	
150	Cable and Wire Rope Shears Cable Shears Cable Cutters with ratchet action Wire Rope Shears	
166	Crimping Pliers and Crimp Assortments Crimp System Pliers KNIPEX PreciForce® Cable Connectors	
198	Insulated Tools Pliers Wrenches Screwdrivers Sets	
242	Electronics Pliers and Precision Tweezers Cutting Pliers Gripping Pliers Precision Tweezers	
272	Pliers with tether attachment point for mounting a fall protection	
278	Tool Assortments and Tool Cases Pliers Sets Tool Bags Tool Cases	
338	Index / Article Number Index Pliers-ABC	

Combination and Multifunctional Pliers



Combination Pliers	4
High Leverage Combination Pliers	5
Needle-Nose Combination Pliers	6
Mini Combination Pliers	7
Lineman's Pliers American style	8
WireStripper – Multifunction Electrician Pliers, American style	9
Pliers for Electrical Installation	10
Electricians' Pliers	12
Round Nose Pliers with cutting edge (Jewellers' Pliers)	12
Snipe Nose Side Cutting Pliers (Radio Pliers)	13
Snipe Nose Side Cutting Pliers (Stork Beak Pliers)	14

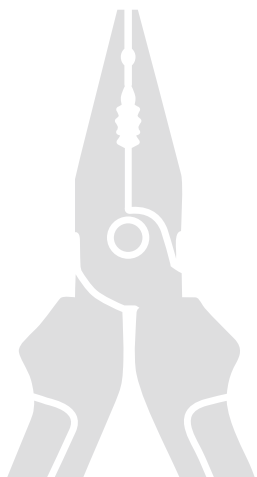

Combination Pliers

- > With gripping zones for flat and round material, suitable for versatile use
- > With cutting edges for soft and hard wire
- > Long cutting edges for thicker cables
- > Cutting edges additionally induction-hardened, cutting edge hardness approx. 60 HRC
- > Special tool steel, forged, multi stage oil-hardened
- > DIN ISO 5746

03 06 180 T*

> Pliers with tether attachment point for mounting a fall protection



03 01 180

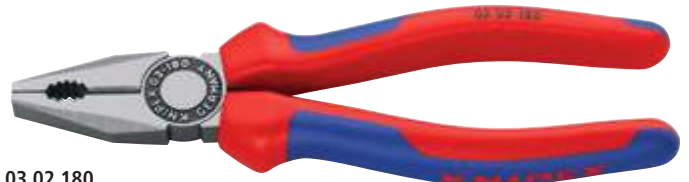

03 02 180



03 05 180



03 06 180 T



03 07 200

Article No.	EAN 4003773-	↔ mm	Pliers	Head	Handles	Cutting capacities				
						Ø mm	Ø mm	Ø mm	mm ²	Δ g
03 01 140	015192	140	black atramentized	polished	plastic coated	2.8	1.8	9.0	10	106
03 01 160	013235	160				3.1	2.0	10.0	16	187
03 01 180	013242	180				3.4	2.2	12.0	16	216
03 01 200	013259	200				3.8	2.5	13.0	16	276
03 01 250	015222	250				3.8	2.5	15.0	25	480
03 02 160	023203	160	black atramentized	polished	with multi-component grips	3.1	2.0	10.0	16	223
03 02 180	023197	180				3.4	2.2	12.0	16	254
03 02 200	034940	200				3.8	2.5	13.0	16	322
03 05 140	039730	140	chrome plated	chrome plated	with multi-component grips	2.8	1.8	9.0	10	139
03 05 160	039518	160				3.1	2.0	10.0,0	16	222
03 05 180	034933	180				3.4	2.2	12.0	16	254
03 05 200	041146	200				3.8	2.5	13.0	16	324
03 06 160	021902	160	chrome plated	chrome plated	insulated with multi-component grips, VDE-tested	3.1	2.0	10.0	16	228
03 06 180	021926	180				3.4	2.2	12.0	16	264
03 06 200	033776	200				3.8	2.5	13.0	16	355
03 06 180 T	081395	180	chrome plated	chrome plated	insulated with multi-component grips, VDE-tested, with integrated insulated tether attachment point for a tool tether	3.4	2.2	12.0,0	16	270
03 07 160	015307	160	chrome plated	chrome plated	with dipped insulation, VDE-tested	3.1	2.0	10.0	16	254
03 07 180	015314	180				3.4	2.2	12.0	16	285
03 07 200	015321	200				3.8	2.5	13.0	16	339
03 07 250	015345	250				3.8	2.5	15.0	25	597

High Leverage Combination Pliers

- ▶ 35 % less effort required than with conventional combination pliers
- ▶ With cutting edges (hardness approx. 63 HRC) for heavy duty

- > Easier work due to optimised leverage
- > Easier cutting, powerful gripping, bending and pulling
- > Long cutting edges for thicker cables
- > With gripping zones for flat and round material, suitable for versatile use
- > High-grade special tool steel, forged, multi stage oil-hardened
- > Cutting edges additionally induction-hardened, cutting edge hardness approx. 63 HRC
- > DIN ISO 5746

02 02 225 T*

- > Pliers with tether attachment point for mounting a fall protection



02 01 200



02 02 180



02 02 225 T



02 05 180



02 06 180



02 07 225

Article No.	EAN 4003773-	↔ mm		Pliers	Head	Handles	Cutting capacities				⚖ g
							● Ø mm	● Ø mm	⊕ Ø mm	⊕ mm²	
02 01 180	033134	180		black atramentized	polished	plastic coated	2.5	2.0	11.5	16	202
02 01 200	039679	200		black atramentized	polished	plastic coated	2.8	2.2	13.0	25	298
02 01 225	013198	225		black atramentized	polished	plastic coated	3.0	2.5	14.0	25	355
02 02 180	034896	180		black atramentized	polished	with multi-component grips	2.5	2.0	11.5	16	240
02 02 200	034902	200		black atramentized	polished	with multi-component grips	2.8	2.2	13.0	25	342
02 02 225	043379	225		black atramentized	polished	with multi-component grips	3.0	2.5	14.0	25	405
02 02 225 T	079934	225		black atramentized	polished	with multi-component grips and integrated tether attachment point	3.0	2.5	14.0	25	410
02 05 180	043072	180		chrome plated	chrome plated	with multi-component grips	2.5	2.0	11.5	16	238
02 05 200	043089	200		chrome plated	chrome plated	with multi-component grips	2.8	2.2	13.0	25	342
02 05 225	010005	225		chrome plated	chrome plated	with multi-component grips	3.0	2.5	14.0	25	400
02 06 180	010012	180		chrome plated	chrome plated	insulated with multi-component grips, VDE-tested	2.5	2.0	11.5	16	247
02 06 200	010029	200		chrome plated	chrome plated	insulated with multi-component grips, VDE-tested	2.8	2.2	13.0	25	343
02 06 225	010036	225		chrome plated	chrome plated	insulated with multi-component grips, VDE-tested	3.0	2.5	14.0	25	401
02 07 200	022299	200		chrome plated	chrome plated	with dipped insulation, VDE-tested	2.8	2.2	13.0	25	380
02 07 225	022305	225		chrome plated	chrome plated	with dipped insulation, VDE-tested	3.0	2.5	14.0	25	486

Needle-Nose Combination Pliers

Small High Leverage Combination Pliers with pointed jaw. For all common installation and repair work.

- ▶ Handy use when working in confined areas thanks to slim head design and pointed jaws (anti-twist)
- ▶ Gripping surfaces with special convex contour on one side for secure gripping of flat parts
- ▶ Milled groove in the gripping area permits small parts such as nails, pins and bolts to be held and pulled

- > The reliable and diverse combination pliers when out and about
- > Easy cutting thanks to the high leverage joint
- > With cutting edges for soft, medium-hard and hard wire
- > Long service life and stable tips
- > Forged from special high grade tool steel, manifold oil-hardened
- > Cutting edges additionally induction-hardened, cutting edge hardness approx. 59 – 63 HRC
- > DIN ISO 5746

08 22 145 T / 08 26 145 T*

> Pliers with tether attachment point for mounting a fall protection

PATENTED



08 21 145



08 22 145



08 22 145 T



08 25 145



08 26 145



08 26 145 T

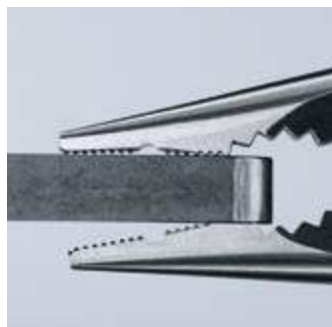

Firm grip also on flat material due to three-point rest























Milled groove in the gripping area



Tip keeps its shape even during greater torsional forces



Slim head for ideal accessibility

Article No.	EAN 4003773-	↔ mm	 	Pliers	Head	Handles	Cutting capacities				
							 Ø mm	 Ø mm	 Ø mm	 mm ²	 g
08 21 145	078951	145	 	black atramentized	polished	plastic coated	3.0	2.0	8.0	16	116
08 22 145	078968	145	 	black atramentized	polished	with multi-component grips	3.0	2.0	8.0	16	145
08 22 145 T	080640	145	 	black atramentized	polished	with multi-component grips and integrated tether attachment point	3.0	2.0	8.0	16	150
08 25 145	078975	145	 	chrome plated	chrome plated	with multi-component grips	3.0	2.0	8.0	16	145
08 26 145	079361	145	  	chrome plated	chrome plated	insulated with multi-component grips, VDE-tested	3.0	2.0	8.0	16	145
08 26 145 T	081401	145	  	chrome plated	chrome plated	insulated with multi-component grips, VDE-tested, with integrated insulated tether attachment point for a tool tether	3.0	2.0	8.0	16	155

Combination Pliers

Chrome Vanadium

- > For heavy duty
- > With gripping zones for flat and round material, suitable for versatile use
- > With cutting edges for soft, hard and piano wire
- > Long cutting edges for thicker cables
- > Cutting edges additionally induction-hardened, cutting edge hardness approx. 64 HRC
- > Particularly wear resistant gripping jaws; hardness of the gripping jaws approx. 53 HRC
- > Chrome vanadium heavy-duty steel, forged, multi stage oil-hardened
- > DIN ISO 5746, DIN EN 60900, IEC 60900



01 06 160

Article No.	EAN 4003773-	↔ mm		Pliers	Head	Handles	Cutting capacities				Δ g
							Ø mm	Ø mm	Ø mm	mm ²	
01 06 160	040729	160		chrome plated	chrome plated	insulated with multi-component grips, VDE-tested	2.0	1.5	10.0	16	220
01 06 190	040415	190					2.5	2.0	13.0	25	320

Mini Combination Pliers

- > Compact combination pliers for professionals and hobbyists
- > With gripping zones for flat and round material, suitable for versatile use
- > With cutting edges for soft and hard wire
- > Cutting edges additionally induction-hardened, cutting edge hardness approx. 60 HRC
- > Vanadium electric steel, forged, multi stage oil-hardened



08 05 110

Article No.	EAN 4003773-	↔ mm		Pliers	Head	Handles	Cutting capacities				Δ g
							Ø mm	Ø mm	Ø mm	mm ²	
08 05 110	034957	110		chrome plated	chrome plated	with multi-component grips	2.5	1.6	9.0	10	85

Lineman's Pliers

American style

- ▶ High transmission ratio for easy cutting
- ▶ Requires 50 % less effort compared with conventional combination pliers thanks to optimised transmission ratio
- > Solid construction for heaviest strain; universally applicable
- > Ergonomically optimised handle shape for firm contact to the hand and fatigue reducing operation
- > Particularly effective cross-hatched knurled gripping zone in the jaws – for strong gripping and pulling
- > Additional gripping zone below the joint for powerful leverage and pressing performance
- > With cutting edges for soft and hard wire
- > Cutting edges additionally induction-hardened, cutting edge hardness approx. 64 HRC
- > Vanadium electric steel, forged, multi stage oil-hardened
- > DIN ISO 5746, ASME B107.20

09 02 240 T / 09 12 240 T*

- > Pliers with tether attachment point for mounting a fall protection

09 11 240 / 09 12 240 / 09 12 240 T*

- > With fish tape puller in the joint gap; with universal mandrel crimping point below the joint



09 01 240

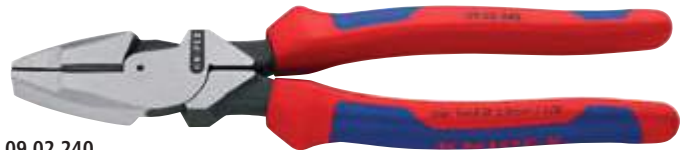

09 02 240



09 02 240 T



09 11 240



09 12 240



09 12 240 T



09 11/12 240: fish tape puller in the joint gap

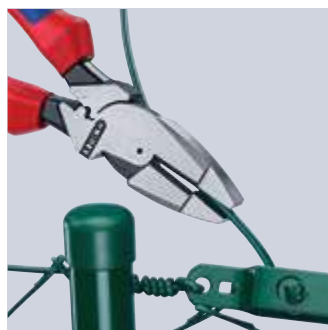

















Cross-hatched, knurled gripping zone for firm gripping and pulling, e. g. for fence construction



Long cutting edges for cutting flat cables



09 11/12 240: universal mandrel crimping area below the joint

Article No.	EAN 4003773-	↔ mm	 	Pliers	Head	Handles	Cutting capacities		
							 Ø mm	 Ø mm	 g
09 01 240	064992	240	 	black atramentized	polished	with non-slip plastic coating	4.6	3.0	435
09 02 240	065005	240	 	black atramentized	polished	with multi-component grips	4.6	3.0	470
09 02 240 T	079941	240	 	black atramentized	polished	with multi-component grips and integrated tether attachment point	4.6	3.0	463
09 11 240	071952	240	 	black atramentized	polished	with non-slip plastic coating	4.6	3.0	435
09 12 240	071969	240	 	black atramentized	polished	with multi-component grips	4.6	3.0	470
09 12 240 T	079958	240	 	black atramentized	polished	with slim multi-component grips, with integrated tether attachment point for a tool tether	4.6	3.0	455

WireStripper

Multifunction Electrician Pliers, American style

Superior 7-in-1 multifunctional tool for electrical installation

- ▶ Strip faster: Precise positioning of the wire thanks to location ridges
 - ▶ Innovative cutting edge geometry, particularly powerful cutting edges: 50% higher cutting capacity and 25% less cutting effort compared to standard wire strippers
 - ▶ Fast, burr-free cutting of threaded rods and screws of UNC 6 – 32 and 8 – 32 up to class 4.6
- > Precisely ground: Stripping profiles for conductors from 18 – 10 AWG (solid) and 20 – 12 AWG (finely stranded)
 - > Easy cutting of copper and aluminium cables up to Ø 15 mm (1/2")
 - > Multifunctional gripping surfaces for reliable gripping, holding and bending of flat and round material as well as for twisting wires
 - > High stability and good accessibility thanks to hybrid tips on the pliers head, which are flat and wide
 - > Convenient: Comfortable opening width and ergonomic handle shape, integrated opening spring makes frequent cutting easier
 - > Ideal for right- and left-handed users: locking device can be operated from either side
 - > Clear-cut outside edges on the jaws for working on flush-mounted junction boxes and deburring feed-through holes
 - > High-grade special tool steel, forged, multi stage oil-hardened



13 71 8



13 72 8



Laser marking of the stripping profiles for AWG dimensions shows stripping capacities for solid and stranded conductors



No screw is necessary: saves time cutting threaded rods and screws of sizes UNC 6 – 32 and 8 – 32 up to class 4.6

Designed for AWG cable cross-sections and UNC threads common in the USA, Great Britain, Australia – not suitable for metric cables and materials



More convenience: cuts cables up to Ø 15 mm (1/2") up to 25% easier than comparably sized cable cutters, thanks to the stepped cutting edges



The precision-manufactured locating ridges allow for a quick selection of the correct stripping hole



The integrated opening spring makes frequent cutting easier – and it can be secured with a lock for transport

Article No.	EAN	↔		Pliers	Head	Handles	⊕	⊕	AWG	⚖
	4003773-	mm					Ø Inch	mm		g
13 71 8	086673	200	MM	black atramentized	polished	plastic coated	1/2	15	20 - 10	260
13 72 8	086680	200	MM	black atramentized	polished	with multi-component grips	1/2	15	20 - 10	275

Pliers for Electrical Installation

PATENTED

The all-rounder for professionals

- ▶ 6 functions in one pair of pliers
- ▶ Multifunctional pliers for the electrical installation; to grip flat and round material, for bending, deburring, cutting cable, stripping and crimping wire ferrules

- > Smooth surfaces near the tips grip single cores without damaging them; serrated gripping surfaces and pipe grip for gripping flat and round material
- > Clear-cut outside edge on the gripping surfaces for working on flush-mounted junction boxes and deburring feed-through holes
- > Stripping holes for conductors of 0.75 – 1.5 mm² and 2.5 mm²
- > Crimping die for wire ferrules 0.5 – 2.5 mm²
- > Cable shears with (induction-hardened) precision cutting edges for copper and aluminium cables up to 5 x 2.5 mm² / dia. 15 mm
- > Slim dimensions for easy access
- > Bolted joint: precise, zero backlash operation of pliers
- > High-grade special tool steel, forged, multi stage oil-hardened

13 82 200 T / 13 96 200 T*

- > Pliers with tether attachment point for mounting a fall protection

13 91 200 / 13 92 200 / 13 96 200

- > In case of models with opening spring integrated in the joint, the activated locking lever keeps the cutting edges closed while other functions remain active; the intelligent latching mechanism enables you to "grip" without opening the pliers. The cutting edge remains closed and protected.



13 81 200



13 82 200



13 82 200 T



13 86 200



13 91 200



13 92 200



13 96 200





13 96 200 T





- Smooth gripping surface**
for a non-damaging gripping and flattening, round-shaping (form wire loops)
- Profiled gripping surface**
to protect the workpiece, flattened for stronger yet gentle gripping
- Clear-cut outside edge**
for deburring and widening holes
- Pipe grip**
for round parts and cables
- Universal crimp die**
for end sleeves (ferrules) from 0.5 to 2.5 mm²
- Stripping**
for copper conductors from 0.75 to 1.5 and 2.5 mm²
- Shear blade**
for cutting copper cable up to Ø 15 mm (5 x 2.5 mm²)

13 91 200 / 13 92 200 / 13 96 200
in case of models with opening spring integrated in the joint, the activated locking lever keeps the cutting edges closed while other functions remain active; the intelligent latching mechanism enables you to “grip” without opening the pliers. The cutting edge remains closed and protected.

Article No.	EAN 4003773-	↔ mm	Pliers	Head	Handles	Cutting capacities		Stripping capacity for cross-sections mm ²	Crimping capacities mm ²	⚖ g
						Ø mm	mm ²			
13 81 200	075240	200	black atramentized	polished	plastic coated	15.0	50	0.75 – 1.5 / 2.5	0.5 – 2.5	265
13 82 200	075080	200	black atramentized	polished	with multi-component grips	15.0	50	0.75 – 1.5 / 2.5	0.5 – 2.5	280
13 82 200 T	079972	200	black atramentized	polished	with multi-component grips and integrated tether attachment point	15.0	50	0.75 – 1.5 / 2.5	0.5 – 2.5	267
13 86 200	075097	200	 1000V chrome plated	chrome plated	insulated with multi-component grips, VDE-tested	15.0	50	0.75 – 1.5 / 2.5	0.5 – 2.5	280
13 91 200	075257	200	black atramentized	polished	plastic coated	15.0	50	0.75 – 1.5 / 2.5	0.5 – 2.5	265
13 92 200	075103	200	black atramentized	polished	with multi-component grips	15.0	50	0.75 – 1.5 / 2.5	0.5 – 2.5	280
13 96 200	075110	200	 1000V chrome plated	chrome plated	insulated with multi-component grips, VDE-tested	15.0	50	0.75 – 1.5 / 2.5	0.5 – 2.5	280
13 96 200 T	081425	200	 1000V chrome plated	chrome plated	insulated with multi-component grips, VDE-tested, with integrated insulated tether attachment point for a tool tether	15.0	50	0.75 – 1.5 / 2.5	0.5 – 2.5	275

Electricians' Pliers

- > The ideal pliers for cable work
- > For gripping and bending wire
- > For cutting medium hard and hard wire
- > Precision cutting edges additionally induction-hardened, cutting edge hardness approx. 60 HRC
- > With precision stripping holes
- > For crimping wire ferrules
- > Vanadium electric steel, forged, multi stage oil-hardened

13 05 160 T*

- > Pliers with tether attachment point for mounting a fall protection

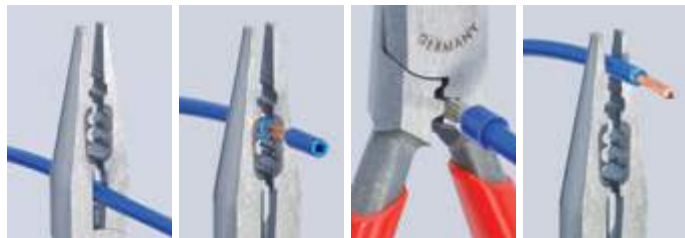

Cutting Edges Stripping Crimping 0.5 to 2.5 mm² Gripping



Article No.	EAN 4003773-	↔ mm	Pliers	Head	Handles	Cutting capacities		Stripping capacities mm ²	Δ g	
						● mm	● mm			
13 01 160	034971	160		black atramentized	polished	plastic coated	2.5	1.6	0,5 – 0,75 / 1,5 / 2,5	112
13 02 160	010470	160		black atramentized	polished	with multi-component grips	2.5	1.6	0,5 – 0,75 / 1,5 / 2,5	139
13 05 160	071426	160		chrome plated	chrome plated	with multi-component grips	2.5	1.6	0,5 – 0,75 / 1,5 / 2,5	139
13 05 160 T	079965	160		chrome plated	chrome plated	with multi-component grips and integrated tether attachment point	2.5	1.6	0,5 – 0,75 / 1,5 / 2,5	142

Round Pliers with cutting edge

Jewellers' Pliers

- > For gripping and manipulating fine wires, e.g. in jewellery work
- > Ideal for cutting and bending activities, also in electronics
- > For bending wire loops
- > Precision-ground round jaws with fine, pointed tips
- > Cutting edges additionally induction-hardened, cutting edge hardness approx. 60 HRC
- > Vanadium electric steel, forged, multi stage oil-hardened



19 01 130

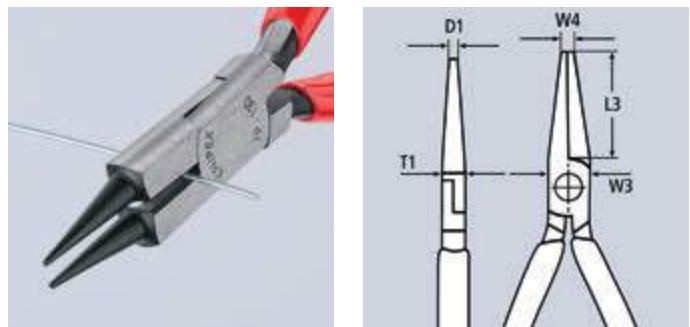

Article No.	EAN 4003773-	↔ mm	Pliers	Head	Handles	Cutting capacities		Dimensions					Δ g	
						● mm	● mm	D1 mm	L3 mm	T1 mm	W3 mm	W4 mm		
19 01 130	034995	130		black atramentized	polished	plastic coated	2.2	1.6	1.0	32.0	8.0	13.5	2.0	73
19 03 130	014348	130		chrome plated	chrome plated	plastic coated	2.2	1.6	1.0	32.0	8.0	13.5	2.0	72

Snipe Nose Side Cutting Pliers

Radio Pliers

- > Suitable for finer gripping and cutting work
- > Half-round, long, tapered jaws
- > Knurled gripping surfaces
- > With cutting edges for soft, medium-hard and hard wire
- > Cutting edges additionally induction-hardened, cutting edge hardness approx. 61 HRC
- > Vanadium electric steel, forged, multi stage oil-hardened
- > DIN ISO 5745

25 06 160 T*

- > Pliers with tether attachment point for mounting a fall protection

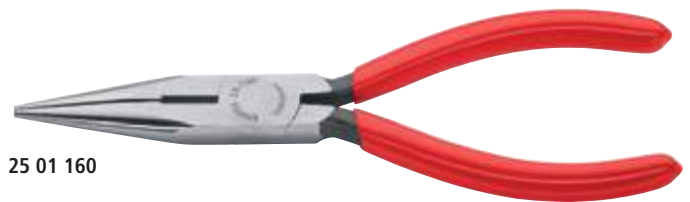

25 01 160

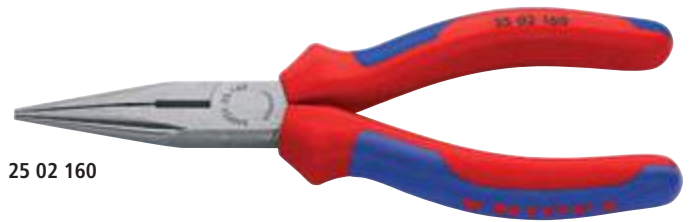

25 02 160



25 25 160



25 25 160

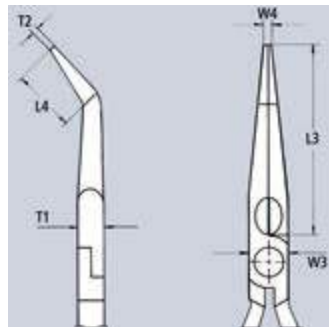
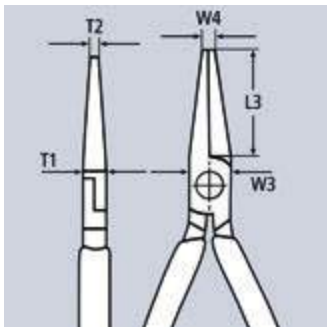

Article No.	EAN 4003773-	↔ mm		Pliers	Head	Handles	Cutting capacities		Dimensions						
							● Ø mm	● Ø mm	L3 mm	L4 mm	W3 mm	T1 mm	W4 mm	T2 mm	Δ g
25 01 125	015932	125		black atra-tmentized	polished	plastic coated	2.2	1.6	27.0		13.0	7.0	2.5	1.8	73
25 01 140	033158	140		black atra-tmentized	polished	plastic coated	2.5	1.6	42.0		15.0	8.0	2.5	2.0	90
25 01 160	033912	160		black atra-tmentized	polished	plastic coated	2.5	1.6	50.0		16.5	9.0	3.0	2.5	115
25 02 140	023159	140		black atra-tmentized	polished	with multi-component grips	2.5	1.6	42.0		15.0	8.0	2.5	2.0	109
25 02 160	023166	160		black atra-tmentized	polished	with multi-component grips	2.5	1.6	50.0		16.5	9.0	3.0	2.5	144
25 03 125	043065	125		chrome plated	chrome plated	plastic coated	2.2	1.6	27.0		13.0	7.0	2.5	1.8	72
25 05 140	035015	140		chrome plated	chrome plated	with multi-component grips	2.5	1.6	42.0		15.0	8.0	2.5	2.0	111
25 05 160	022817	160		chrome plated	chrome plated	with multi-component grips	2.5	1.6	50.0		16.5	9.0	3.0	2.5	144
25 06 160	033806	160	 	chrome plated	chrome plated	insulated with multi-component grips, VDE-tested	2.5	1.6	50.0		16.5	9.0	3.0	2.5	146
25 06 160 T	081432	160	 	chrome plated	chrome plated	insulated with multi-component grips, VDE-tested, with integrated insulated tether attachment point for a tool tether	2.5	1.6	50.0		16.5	9.0	3.0	2.5	155
25 21 160	050476	160	 	black atra-tmentized	polished	plastic coated	2.5	1.6	50.0	23.0	16.5	9.0	3.0	2.5	116
25 25 160	016007	160	 	chrome plated	chrome plated	with multi-component grips	2.5	1.6	50.0	23.0	16.5	9.0	3.0	2.5	143
25 26 160	052111	160	 	chrome plated	chrome plated	insulated with multi-component grips, VDE-tested	2.5	1.6	50.0	23.0	16.5	9.0	3.0	2.5	144

*Other tools with tethering can be found from page 272

Snipe Nose Side Cutting Pliers

Stork Beak Pliers

► Elastic tips: dimensionally stable even when twisted

- > Distortion-tolerant, elastic precision tips
- > Half-round, long, tapered jaws
- > With cutting edges (hardness approx. 61 HRC) for soft, medium-hard and hard wire
- > Cutting edges additionally induction-hardened, cutting edge hardness approx. 61 HRC
- > Vanadium electric steel, forged, multi stage oil-hardened
- > DIN ISO 5745

26 12 200 T / 26 15 200 T / 26 16 200 T / 26 22 200 T / 26 25 200 T / 26 26 200 T*

> Pliers with tether attachment point for mounting a fall protection

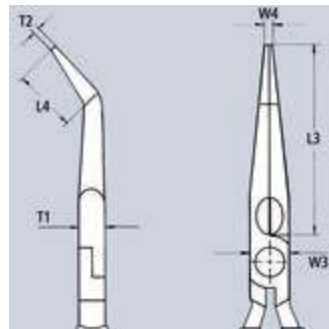
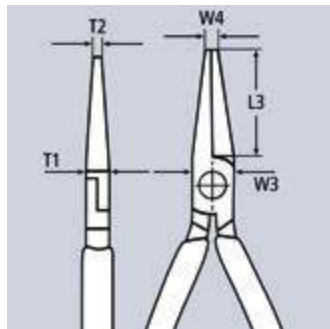

26 11 200



26 12 200



26 12 200 T



26 13 200



26 15 200



26 25 200



26 15 200 T



26 16 200



26 16 200 T



Article No.	EAN 4003773-	↔ mm		Pliers	Head	Handles	Cutting capacities		Dimensions						 g
							Ø mm	Ø mm	L3 mm	L4 mm	W3 mm	T1 mm	W4 mm	T2 mm	
26 11 200	022824	200		black atra- mentized	polished	plastic coated	3.2	2.2	73.0		18.0	9.5	3.0	2.5	170
26 12 200	023142	200		black atra- mentized	polished	with multi-component grips	3.2	2.2	73.0		18.0	9.5	3.0	2.5	201
26 12 200 T	079989	200		black atra- mentized	polished	with multi-component grips and integrated tether attach- ment point	3.2	2.2	73.0		18.0	9.5	3.0	2.5	200
26 13 200	040590	200		chrome plated		plastic coated	3.2	2.2	73.0		18.0	9.5	3.0	2.5	169
26 15 200	035022	200		chrome plated	chrome plated	with multi-component grips	3.2	2.2	73.0		18.0	9.5	3.0	2.5	198
26 15 200 T	079996	200		chrome plated	chrome plated	with multi-component grips and integrated tether attach- ment point	3.2	2.2	73.0		18.0	9.5	3.0	2.5	204
26 16 200	022831	200		chrome plated	chrome plated	insulated with multi-component grips, VDE-tested	3.2	2.2	73.0		18.0	9.5	3.0	2.5	206
26 16 200 T	081449	200		chrome plated	chrome plated	insulated with multi-component grips, VDE-tested, with integrat- ed insulated tether attachment point for a tool tether	3.2	2.2	73.0		18.0	9.5	3.0	2.5	215
26 17 200	016069	200		chrome plated	chrome plated	with dipped insulation, VDE-tested	3.2	2.2	73.0		18.0	9.5	3.0	2.5	212
26 21 200	022848	200		black atra- mentized	polished	plastic coated	3.2	2.2	73.0	23.0	18.0	9.5	3.0	2.5	171
26 22 200	023135	200		black atra- mentized	polished	with multi-component grips	3.2	2.2	73.0	23.0	18.0	9.5	3.0	2.5	197
26 22 200 T	080008	200		black atra- mentized	polished	with multi-component grips and integrated tether attach- ment point	3.2	2.2	73.0	23.0	18.0	9.5	3.0	2.5	202
26 25 200	035039	200		chrome plated	chrome plated	with multi-component grips	3.2	2.2	73.0	23.0	18.0	9.5	3.0	2.5	199
26 25 200 T	080015	200		chrome plated	chrome plated	with multi-component grips and integrated tether attach- ment point	3.2	2.2	73.0	23.0	18.0	9.5	3.0	2.5	205
26 26 200	022855	200		chrome plated	chrome plated	insulated with multi-component grips, VDE-tested	3.2	2.2	73.0	23.0	18.0	9.5	3.0	2.5	204
26 26 200 T	081456	200		chrome plated	chrome plated	with multi-component grips and integrated tether attach- ment point	3.2	2.2	73.0	23.0	18.0	9.5	3.0	2.5	215
26 27 200	016090	200		chrome plated	chrome plated	with dipped insulation, VDE-tested	3.2	2.2	73.0	23.0	18.0	9.5	3.0	2.5	220



Wire Strippers and Dismantling Tools

0.03 - 10
5 10 15 20

Made
in
Germany

0.03 - 10 mm²
KNIPEX
12 42 195

Insulation Strippers	18
Electronics Wire Stripping Shears	19
Electronics Wire Stripper	19
Diagonal Insulation Strippers	21
Precision Insulation Strippers with adapted blades	22
Insulation Strippers with adapted blades	23
KNIPEX MultiStrip 10 – Automatic Insulation Stripper	24
Self-Adjusting Insulation Strippers	25
KNIPEX PreciStrip16 – Automatic Insulation Stripper	26
KNIPEX NexStrip® – Multi-Tool for Electricians	27
Automatic Insulation Stripper	28
Automatic Insulation Stripper for flat cable	29
Automatic Stripping Pliers	29
Mini Wire Stripper	30
Wire Stripper for fibre optics cable	30
Stripping tool for fibre optics	31
Stripping Tweezers for coated wire	31
Stripping Pliers	32
KNIPEX StriX® – Insulation strippers with cable shears	33
Insulation Strippers	34
Stripping Tools with scalpel blade	34
Folding Knife for Electricians	35
Stripping Tools for spiral cutting	35
Stripping Tools	36
Stripping Tool for coax cables	36
Wire Stripping Tool for coax and data cable	37
Stripping Tool for flat and round cables	38
Stripping Tool for data cables	38
Universal Stripping Tools	39
Depth Stripping Tool	39
Universal Stripping Tool for building and industrial cables	40
KNIPEX ErgoStrip® – Universal Stripping Tool	41



Insulation Strippers

universal

- > For single, multiple and fine stranded conductors with plastic or rubber insulation up to 5.0 mm dia. or 10 mm² cable cross-section
- > Easy adjustment to the required diameter of solid or stranded wire with knurled screw and lock nut
- > Special tool steel, forged, oil-hardened

11 06 160 T*

- > Pliers with tether attachment point for mounting a fall protection

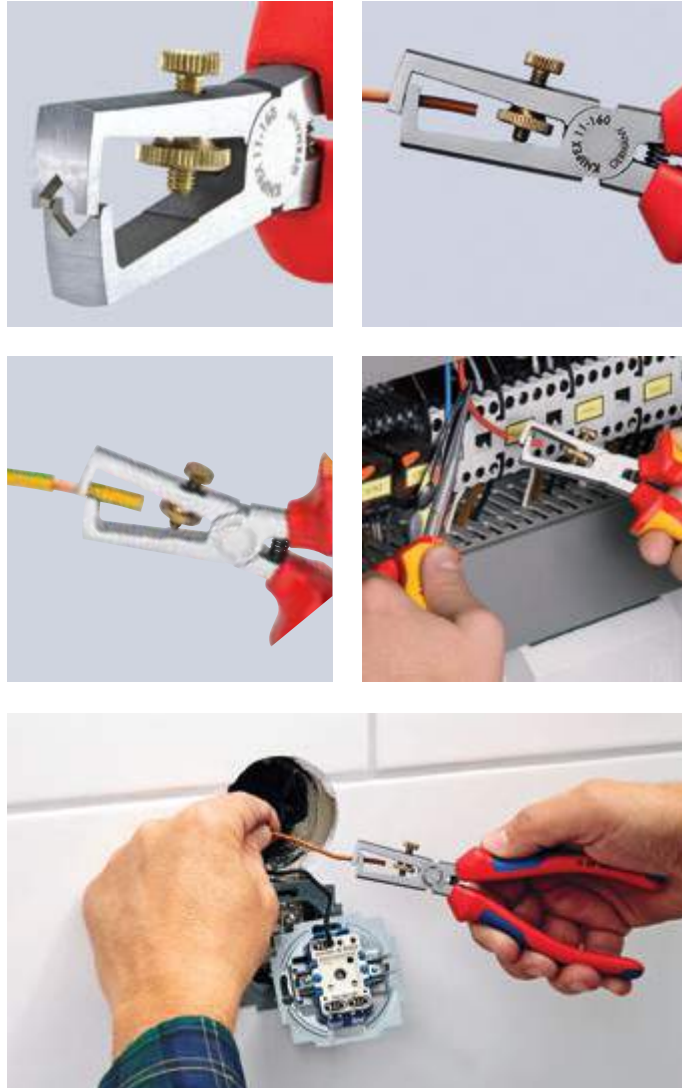

11 01 160



11 02 160



11 05 160



11 06 160 T



11 12 160

Article No.	EAN 4003773-	↔ mm	Pliers	Head	Handles	Stripping capacities			Δ g
						Ø mm	mm ²	AWG	
11 01 160	033868	160	black atramentized	polished	plastic coated	5.0	10	8	131
11 02 160	023180	160	black atramentized	polished	with multi-component grips	5.0	10	8	165
11 05 160	039570	160	chrome plated	chrome plated	with multi-component grips	5.0	10	8	157
11 06 160	021933	160	⚠ 1000 V ⚡ M	chrome plated	insulated with multi-component grips, VDE-tested	5.0	10	8	200
11 06 160 T	081418	160	⚠ 1000 V ⚡ M	chrome plated	insulated with multi-component grips with integrated insulated tether attachment point, VDE tested	5.0	10	8	180
11 07 160	015499	160	⚠ 1000 V ⚡ M	chrome plated	with dipped insulation, VDE-tested	5.0	10	8	180
11 12 160	034964	160	black atramentized	polished	with multi-component grips	5.0	10	8	156
11 09 01	052326	Set of spare parts (screw and nut) for 11 160							

Electronics Wire Stripping Shears

- > For cutting and stripping solid, multicore and finely stranded conductors with conductor cross-section up to 0.75 mm²
- > Pointed head of shears above the wire stripping hole for the accurate cutting of fine wire in confined places
- > Easy adjustment to the required diameter of solid or stranded wire with knurled screw and lock nut
- > With opening spring
- > Special tool steel, oil-hardened



11 82 130

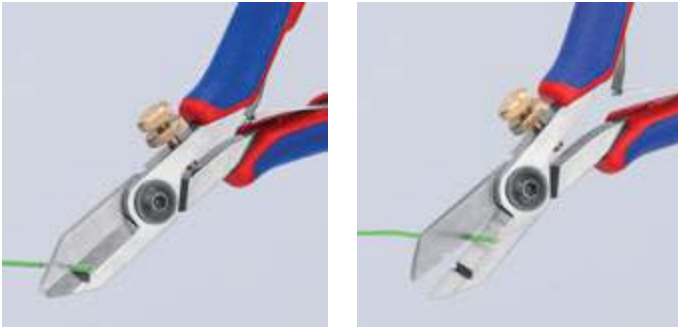

Article No.	EAN 4003773-	↔ mm		Head	Handles	Stripping capacities mm ²	⚖ g
11 82 130	071648	140	MM	polished	with multi-component grips	0.01 – 0.75	85

Electronics Wire Stripper

- > For single, multiple and fine stranded cables having a diameter from 0.1 up to 0.8 mm, with plastic or rubber insulation
- > Easy adjustment to the required diameter of solid or stranded wire with knurled screw and lock nut
- > With opening spring
- > The mirror polish together with a fine film of oil offer effective rust protection – no circuit faults caused by peeling chrome from plated tools
- > Special tool steel, forged, oil-hardened



11 92 140



Article No.	EAN 4003773-	↔ mm		Head	Handles	Stripping capacities Ø mm	⚖ g
11 92 140	016908	140	MM	mirror polished	with multi-component grips	0.1 – 0.8	99



Diagonal Insulation Strippers

- ▶ With long cutter
- ▶ High cutting capacity due to high leverage joint
- > Precision stripping holes for single conductors of 1.5 and 2.5 mm²
- > Convenient cutting of NYM cables up to 5 x 2.5 mm²
- > Long tips for ultra fine cutting work also in confined areas
- > Induction-hardened precision blades, cutting edge hardness approx. 60 HRC
- > Vanadium electric steel, forged, multi stage oil-hardened



14 22 160



14 25 160



14 26 160



— elongated cutting edge

— improved transmission ratio

Article No.	EAN 4003773-	↔ mm	Pliers	Head	Handles	Stripping capacities mm ²	AWG	Cutting capacities		
								⊙ Ø mm	⊙ Ø mm	⚖ g
14 22 160	034988	160	black atramentized	polished	with multi-component grips	1.5 / 2.5	16 / 14	2.5	1.5	206
14 25 160	028697	160	chrome plated	chrome plated	with multi-component grips	1.5 / 2.5	16 / 14	2.5	1.5	224
14 26 160	040279	160	chrome plated	chrome plated	insulated with multi-component grips, VDE-tested	1.5 / 2.5	16 / 14	2.5	1.5	216

Precision Insulation Strippers

with adapted blades

- > Form-fit stripping also of difficult-to-remove insulating materials made of PTFE, silicone, Radox®, Kapton® and rubber; multi-layer too
- > A second pair of blades holds the remaining insulation reliably in place
- > Replaceable shaped blade adapted precisely to the respective conductor cross-section
- > With length stop for constant stripping length during repetitive work
- > Blade: special tool steel, oil-hardened
- > Pliers body: steel



12 12 02



12 12 11



12 12 13



Precise cutting of the insulation to a complete extent



Positive stripping thanks to precise shape of the blades



12 12 02 with cable guide and length stop

12 12 02

- > With additional cable guide for exact positioning of the cable in the stripping area of the blade

12 12 11 / 12 12 12 for solar cable

- > Specially adapted to multilayer and Radox® insulation
- > With additional cable support for a better centring of multi-layer insulated conductors in the stripping profiles

12 12 13 / 12 12 14

- > Especially for cables in accordance with the American specification (AWG)

Maximum cable cross-section (in mm²) per profile:



12 19 02



12 19 06



12 19 10



12 19 11



12 19 12

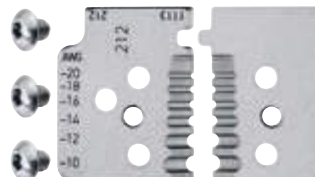

12 19 13

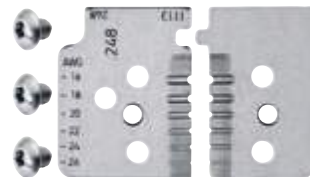

12 19 14

Radox® is a registered trademark of Huber & Suhner AG
Kapton® is a registered trademark of E. I. du Pont de Nemours and Company

Principle of operation with adapted blades

Properly and precise stripping with an annular cut through the complete insulation. This is particularly important with conductors, which must be stripped precisely.

This works without any problem even with difficult insulating materials made of PTFE, Radox® and multilayer insulations.

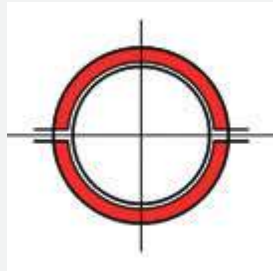

Precisely and reliably

Two pairs of blades (1) cut the insulation to a complete extent. Then the blade pairs move apart, and thus the insulation is removed form-fit (2). The pliers open automatically after the stripping procedure.

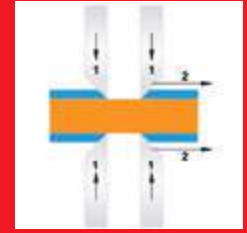

Article No.	EAN 4003773-	↔ mm		Pliers	Handles	Stripping capacities		AWG	Δg
						mm ²			
12 12 02	048077	195				0.03 - 0.09 / 0.14 / 0.38 / 0.57 / 1 / 1.5 / 2.08		32 – 14	447
12 12 06	049005	195	MM	burnished	with multi-component grips	0.14 - 0.25 / 0.75 / 1.5 / 2.5 / 4 / 6		26 – 10	445
12 12 10	049012	195				2.5 / 4 / 6 / 10		14 – 8	445
12 12 11	062998	195				1.5 / 2.5 / 4 / 6		16 – 10	449
12 12 12	073758	195	MM	burnished	with multi-component grips	4 / 6 / 10		12 – 8	450
12 12 13	077534	195						10 / 12 / 14 / 16 / 18 / 20	450
12 12 14	077541	195	MM	burnished	with multi-component grips			16 / 18 / 20 / 22 / 24 / 26	450
12 19 02	049036	1 set of spare blades for 12 12 02							
12 19 06	049043	1 set of spare blades for 12 12 06							
12 19 10	049050	1 set of spare blades for 12 12 10							
12 19 11	063001	1 set of spare blades for 12 12 11							
12 19 12	073765	1 set of spare blades for 12 12 12							
12 19 13	077558	1 set of spare blades for 12 12 13							
12 19 14	077565	1 set of spare blades for 12 12 14							

Insulation Strippers

with adapted blades

- > With replaceable blades for 4 (adapted to diameters) or 6 (adapted to cross-sections) different conductor cross-sections
- > Leave wire undamaged thanks to precision-ground blade shapes, even multi-stranded conductors are stripped gently
- > During stripping, the wire is held firmly by clamping jaws
- > With length stop for constant stripping length during repetitive work
- > A spring leads the stripper back to the starting position
- > Blade: special tool steel, oil-hardened
- > Pliers body: aluminium



12 11 180



12 11 180: wire diameter in mm

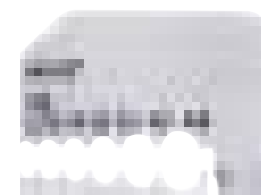

12 21 180: wire cross-sections in mm²

Article No.	EAN 4003773-	↔ mm		Pliers	Handles	Stripping capacities		AWG	Δg
						Ø mm	mm ²		
12 11 180	000792	180				0.5 / 1.2 / 1.6 / 2.0			368
12 21 180	000815	180	MM	black lacquered	with plastic grips	0.5 – 0.75 / 1 / 1.5 / 2.5 / 4 / 6		20 – 18 / 18 / 16 / 14 / 12 / 10	335
12 19 180	022145	1 pair of spare blades for 12 11 180							
12 29 180	022152	1 pair of spare blades for 12 21 180							

KNIPEX MultiStrip 10

PATENTED

Automatic Insulation Stripper

- ▶ Stripping without re-adjustment from 0.03 to 10.0 mm²
- ▶ Recessed wire cutter
- ▶ Universal blade geometry -robust and more durable
- ▶ Ideal grip design with excellent haptics

- > Fully automatic adjustment to all single-, multi- and fine-stranded conductors with standard insulation throughout the entire capacity range from 0.03 to 10.0 mm²
- > No manual fine adjustment necessary
- > No damage to the conductors
- > The clamping jaws made of steel hold the cable in a way that prevents slipping without damaging the remaining insulation
- > With recessed wire cutter for Cu and Al conductors, stranded up to 10 mm² and single wire up to 6 mm²
- > Particularly smooth-running mechanics and very low weight
- > Replaceable blades block and length stop
- > Handle with soft-plastic zone for a steady grip
- > Body: plastic, fibreglass-reinforced
- > Blade: special tool steel, oil-hardened



12 42 195

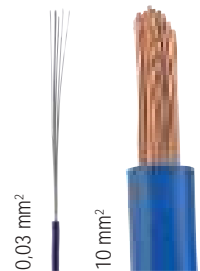

Steel clamping jaws avoid slipping of the cable



Precise stripping from 0.03 to 10 mm² without re-adjustment

Patented mechanics

The incision depth of the stripping blade adjusts fully automatically to the diameter of the wire and accordingly also to the thickness of all standard insulating materials.

There is no need for any manual adjustment which is still necessary when other conventional pliers with a wide wire-stripping range are used.



Wire cutter for multiple stranded wire cables up to 10.0 mm²



Mode of operation of straight cutters

An incision is made in the red area only.

Not suitable for highly-flexible or armoured insulation materials or for multi-layered insulation.

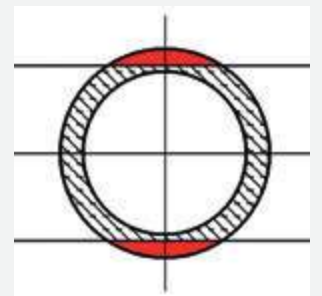

Article No.	EAN	↔ mm		Stripping capacities mm ²	AWG	⚖ g
12 42 195	054580	195	MM	0.03 – 10	32 – 8	136
12 49 04	053071	Torsion spring for 12 40/50 200				
12 49 21	057581	Spare blades block for 12 42 195				
12 49 23	057604	Spare length stop for 12 42 / 52 195				

Self-Adjusting Insulation Strippers

- > For single, multiple and fine stranded conductors with plastic or rubber insulation
- > Adapts automatically to the respective cable cross-section; prevents damage to the conductor
- > Cutting depth can be adjusted for different insulation materials
- > With wire cutter for copper and aluminium wires, multiple stranded up to 10 mm² and single stranded up to 6 mm²
- > Smoothly operating mechanism
- > Stripping blades and clamping jaws easily replaceable
- > Low weight
- > Body: plastic, fibreglass-reinforced
- > Blade: special tool steel, oil-hardened

12 40 200

- > For thin ribbon cables up to 10.0 mm width in a single pass



12 40 200



12 40 200: Adjustable length stop



12 40 200: Precise stripping prevents damage to the conductor



Article No.	EAN	↔ mm		Stripping capacities mm ²	AWG	Length stop mm	△ g
12 40 200	4003773-026662	200	MM	0.03 – 10	32 – 8	3.0 – 18.0	202
12 49 01	026679	1 pair of spare blades for 12 40 200					
12 49 02	026686	1 pair of spare clamping jaws for 12 40 200					
12 49 03	026693	Spare length stop for 12 40 200					
12 49 04	053071	Torsion spring for 12 40/50 200					
12 49 05	053088	Coil spring in the head for 12 40/50 200					
12 59 01	034414	1 pair of spare blades for 12 50 200					
12 59 02	034421	1 pair of spare clamping jaws for 12 50 200					

KNIPEX PreciStrip16

Properly stripped away: with deft precision, strip everything from very fine to thick cables with stranded or solid conductors

- ▶ Simple, precise stripping of fine wires and solid round cables with a wide capacity range from 0.08 to 16 mm² with only one pair of pliers
 - ▶ Good grip provided by semi-circular grooved metal holding clamps and exact cut from parabolic stripping blade
 - ▶ A patented automatism regulates the depth of the cut; the neutral point of the automatism can be adjusted in fine steps in special operating conditions (insulation material, temperature)
- > With cable cutter for stranded wire from 0.08 to 16 mm²
 - > With tether attachment point, suitable for KNIPEX Tethered Tools accessories
 - > Inscription area for customisation
 - > With adjustable length stop for precision work repeated accurately each time
 - > Comfortable operation with ergonomic dual-component handle
 - > Easily replaceable blade cassette



12 52 195

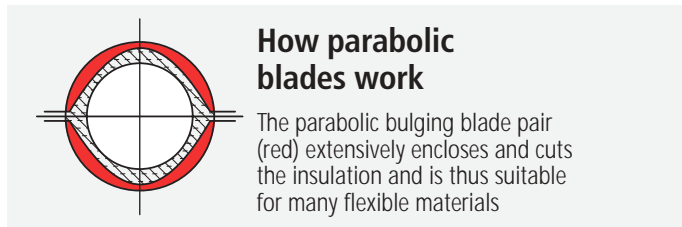

Semi-circular grooved holding clamp for better grip that holds practically any insulation material securely in place



For special requirements, such as particularly hard or soft insulation materials, optimum fine adjustments can be made using the adjusting wheel with its tactile locking positions



With cable cutter on the top side for up to 16 mm²

Article No.	EAN 4003773-	↔ mm	⊗ mm ²	⊗ AWG	⚖ g
12 52 195	085829	195	0.08 – 16	28 – 6	180
12 52 195 SB	085997	195	0.08 – 16	28 – 6	180
12 49 31	086000	Spare blade pair for 12 52 195			10

KNIPEX NexStrip®

Multi-Tool for Electricians

Wire stripper with three functions: stripping wire up to 10 mm², crimping capacity of 4 mm² or 2 x 2.5 mm² and cutting capacity of 10 mm²

- ▶ Precise stripping: automatically adapts to the respective cable diameter and ensures consistent stripping lengths with the adjustable length stop especially with repetitive work
 - ▶ Perfect crimping: fast and even square crimping for individual wire ferrules, the ratchet crimping mechanism guarantees the required crimping pressure
 - ▶ Multi-component grips ensure non-slip, comfortable handling
- > Quick, precise square crimp of single wire ferrules according to DIN 46228 parts 1+4, self-adjusts for sizes 0.25 – 4 mm² / 2 x 2.5 mm² – allows for quick crimping between different sizes
 - > Repetitive, high crimping quality due to ratcheting mechanism with a complete crimping cycle
 - > Stripping with fine adjustment – for optimal adjustment to special materials or temperature conditions for flexible and solid conductors between 0.03 and 10 mm² (AWG 32 – 8)
 - > Cleanly cuts conductors up to 10 mm² (AWG 8)
 - > High-quality housing made of glass fibre reinforced plastic
 - > For the electrical trade: for domestic installations and wiring of electronical devices, such as PLC (programmable logic controller)



12 72 190



The ratchet crimping mechanism ensures the correct crimping pressure.

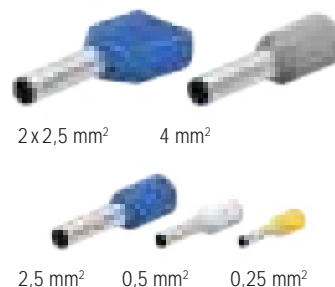

With cable cutter for conductors up to 10 mm².



Automatic stripping up to 10 mm².



Square crimping die for wire ferrules of 0.25 – 4 mm².



The fine adjustment feature allows reliable stripping in all operating conditions like extreme temperatures or special insulating material.

Article no.	EAN 4003773-	↔ mm	Handles	Application	Capacity mm ²	AWG	⚖ g
12 72 190	088165	190	non-slip	Cutting	Cutting up to 10	8	170
				Stripping	Stripping from 0.03 to 10	32 – 8	
				Square compression	Crimping of single wire ferrules from 0.25 to 4 Crimping of twin wire ferrules 2 x 2,5		
12 49 21	057581	Spare blades block for 12 72 190					8
12 49 23	057604	Spare length stop for 12 72 190					46

Automatic Insulation Stripper

Work faster: Adjusts automatically to most cable types, with fine adjustment for special materials

- ▶ Strips cables with standard materials without any need for manual adjustment
 - ▶ Fine adjustment enables accurate setting of the blades to special materials or temperature requirements
 - ▶ Compact, handy and lightweight tool for common cable cross-sections and insulating materials
-
- > For single, multiple and fine stranded cables of 0.2 up to 6 mm² with standard insulation
 - > Narrow head style for use in confined areas
 - > With wire cutter for copper and aluminium wires up to 2.5 mm²
 - > With adjustable length stop from 6.0 – 18.0 mm for cutting the same stripping lengths during repetitive work
 - > Body: plastic, fibreglass-reinforced
 - > Blades: special tool steel, oil-hardened, interchangeable



12 62 180

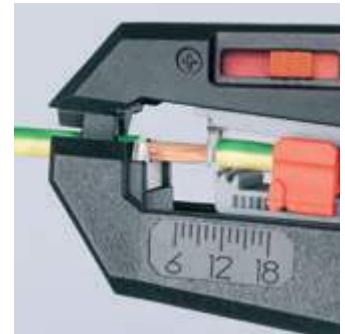

Article No.	EAN	↔ mm		Stripping capacities mm ²	AWG	△ g
12 62 180	4003773-054573	180	MM	0.2 – 6	24 – 10	151
12 69 21	060093	1 pair of spare blades for 12 62 180				
12 69 23	067115	Spare length stop for 12 62 180				

Automatic Insulation Stripper for flat cable

- > For PVC insulated flat cables up to a max. 12 mm width and 0.75 to 2.5 mm²
- > Adapts automatically to various conductor heights; prevents damage to the conductor
- > Long stripping lengths possible
- > Blade replaceable
- > Smoothly operating mechanism
- > Low weight
- > Body: plastic, fibreglass-reinforced
- > Blade: special tool steel, oil-hardened



12 64 180

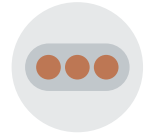

Sectional view of an ribbon cable

Article No.	EAN 4003773-	↔ mm		Stripping capacities mm ²	AWG	△ g	
12 64 180	073284	180	MM	0.75 – 2.5	18 – 14	125	
12 69 31	073932	1 pair of spare blades for 12 64 180					

Automatic Stripping Pliers

- ▶ For control and sensor cables / actuator cables, also for stripping flexible feed cables and extension cable
 - ▶ Automatic adjustment to cable diameters between 4.4 mm and 7.5 mm
 - ▶ No damage to the inner conductor or shield braid
- > For oil-resistant, halogen-free control and sensor / actuator cables with multicore cable design
 - > Shielded and unshielded
 - > Suitable for highly flexible TPE-U-pipes, PUR and PVC cable sheathing, rubber leads such as H05 etc.
 - > Long stripping lengths possible
 - > Body: plastic, fibreglass-reinforced
 - > Blades: special tool steel, oil-hardened, interchangeable



12 74 180 SB



Sectional view of an extension cord



Complex cutter design for precise and damage-free stripping of round cables



Required stripping length easy to read off

Article No.	EAN 4003773-	↔ mm		Stripping capacities Ø mm	△ g	
12 74 180 SB	082323	175	MM	4.4 – 7.5	145	
12 79 31	082682	1 pair of spare blades for 12 74 180 SB				

Mini Wire Stripper

- > Precise stripping, stepwise adjustment to the conductor diameters
- > With wire cutter
- > Adjustable length stop from 4.0 - 15.0 mm
- > With locking device
- > Housing: plastic, impact-proof

12 80 040 SB

- > For thin copper conductors dia. 0.12 to 0.4 mm

12 80 100 SB

- > For thin copper conductors dia. 0.3 to 1.0 mm



12 80 100 SB

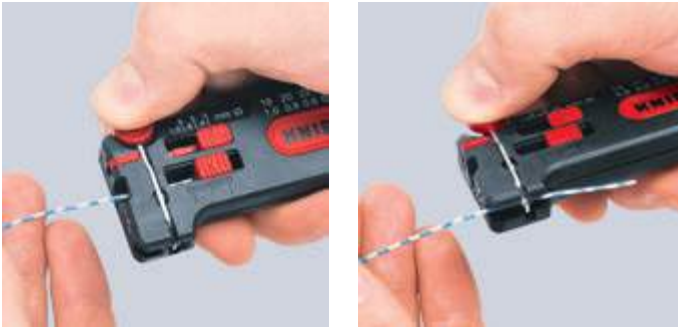

Article No.	EAN 4003773-	↔ mm		Stripping capacities Ø mm	AWG	△ g
12 80 040 SB	071655	100	MM	0.12 – 0.4	36 – 26	35
12 80 100 SB	043119	100		0.3 – 1.0	28 – 18	34

Wire Stripper for fibre optics

- > To remove primary and secondary coating of fibre optics
- > Chrome vanadium electric steel in special quality, oil-hardened



12 82 130 SB



Article No.	EAN 4003773-	↔ mm	Pliers	Handles	Stripping capacities Ø mm	△ g
12 82 130 SB	050094	130	burnished	with plastic grips	primary-coating: 0.125 mm; secondary-coating: 0.250 mm	75

Stripping tool for fibre optics cable

- > To remove primary coating of fibre optics with \varnothing 0.125 mm
- > Blade \varnothing 0.16 mm, hole for cable feed \varnothing 0.35 mm
- > Adjustable length stop for 5 – 45 mm

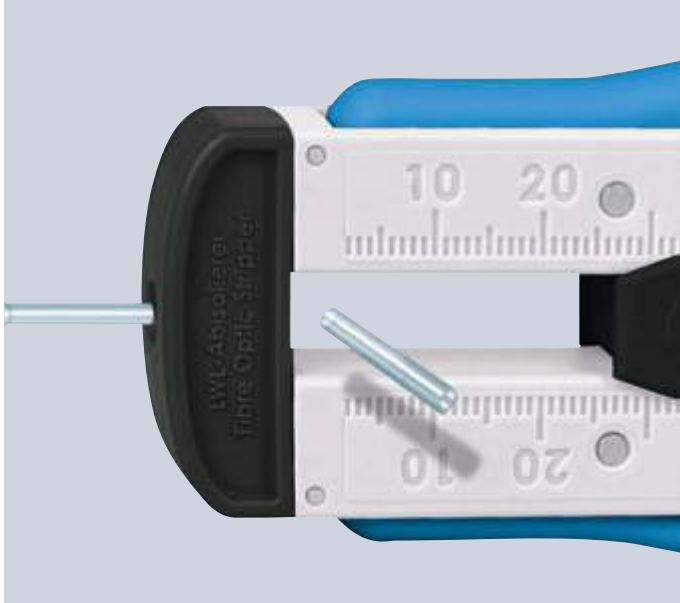

Replaces article 12 85 100

Article no.	EAN 4003773-	↔ mm	Stripping capacities \varnothing mm	⚖ g	€
12 85 110 SB	287872	110	0.125	70	56.00

Stripping Tweezers for coated wire

- > For stripping off varnished insulation on copper wires
- > Blades for other wire diameters available as spare parts
- > Tweezers body: spring steel, oil-hardened
- > Handle shells: plastic



15 11 120

Article No.	EAN 4003773-	↔ mm	Stripping capacities \varnothing mm	⚖ g
15 11 120	015550	120	0.6	34
15 19 005	021551	1 pair of spare blades for 15 11 120 \varnothing 0.5 mm		
15 19 006	021568	1 pair of spare blades for 15 11 120 \varnothing 0,6 mm		
15 19 008	021575	1 pair of spare blades for 15 11 120 \varnothing 0,8 mm		
15 19 010	021582	1 pair of spare blades for 15 11 120 \varnothing 1,0 mm		

Stripping Pliers

Multifunctional – cutting and stripping with one pair of pliers

- ▶ For time-saving stripping of all round sheathed and damp-proof installation cables (e.g. NYM cable)
 - ▶ Simplified access especially into deep mounted junction boxes thanks to slim head design and optimally angled cable sheath cutter
 - ▶ Strip cables easily and without damage thanks to circular cutting edge with depth limiter
- > Suitable for universal use: precision wire stripping holes for conductors from 1.5 and 2.5 mm²
- > With side cutters for cutting and trimming conductors, wires, small screws and nails
- > All cutters additionally induction-hardened to approx. 61 HRC for high wear resistance
- > 30 % lighter than comparable pliers
- > Vanadium electric steel, forged, multi stage oil-hardened



13 42 165

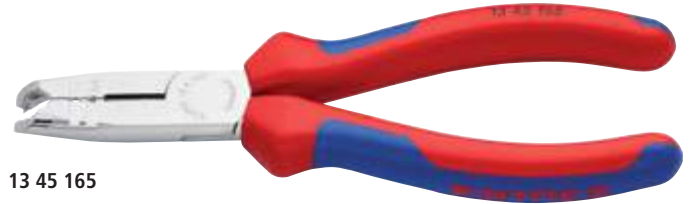

13 45 165



13 46 165



Cutting cable up to Ø 13 mm



Cutting when shortening single conductors



Stripping deep down in a flush-mounted junction box



Wire stripping holes for 1.5 and 2.5 mm² conductors

Article No.	EAN 4003773-	↔ mm		Pliers	Head	Handles	Dismantling capacities Ø mm	Stripping capacities mm ²	☉ Ø mm	☾ Ø mm	⚖ g
13 42 165	079675	165		black atramentized	polished	with multi-component grips	8.0 – 13.0	0.75 – 1.5 / 2.5	3.2	2.2	176
13 45 165	079682	165		chrome plated	chrome plated	with multi-component grips	8.0 – 13.0	0.75 – 1.5 / 2.5	3.2	2.2	176
13 46 165	079699	165	 	chrome plated	chrome plated	insulated with multi-component grips, VDE-tested	8.0 – 13.0	0.75 – 1.5 / 2.5	3.2	2.2	190

KNIPEX StriX®

PATENTED

Insulation strippers with cable shears

Two functions in one pair of pliers

- > For single, multiple and fine stranded conductors with plastic or rubber insulation up to 5.0 mm dia. or 10 mm² cable cross-section
- > Increments in the jaw provide a visual orientation aid for stripping consistent lengths (11 mm and 16 mm)
- > Easy adjustment to the required diameter of solid or stranded wire with knurled screw and lock nut
- > Shear blade for cutting copper and aluminium cable up to Ø 15 mm (5 x 2.5 mm²)
- > Cutting edges additionally induction-hardened, cutting edge hardness approx. 57 HRC
- > Slim dimensions for easy access
- > Bolted joint: precise, zero backlash operation of pliers
- > High-grade special tool steel, forged, multi stage oil-hardened

13 66 180 T*

- > Pliers with tether attachment point for mounting a fall protection



13 62 180



13 66 180



13 66 180 T



Induction-hardened precision cutter



Length mark: Profiling on the inner side helps when stripping wire in standard lengths (11 mm and 16 mm)



Induction-hardened shear blade with precisely ground cutting edges for crush-free cutting of copper and aluminium cables of up to Ø 15 mm (5 x 2.5 mm²)



Lock nut prevents any unintentional adjustment



Article No.	EAN	↔ mm		Pliers	Handles	Stripping capacities			Δ g
						Ø mm	mm ²	AWG	
13 62 180	081302	180		black atramentized	with multi-component grips	5.0	10	8	200
13 66 180	081319	180	⚡ 1000 V	chrome plated	insulated with multi-component grips, VDE-tested	5.0	10	8	215
13 66 180 T	081906	180	⚡ 1000 V	chrome plated	insulated with multi-component grips with integrated insulated tether attachment point, VDE tested	5.0	10	8	215

*Other tools with tethering can be found from page 272

Insulation Strippers

- > For stripping thin cables
- > Accurate boring to match diameter of wire, precise stripping prism; non-adjustable
- > With opening spring
- > Chrome vanadium electric steel, forged, oil-hardened



15 61 160



Article No.	EAN 4003773-	↔ mm	MM	Head	Handles	Stripping capacities	
						Ø mm	Δ g
15 51 160	044451	160		polished		0.5	101
15 61 160	014843	160	MM	polished	plastic coated	0.6	102
15 81 160	015574	160				0.8	102

Stripping Tools

with scalpel blade

- > For stripping all common round cables
- > Self-tightening holding lever
- > With adjusting screw for cutting depth adjustment
- > Turnable blade for circular and longitudinal cutting
- > Spare blade inside the handle
- > Secure grip due to soft component material on handle and holding lever to avoid slipping
- > Housing: plastic, impact-proof



16 20 16 SB



16 20 165 SB

16 20 165 SB

- > With knife and hook blade, protective cap included



Article No.	EAN 4003773-	↔ mm	MM	Stripping capacities	
				Ø mm	Δ g
16 20 16 SB	060451	130	MM	4 – 16	70
16 20 28 SB	060468	130		8 – 28	95
16 20 165 SB	043133	165	MM	8 – 28	85
16 29 165	043140	Spare blade for 16 20 16 SB / 16 20 28 SB / 16 20 165 SB			

Folding Knife for Electricians

Always to hand: the high-quality all-purpose cutter

- ▶ Universal folding cutter for everyday use
- ▶ Durable and robust: top quality, extremely sharp blade – Made in Solingen
- > Ergonomic handle shape for comfortable holding and easy guidance
- > Handle made from robust, shock-resistant plastic
- > Good power transmission during use
- > Stable blade
- > Tether attachment at the end of the cutter allows a fastener to be attached; also suitable for KNIPEX Tethered Tools
- > Blade made of stainless steel



16 20 50 SB

Article No.	EAN 4003773-	↔ mm	Blade length mm	⚖ g
16 20 50 SB	082705	120	80	85



Easy opening thanks to the practical diamond-shaped grip on the blade



For KNIPEX Tethered Tools: the tether attachment on the handle allows a fastener to be attached



The Electricians' Folding Cutter is quickly available to hand and is suitable for all the usual cutting tasks

Stripping Tools

for spiral cutting

- > For dismantling round cable sheaths made of PVC, rubber, silicone or PTFE from 6.0 - 29.0 mm dia.
- > Self-tightening holding lever
- > With knurled nut for cutting depth adjustment
- > Changing from circular to longitudinal cutting by turning the tool body
- > Spiral cutting for removing intermediate pieces
- > Replaceable blade
- > Housing: plastic, impact-proof



16 30 145 SB



Setting the tool for circular cut



Longitudinal cut



Spiral cutting

Article No.	EAN 4003773-	↔ mm	MM	Stripping capacities Ø mm	⚖ g
16 30 135 SB	033349	135			6 – 29
16 30 145 SB	081029	150	19 – 40	140	
16 39 135	027317	Spare blade for 16 30 135 SB / 16 30 145 SB			

Stripping Tools

- > For dismantling round cables exceeding 25.0 mm dia.
- > Removes all sheaths of standard cables
- > Suitable for longitudinal and circular cutting
- > Cutting depth can be adjusted up to 5.0 mm
- > Replaceable blade (both sides can be used)
- > Tool body: plastic, fibreglass-reinforced



16 40 150



Setting the tool for longitudinal cut



Longitudinal cut



Turning the tool for circumferential cut



Circular cut

Article No.	EAN 4003773-	↔ mm	Stripping capacities Ø mm	⚖ g
16 40 150	026709	150	> 25	210
16 49 150	026716	Spare blade for 16 40 150		



Adjustable cutting depth

Stripping Tool for coax cables

- > For stripping coax cables (RG 58, RG 59 and RG 62)
- > For stripping outer sheath, shield and insulation in a single process
- > With three built-in blades
- > The cutting depth of each blade can be adjusted individually by means of a hexagonal key (Allen key)
- > The blade spacing remains constant
- > Housing: plastic, impact-proof



16 60 05 SB

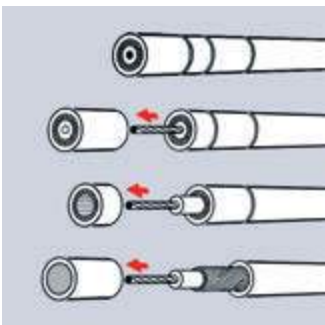

Stripping of a Coax cable in three steps

Article No.	EAN 4003773-	↔ mm		Cable type	⚖ g
16 60 05 SB	044888	105	MM	RG 58, RG 59 + RG 62	75

Wire Stripping Tool for coax and data cable

- > Universal stripping tool for Coax cables RG 59, RG 6, RG 7, RG 11
- > For stripping outer sheath, shield and insulation in a single process
- > Adjustable stripping blade for data cable
- > Two stripping blades for cutting and stripping telephone ribbon cable (4P/6P/8P) in a single operation
- > Integrated blade for cutting data cables
- > Housing: plastic, impact-proof



16 60 06 SB



Article No.	EAN 4003773-	↔ mm		Cable type	⚖ g
16 60 06 SB	077961	125	MM	RG 59, RG 6, RG 7, RG 11	100

Stripping Tool for coax cables

- > For stripping all common coax cables between 4.8 - 7.5 mm dia. (e.g. for TV- and satellite antenna), also suitable for PVC round cable 3 x 0.75 mm²
- > With length scale 5.0 - 20.0 mm
- > Double shell, folding back stripping tool
- > With opening spring and locking device
- > Body: plastic, fibreglass-reinforced



16 60 100 SB

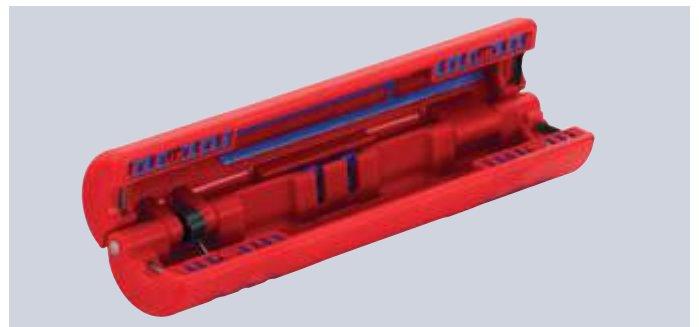

Article No.	EAN 4003773-	↔ mm	Stripping capacities Ø mm	⚖ g
16 60 100 SB	040811	100	Coax cables 4.8 – 7.5 round cables 3 x 0.75 mm ²	22

Stripping Tool for flat and round cables

- > For flat cables up to 12 mm in width
- > For stripping all common round and damp-proof installation cables Ø 4.0 to 13.0 mm (e.g. NYM cable 3 x 1.5 mm² up to 5 x 2.5 mm²)
- > Stripping device for cross-sections 0.8 / 1.5 / 2.5 mm² (AWG 20 / 16 / 14)
- > With opening spring and locking device
- > For use in confined and difficult to access work areas
- > Also for use in conduit and distribution boxes
- > Body: plastic, fibreglass-reinforced



16 64 125 SB

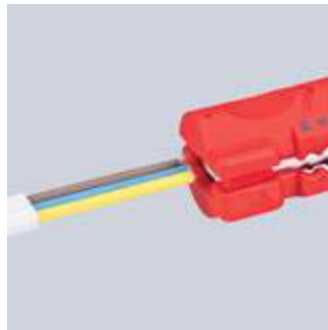

Article No.	EAN 4003773-	↔ mm	∩	Stripping capacities		Types of cables	⚖ g
				Ø mm	mm ²		
16 64 125 SB	076933	125	∩	4 – 13	0.8 – 2.5	flat cable 12 mm / round cable Ø 4 – 13 mm	48

Stripping Tool for data cables

- > For stripping UTP and STP data cables with diameters of 4.5 to 10.0 mm
- > Stripping device for cross-sections 0.2 / 0.3 / 0.8 / 1.5 / 2.5 / 4 mm²
- > Double shell, folding back stripping tool
- > With opening spring and locking device
- > Practical clip for easy transport
- > Body: plastic, fibreglass-reinforced
- > Blades: special tool steel, oil-hardened, TiN-coated



16 65 125 SB



Article No.	EAN 4003773-	↔ mm	∩	Stripping capacities		Types of cables	⚖ g
				Ø mm	mm ²		
16 65 125 SB	043157	125	∩	4.5 – 10	0.2 – 4	CAT 5, CAT 6, CAT 7, Twisted-Pair (UTP/STP)	50

Universal Stripping Tools

- > For stripping all common round and damp-proof installation cables between 8.0 – 13.0 mm dia. (e.g. 3 x 1.5 mm² up to 5 x 2.5 mm²)
- > Also for use in conduit and distribution boxes
- > Double shell, folding back stripping tool
- > With opening spring and locking device
- > Practical clip for easy transport
- > Body: plastic, fibreglass-reinforced

16 85 125 SB

- > With additional blade for longitudinal cuts; telescopic blade inside; stripping device for cross-sections 0.2 / 0.3 / 0.8 / 1.5 / 2.5 / 4 mm²; with integrated cable guide for longitudinal cut. This enables rigid insulation (e.g. halogen-free) to be stripped more easily



16 80 125 SB



16 85 125 SB



Article No.	EAN 4003773-	↔ mm		Stripping capacities		Types of cables	⚖ g
				Ø mm	mm ²		
16 80 125 SB	040828	125	///	8 – 13		round cable, e.g.: 3 x 1,5 mm ² up to 5 x 2,5 mm ²	75
16 85 125 SB	060444	125	///	8 – 13	0.2 – 4	round cable, e.g.: 3 x 1,5 mm ² up to 5 x 2,5 mm ²	79

Depth Stripping Tool

- > Long, ergonomic design for work in deep connector sockets



16 80 175 SB

Article No.	EAN 4003773-	↔ mm	Stripping capacities		⚖ g
			Ø mm		
16 80 175 SB	084129	175	8 – 13		90

Universal Stripping Tool for building and industrial cables

- > With opening spring and locking device
- > For stripping all common round and damp-proof installation cables between 8.0 – 13.0 mm dia. (e.g. 3 x 1.5 mm² up to 5 x 2.5 mm²)
- > Also for use in conduit and distribution boxes
- > Body: plastic, fibreglass-reinforced
- > For use in confined and difficult to access work areas
- > Specially suitable for larger cross-sections and for difficult insulating materials
- > No adjustment of blades to cutting depth required
- > Stripping device for conductors and strands 1.5 mm² and 2.5 mm²
- > Two-way length stop (ideal for right and left-handers)
- > Fastening device on the end of the handle (drop protection system)



16 90 130 SB



Article No.	EAN 4003773- 076940	↔ mm	↔ mm	Stripping capacities		Types of cables	△ g
				Ø mm	mm ²		
16 90 130 SB		130	MM	8 – 13	1.5 / 2.5	round cable, e.g.: 3 x 1,5 mm ² up to 5 x 2,5 mm ²	47



KNIPEX ErgoStrip®

PATENTED

Universal Stripping Tool

- ▶ For the fast and precise stripping of all common round and damp-proof installation cables (e.g. NYM cable 3 x 1.5 mm² up to 5 x 2,5 mm²), data cable (e.g. twisted pair) and coax cable
 - ▶ Innovative, ergonomic pistol grip design for easy cutting, stripping and longitudinal cut of the sheath
- > Conical, slimmed down tool ends for better access in confined areas
 - > Stripping device for cross-sections 0.2 / 0.3 / 0.8 / 1.5 / 2.5 / 4 mm²
 - > Simplified insertion of single wires for stripping using location ridges
 - > With opening spring and locking device
 - > Easy insertion of coax and data cable thanks to opening aid
 - > Multi-component design with a soft plastic zone for comfortable use and a secure grip
 - > Housing made from stable glass fibre reinforced plastic

16 95 02 SB

- > For left-handers



16 95 01 SB



16 95 02 SB



Stripping of a coax cable



Stripping of a NYM cable



Stripping of a data cable



Stripping of a coax cable

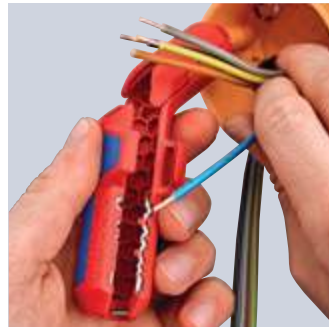

Wire stripping on single conductors



With concealed cutter in overhanging thumb rest on the side for convenient lengthwise cut

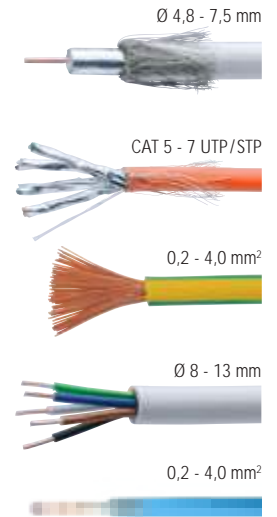

Article No.	EAN 4003773-	↔ mm		Stripping capacities				⚖ g
				round cable Ø mm	conductors and strands mm ²	data cable	coax cable Ø mm	
16 95 01 SB	079927	135	///	8 – 13	0.2 – 4	CAT 5 – 7, Twisted pair (UTP/STP)	4.8 – 7.5	75
16 95 02 SB	082910	135	///	8 – 13	0.2 – 4	CAT 5 – 7, Twisted pair (UTP/STP)	4.8 – 7.5	75

Gripping and Grip Pliers



Flat Nose Pliers	44
Round Nose Pliers	45
Long Reach Needle Nose Pliers	46
Long Reach Needle Nose Pliers with transverse profiles	46
Telephone Pliers	47
Gripping Pliers (Needle Nose Pliers)	47
Long Nose Pliers	48
Relay Adjusting Pliers	49
Duckbill Pliers	49
Gripping Pliers for precision mechanics	50
Mechanics' Pliers	51
Universal Grip Pliers	52
Welding Grip Pliers	52
Grip Pliers	53



Flat Nose Pliers

- > Flat, short, wide jaws
- > Knurled gripping surfaces
- > Special tool steel, forged, oil-hardened
- > DIN ISO 5745

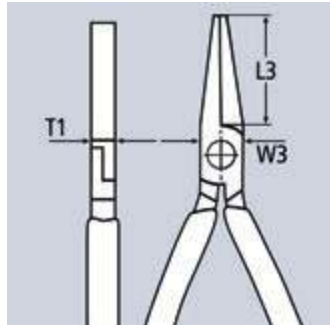

20 01 160



20 02 160



20 06 160

Article No.	EAN	↔ mm		Pliers	Head	Handles	Dimensions			⚖ g
							L3 mm	W3 mm	T1 mm	
20 01 125	4003773-033875	125					27.0	14.5	8.0	80
20 01 140	022794	140					28.0	15.5	9.5	105
20 01 160	033882	160		black atramentized	polished	plastic coated	30.0	17.0	9.5	140
20 01 180	042440	180					35.0	19.0	10.0	185
20 02 140	043386	140		black atramentized	polished	with multi-component grips	28.0	15.5	9.5	137
20 02 160	035008	160		black atramentized	polished	with multi-component grips	30.0	17.0	9.5	172
20 05 140	042464	140		chrome plated	chrome plated	with multi-component grips	28.0	15.5	9.5	136
20 05 160	042457	160		chrome plated	chrome plated	with multi-component grips	30.0	17.0	9.5	176
20 06 160	033783	160	 	chrome plated	chrome plated	insulated with multi-component grips, VDE-tested	30.0	17.0	9.5	176

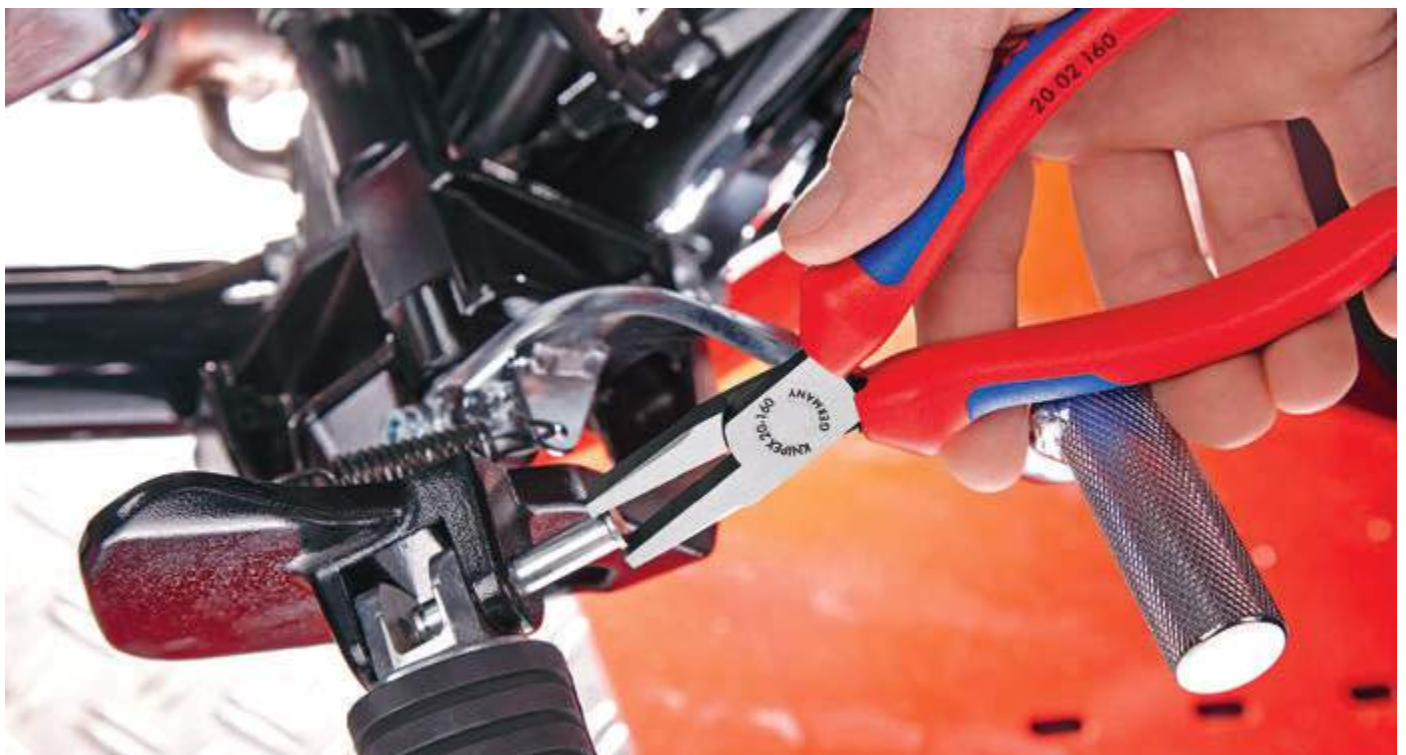

Round Nose Pliers

- > For bending wire loops
- > Round, short jaws; finely ground
- > Smooth tips
- > Special tool steel, forged, oil-hardened
- > DIN ISO 5745

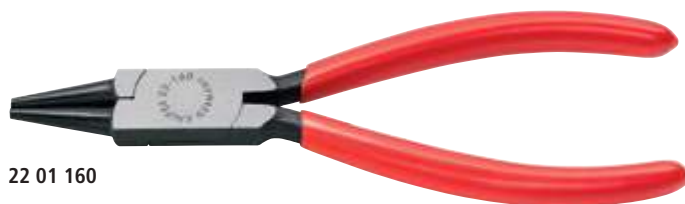
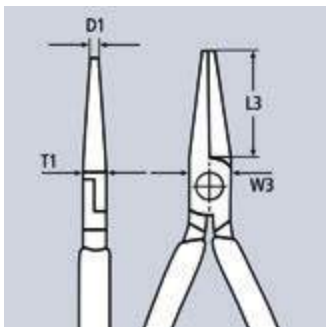

22 01 160



22 02 140



22 02 160



22 05 140



22 05 160



22 06 160

Article No.	EAN 4003773-	↔ mm		Pliers	Head	Handles	Dimensions				Δ g
							L3 mm	W3 mm	D1 mm	T1 mm	
22 01 125	033899	125		black atramentized	polished	plastic coated	27.0	14.5	2.0	8.0	75
22 01 140	022800	140	◁ 8	black atramentized	polished	plastic coated	28.0	16.5	2.5	9.5	100
22 01 160	033905	160	◁ 8	black atramentized	polished	plastic coated	30.0	18.0	3.0	9.5	135
22 02 140	043430	140	◁ 8	black atramentized	polished	with multi-component grips	28.0	16.5	2.5	9.5	129
22 02 160	023173	160	◁ 8	black atramentized	polished	with multi-component grips	30.0	18.0	3.0	9.5	170
22 05 140	042891	140	◁ 8	chrome plated	chrome plated	with multi-component grips	28.0	16.5	2.5	9.5	127
22 05 160	042907	160	◁ 8	chrome plated	chrome plated	with multi-component grips	30.0	18.0	3.0	9.5	169
22 06 160	033790	160	◁ 8 ⚡ 1000V ⚠ 8	chrome plated	chrome plated	insulated with multi-component grips, VDE-tested	30.0	18.0	3.0	9.5	175

Long Reach Needle Nose Pliers

- > Specially suitable for gripping and assembly work with a higher prehensile power
- > Knurled gripping surfaces
- > High-grade special tool steel, forged, oil-hardened

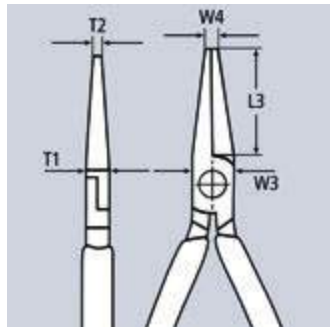

28 01 200



28 21 200

Article No.	EAN 4003773-	↔ mm	Pliers	Head	Handles	Dimensions					⚖ g	
						L3 mm	W3 mm	T1 mm	W4 mm	T2 mm		
28 01 200	044468	200		black atramentized	polished	plastic coated	33.0	13.5	10.5	4.0	10.5	197
28 21 200	028246	200		black atramentized	polished	plastic coated	34.0	13.5	10.5	3.0	3.0	187

Long Reach Needle Nose Pliers

with transverse profiles

Long Reach Needle Nose Pliers with wave profile

- ▶ For gripping, adjustment and assembly work in hard to reach areas thanks to slim, very long design
- ▶ Deep down situated parts can be easily reached using the slim, half-round tips

- > Careful yet reliable gripping, holding and guiding of small copper pipes, screws and cables as well as other round parts thanks to milled grooves with smooth surfaces
- > Serrated pipe grip to grip round parts
- > Particularly suitable for work in the automotive trade and in mechanical engineering
- > Slim yet robust tool
- > Forged from special tool steel, oil-hardened and tempered
- > DIN ISO 5745



28 71 280



28 81 280



Wave-shaped gripping profile: transverse profile for gripping, holding and guiding

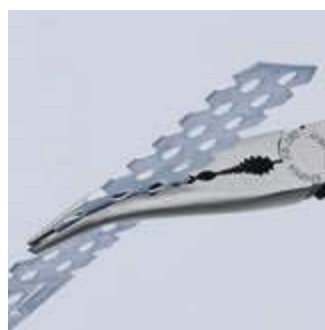
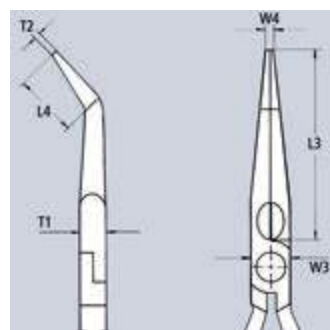
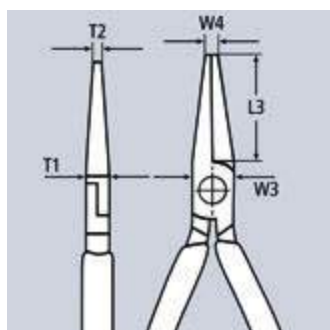

Article No.	EAN 4003773-	↔ mm	Pliers	Head	Handles	Dimensions					⚖ g	
						L3 mm	L4 mm	W3 mm	T1 mm	W4 mm		T2 mm
28 71 280	079415	280		polished	plastic coated	76.5		20.0	9.0	3.0	2.5	235
28 81 280	079422	280	$\times 45^\circ$	polished	plastic coated	70.0	20.0	20.0	9.0	2.5	2.5	235

Telephone Pliers

- > Gripping surfaces cross-hatched, knurled
- > Chrome vanadium electric steel, forged, oil-hardened
- > DIN ISO 5745

29 21 160 / 29 25 160

- > Extra slim, fine tips; also suitable for soldering work

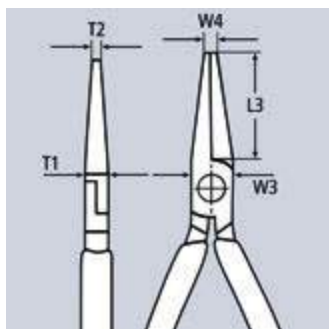

29 11 160



29 21 160

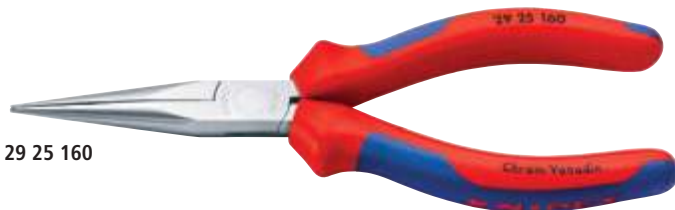

29 25 160

Article No.	EAN	↔ mm		Pliers	Head	Handles	Dimensions					Δ g
							L3 mm	W3 mm	T1 mm	W4 mm	T2 mm	
29 11 160	016175	160		black atramentized	polished	plastic coated	55.0	14.0	8.0	2.5	8.5	103
29 21 160	043454	160		black atramentized	polished	plastic coated	54.0	14.0	9.0	2.0	2.0	112
29 25 160	043478	160		chrome plated	chrome plated	with multi-component grips	54.0	14.0	9.0	2.0	2.0	139

Gripping Pliers

Needle-Nose Pliers

- > Precision pliers for very exact assembly, bending and adjusting work
- > With extra long jaws: length of jaws 55.0 mm
- > Smooth ground gripping surfaces
- > Edges carefully deburred
- > Chrome vanadium electric steel, forged, oil-hardened

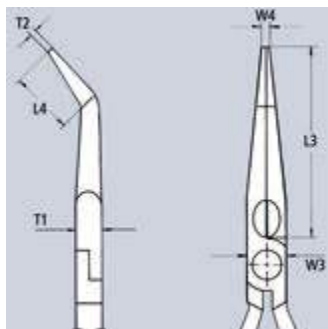
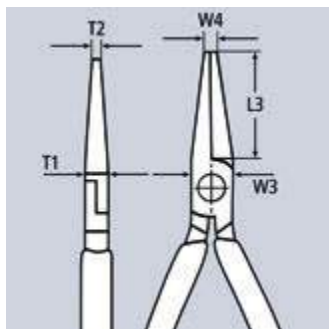

31 11 160



31 15 160



31 25 160

Article No.	EAN	↔ mm		Pliers	Head	Handles	Dimensions					Δ g	
							L3 mm	L4 mm	W3 mm	T1 mm	W4 mm		T2 mm
31 11 160	044475	160		black atramentized	polished	plastic coated	55.0		16.0	7.5	1.8	2.5	100
31 15 160	016465	160		chrome plated	chrome plated	with multi-component grips	55.0		16.0	7.5	1.8	2.5	124
31 21 160	046790	160		black atramentized	polished	plastic coated	55.0	27.0	16.0	7.5	1.8	2.5	97
31 25 160	016489	160		chrome plated	chrome plated	with multi-component grips	55.0	27.0	16.0	7.5	1.8	2.5	123

Long Nose Pliers

- > Heavy duty and wear resisting
- > Different jaw styles
- > Chrome vanadium electric steel, forged, oil-hardened
- > DIN ISO 5745

Style 1

- > Long, trapezoidal jaws; knurled gripping surfaces

Style 2

- > Long, half-round jaws; knurled gripping surfaces

Style 3

- > Long, round jaws; smooth gripping surfaces

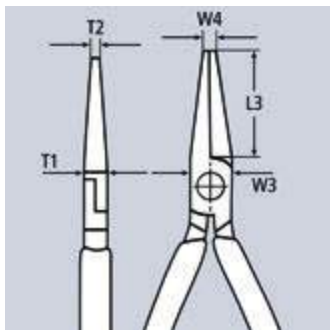

30 11 160

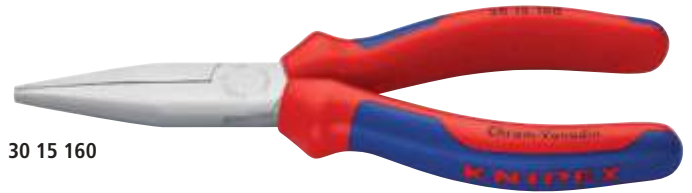

30 15 160



30 16 160



30 25 160



30 31 160

Article No.	EAN 4003773-	↔ mm	Style	Pliers	Head	Handles	Dimensions					⚖ g
							L3 mm	W3 mm	T1 mm	W4 mm	T2 mm	
30 11 140	033936	140	1				42.0	15.0	8.0	2.5	4.0	86
30 11 160	023128	160	1	black atramentized	polished	plastic coated	46.5	16.5	9.5	3.0	5.0	121
30 11 190	043492	190	1				50.0	18.5	8.0	3.0	8.0	140
30 13 140	016298	140	1	chrome plated	chrome plated	plastic coated	42.0	15.0	8.0	2.5	4.0	87
30 13 160	043485	160	1				46.5	16.5	9.5	3.0	5.0	118
30 15 140	042914	140	1				42.0	15.0	8.0	2.5	4.0	106
30 15 160	035046	160	1	chrome plated	chrome plated	with multi-component grips	46.5	16.5	9.5	3.0	5.0	149
30 15 190	001881	190	1				50.0	18.5	8.0	3.0	8.0	171
30 16 160	001904	160	1	chrome plated	chrome plated	insulated with multi-component grips, VDE-tested	46.5	16.5	9.5	3.0	5.0	150
30 21 140	042433	140	2				42.0	15.0	8.0	2.5	2.0	95
30 21 160	035053	160	2	black atramentized	polished	plastic coated	50.0	16.5	9.5	3.0	2.5	121
30 21 190	043508	190	2				50.0	18.5	8.0	3.0	2.4	135
30 23 140	016373	140	2	chrome plated	chrome plated	plastic coated	42.0	15.0	8.0	2.5	2.0	95
30 25 140	001980	140	2				42.0	15.0	8.0	2.5	2.0	114
30 25 160	035060	160	2	chrome plated	chrome plated	with multi-component grips	50.0	16.5	9.5	3.0	2.5	151
30 25 190	043515	190	2				50.0	18.5	8.0	3.0	2.4	168
30 31 160	035077	160	3	black atramentized	polished	plastic coated	41.0	16.5	9.5	5.0	2.5	110
30 33 160	043539	160	3	chrome plated	chrome plated	plastic coated	41.0	16.5	9.5	5.0	2.5	111
30 35 140	043102	140	3	chrome plated	chrome plated	with multi-component grips	37.5	15.0	8.0	4.0	2.0	102
30 35 160	035084	160	3				41.0	16.5	9.5	5.0	2.5	138
30 36 160	002123	160	3	chrome plated	chrome plated	insulated with multi-component grips, VDE-tested	41.0	16.5	9.5	5.0	2.5	141

Relay Adjusting Pliers

- > For gripping components and wires of the smallest diameters and for bending contact and relay springs
- > Polished gripping surfaces
- > Edges carefully deburred
- > High-grade special tool steel, forged, oil-hardened

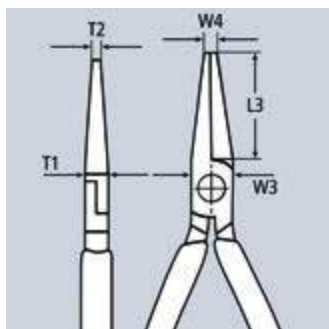

32 11 135



32 21 135



32 31 135

Article No.	EAN 4003773-	↔ mm		Pliers	Head	Handles	Dimensions					Δ g
							L3 mm	W3 mm	T1 mm	W4 mm	T2 mm	
32 11 135	035091	135		black atramentized	polished	plastic coated	34.0	12.5	7.0	1.0	1.5	73
32 21 135	043553	135		black atramentized	polished	plastic coated	34.0	12.5	7.0	1.0	3.5	74
32 31 135	043560	135		black atramentized	polished	plastic coated	32.0	12.5	7.0	1.0	3.5	73

Duckbill Pliers

- > Duckbill shaped jaws 9 mm wide at the tip and tapering to 1.5 mm thickness
- > Smooth gripping surfaces
- > Chrome vanadium electric steel, forged, oil-hardened

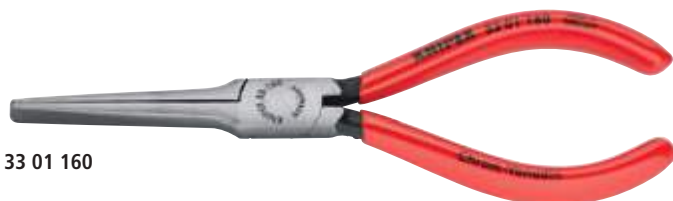
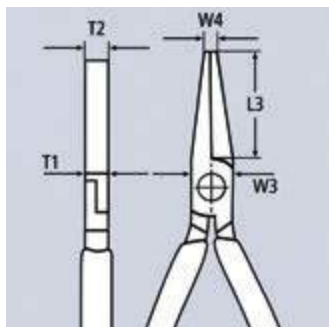

33 01 160

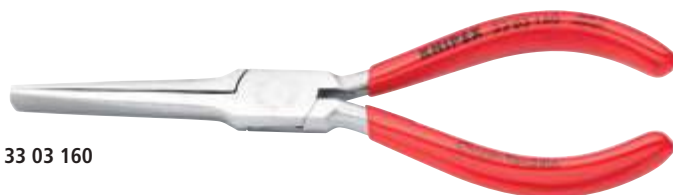

33 03 160

Article No.	EAN 4003773-	↔ mm		Pliers	Head	Handles	Dimensions					Δ g
							L3 mm	W3 mm	T1 mm	W4 mm	T2 mm	
33 01 160	016663	160		black atramentized	polished	plastic coated	55.0	15.0	7.5	3.0	9.0	103
33 03 160	016670	160		chrome plated	chrome plated	plastic coated	55.0	15.0	7.5	3.0	9.0	103

Gripping Pliers

for precision mechanics

- > Precision pliers for fine assembly work, e.g. in electronics and fine mechanics
- > For gripping, holding, bending and adjusting
- > Tips precision-ground
- > Smooth gripping surfaces
- > Edges carefully deburred
- > Lap joint
- > High-grade special tool steel, forged, oil-hardened
- > DIN ISO 9655

Style 1

- > Flat, wide jaws

Style 2

- > Flat, concave and pointed jaws

Style 3

- > Half-round jaws



37 11 125



37 13 125



37 21 125



37 23 125



37 31 125



37 33 125



37 41 125



37 43 125

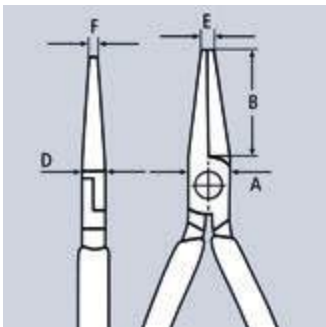

Article No.	EAN 4003773-	↔ mm		Style	Pliers	Head	Handles	Dimensions					⚖ g
								B mm	A mm	D mm	E mm	F mm	
37 11 125	014287	125		1	black afromentized	polished	plastic coated	27.0	12.5	7.0	2.0	5.5	76
37 13 125	043638	125		1	chrome plated	chrome plated	plastic coated	27.0	12.5	7.0	2.0	5.5	71
37 21 125	035138	125		2	black afromentized	polished	plastic coated	27.0	12.5	7.0	2.0	2.0	74
37 23 125	043645	125		2	chrome plated	chrome plated	plastic coated	27.0	12.5	7.0	2.0	2.0	72
37 31 125	035145	125		3	black afromentized	polished	plastic coated	27.0	12.5	7.0	2.0	1.6	74
37 33 125	016960	125		3	chrome plated	chrome plated	plastic coated	27.0	12.0	7.0	2.0	1.6	78
37 41 125	035152	125		4	black afromentized	polished	plastic coated	27.0	14.5	8.0	2.0	1.0	76
37 43 125	043652	125		4	chrome plated	chrome plated	plastic coated	27.0	14.5	8.0	2.0	1.0	76

Mechanics' Pliers

- > High bending strength of the pliers tips
- > Gripping surfaces cross-hatched, knurled
- > Vanadium electric steel; forged, oil-hardened
- > DIN ISO 5745

Style 2

- > 40° angled jaws

Style 3

- > Curved tip

38 35 200 T*

- > Pliers with tether attachment point for mounting a fall protection

38 71 200

- > 70° angled, half-round jaws, suitable for pulling split pins; for gripping at points that are difficult to access

38 91 200 / 38 95 200

- > 45° angled, half-round, long jaws, also suitable for gripping spark plugs and round components (spark plug cover "grabber")



38 11 200



38 15 200



38 21 200



38 25 200

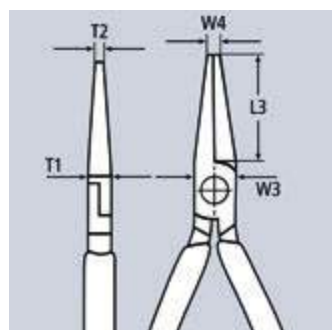

38 31 200



38 35 200



38 41 190



38 71 200

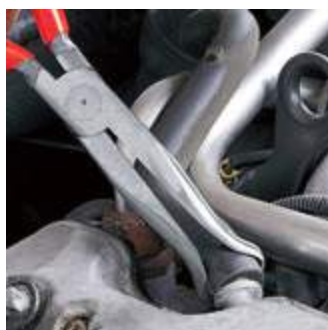

38 91 200



38 95 200

Article No.	EAN	↔ mm		Pliers	Head	Handles	Dimensions					Δ g
							L3 mm	W3 mm	T1 mm	W4 mm	T2 mm	
38 11 200	035169	200	⊗ ⊖	black atramentized	polished	plastic coated	73.0	17.5	9.5	3.0	2.5	179
38 15 200	039594	200	⊗ ⊖	chrome plated	chrome plated	with multi-component grips	73.0	17.5	9.5	3.0	2.5	209
38 21 200	035176	200	⊗ ⊖ ∠40°	black atramentized	polished	plastic coated	73.0	17.5	9.5	3.0	2.5	175
38 25 200	043669	200	⊗ ⊖ ∠40°	chrome plated	chrome plated	with multi-component grips	73.0	17.5	9.5	3.0	2.5	209
38 31 200	040712	200	⊗ ⊖	black atramentized	polished	plastic coated	73.0	17.5	9.5	3.0	2.5	176
38 35 200	017134	200	⊗ ⊖	chrome plated	chrome plated	with multi-component grips	73.0	17.5	9.5	3.0	2.5	205
38 35 200 T	083771	200	⊗ ⊖	chrome plated	chrome plated	with multi-component grips, with integrated tether attachment point for a tool tether	73.0	17.5	9.5	3.0	2.5	210
38 41 190	017141	190	⊗ ⊖ 	black atramentized	polished	plastic coated	50.0	18.0	8.0	4.0	8.0	139
38 45 190	043676	190	⊗ ⊖ 	chrome plated	chrome plated	with multi-component grips	50.0	18.0	8.0	4.0	8.0	171
38 71 200	017202	200	⊗ ⊖ ∠70°	black atramentized	polished	plastic coated	73.0	17.5	9.5	3.0	2.0	174
38 91 200	017219	200	⊗ ⊖ ∠45°	black atramentized	polished	plastic coated	73.0	17.5	9.5		2.5	177
38 95 200	017233	200	⊗ ⊖ ∠45°	chrome plated	chrome plated	with multi-component grips	73.0	17.5	9.5		2.5	207

*Other tools with tethering can be found from page 272

Universal Grip Pliers

- > Hold round, profile and flat material securely
- > Heavy duty model
- > With adjustment screw and release lever
- > One-hand operation
- > High clamping pressure due to toggle lever action
- > Pliers body: rolled steel, high-strength
- > Gripping jaws: chrome vanadium electric steel, forged

40 04 180

- > With one pivoting jaw



40 04 180



40 14 250

Article No.	EAN 4003773-	↔ mm		Pliers	○ mm	□ mm	⬡ mm	⚖ g
40 04 180	022190	180		galvanized	35	25	32	310
40 04 250	002710	250		galvanized	35	30	32	521
40 14 250	080329	250		galvanized	43	42	45	600

Welding Grip Pliers

- > For gripping, clamping and holding of diverse profiles
- > Heavy duty model
- > With adjustment screw and release lever
- > One-hand operation
- > High clamping pressure due to toggle lever action
- > Pliers body: rolled steel, high-strength

42 14 280

- > Heat resistant malleable cast iron jaws; section or flat material items lying side by side are held in place during welding; also for section material with vertical webs up to 15 mm height

42 24 280

- > Heat resistant malleable cast iron jaws; round or tubular material items lying centrally side by side are held securely during welding

42 34 280

- > Gripping jaws of chrome vanadium steel, drop forged; clamps cumbersome workpieces and sections with high webs up to 40 mm

42 44 280

- > With moveable jaws; gripping jaws of chrome vanadium steel, drop forged; clamps and balances bulky work components and profiles with high ridges of up to 40 mm



42 14 280



42 24 280



42 34 280



42 44 280



Article No.	EAN 4003773-	↔ mm	Pliers	○ mm	□ mm	⚖ g
42 14 280	022206	280	galvanized	30 – 65	50	917
42 24 280	022213	280	galvanized	10 – 70		850
42 34 280	022220	280	galvanized		90	692
42 44 280	080350	280	galvanized		90	740

Grip Pliers

- > Hold round, profile and flat material securely
- > Heavy duty model
- > With adjustment screw and release lever
- > One-hand operation
- > High clamping pressure due to toggle lever action
- > Pliers body: rolled steel, high-strength
- > Gripping jaws: chrome vanadium electric steel, forged

Style 0

- > Jaws for round workpieces, with wire cutter

Style 1

- > Jaws with double prism for round, section and flat material

Style 2

- > Straight jaws for flat material

Style 3

- > Long-Nose Grip Pliers, narrow, long jaws

Style 4

- > Long-Nose Grip Pliers, narrow, long jaws;
very suitable for areas that are difficult to reach;
non-serrated gripping area for pinching off hoses



41 04 250



41 14 250



41 24 225



41 34 165



41 44 200



Article No.	EAN 4003773-	↔ mm		Style	Pliers	○ mm	□ mm	⬡ mm	⚖ g
41 04 180	002741	180		0		30	20	30	363
41 04 250	002758	250	▨	0	galvanized	40	20	30	517
41 04 300	022183	300		0		65	30	34	923
41 14 250	023470	250	▨	1	galvanized	36	36	36	557
41 24 225	023487	225	▨	2	galvanized	25	16	30	504
41 34 165	047858	165	▨	3	galvanized	20	10	24	189
41 44 200	080343	200	▨ ∠70°	4	galvanized	20	20	30	400

Circlip Pliers



Circlip Pliers for internal circlips in bore holes	56
Circlip Pliers for external circlips on shafts	57
Precision Circlip Pliers for internal circlips in bore holes	58
– with overstretching limiter	59
Precision Circlip Pliers for external circlips on shafts	60
– with overstretching limiter	61
Circlip Pliers for large internal circlips up to 400 mm	62
Circlip Pliers for large external circlips up to 400 mm	62
Circlip Tool for circlips up to 1000 mm	63
Special Retaining Ring Pliers for retaining rings on shafts	64
Circlip Pliers for grip rings on shafts	64
Set of Circlip Pliers in roll-up bag	65
Pliers Sets in a foam tray	67
Precision Circlip Pliers Sets	68
Tool Box “SRZ”	69

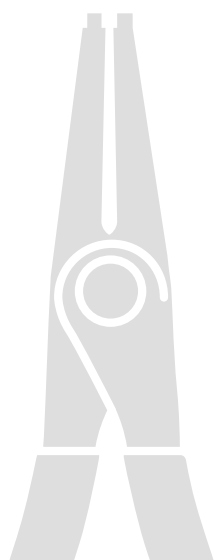

Circlip Pliers

for internal circlips in bore holes



- > Slim pattern, forged
- > Non-slip, solid tips
- > Pliers body and tips: chrome vanadium steel, forged, oil-hardened



44 11 J2



44 13 J2



44 21 J21



44 23 J21



44 31 J22

Style 1

> DIN 5256 C, straight tips

Style 2

> DIN 5256 D; 90° angled tips

Style 3

> 45° angled tips

Article No.	EAN	↔ mm		Style	Pliers	Head	Handles	Size of bore Ø mm	Tips Ø mm	Δ g
44 11 J0	040286	140	C	1	black atramentized	polished	plastic coated	8 – 13	0.9	88
44 11 J1	022862	140		1				12 – 25	1.3	88
44 11 J2	022879	180		1				19 – 60	1.8	135
44 11 J3	033943	225		1				40 – 100	2.3	196
44 11 J4	042549	320		1				85 – 140	3.2	469
44 13 J0	048176	140	C	1	chrome plated	chrome plated	plastic coated	8 – 13	0.9	89
44 13 J1	042938	140		1				12 – 25	1.3	88
44 13 J2	042945	180		1				19 – 60	1.8	138
44 13 J3	042952	225		1				40 – 100	2.3	194
44 13 J4	017301	320		1				85 – 140	3.2	463
44 21 J01	040132	130	Δ90° C	2	black atramentized	polished	plastic coated	8 – 13	0.9	88
44 21 J11	022886	130		2				12 – 25	1.3	88
44 21 J21	022893	170		2				19 – 60	1.8	139
44 21 J31	033769	215		2				40 – 100	2.3	196
44 21 J41	043683	300		2				85 – 140	3.2	462
44 23 J11	042969	130	Δ90° C	2	chrome plated	chrome plated	plastic coated	12 – 25	1.3	89
44 23 J21	042976	170		2				19 – 60	1.8	138
44 23 J31	042983	215		2				40 – 100	2.3	200
44 31 J02	066941	140	Δ45° C	3	black atramentized	polished	plastic coated	8 – 13	0.9	90
44 31 J12	066958	140		3				12 – 25	1.3	90
44 31 J22	066965	180		3				19 – 60	1.8	140
44 31 J32	066972	225		3				40 – 100	2.3	195
44 31 J42	066989	310		3				85 – 140	3.2	465

Circlip Pliers

for external circlips on shafts

- > Slim pattern, forged
- > Non-slip, solid tips
- > Pliers body and tips: chrome vanadium steel, forged, oil-hardened



46 13 A2



46 21 A21



46 31 A22

Style 1

- > DIN 5254 A; straight tips

Style 2

- > DIN 5254 B; 90° angled tips

Style 3

- > 45° angled tips

Article No.	EAN	↔ mm		Style	Pliers	Head	Handles	Size of shaft Ø mm	Tips Ø mm	Δ g
46 11 A0	033950	140	MM ○	1	black atramentized	polished	plastic coated	3 – 10	0.9	85
46 11 A1	022909	140		1				10 – 25	1.3	86
46 11 A2	022916	180		1				19 – 60	1.8	134
46 11 A3	033974	210		1				40 – 100	2.3	220
46 11 A4	042532	320		1				85 – 140	3.2	505
46 13 A0	017417	140	MM ○	1	chrome plated	chrome plated	plastic coated	3 – 10	0.9	85
46 13 A1	042990	140		1				10 – 25	1.3	82
46 13 A2	043003	180		1				19 – 60	1.8	133
46 13 A3	043010	210		1				40 – 100	2.3	211
46 21 A01	033967	125	90° MM ○	2	black atramentized	polished	plastic coated	3 – 10	0.9	85
46 21 A11	023005	125		2				10 – 25	1.3	85
46 21 A21	022923	170		2				19 – 60	1.8	132
46 21 A31	033981	200		2				40 – 100	2.3	219
46 21 A41	039365	300		2				85 – 140	3.2	510
46 23 A01	017509	125	90° MM ○	2	chrome plated	chrome plated	plastic coated	3 – 10	0.9	84
46 23 A11	043027	125		2				10 – 25	1.3	84
46 23 A21	043034	170		2				19 – 60	1.8	132
46 23 A31	043041	200		2				40 – 100	2.3	221
46 31 A02	066996	130	45° MM ○	3	black atramentized	polished	plastic coated	3 – 10	0.9	83
46 31 A12	067009	130		3				10 – 25	1.3	85
46 31 A22	067016	185		3				19 – 60	1.8	133
46 31 A32	067023	210		3				40 – 100	2.3	213
46 31 A42	067030	310		3				85 – 140	3.2	511

Precision Circlip Pliers

for internal circlips in bore holes



▶ Heavy duty in continuous operation: up to 10 times longer service life compared to turned tips

▶ With inserted tips for reliable work

> Bolted joint: precise, zero backlash operation of pliers

> Non-slip plastic coating on the handles

> Inserted tips: spring steel wire, drawn

> Pliers body: chrome vanadium electric steel, forged, oil-hardened



48 11 J2



48 21 J21

Style 1

> DIN 5256 C, straight tips

Style 2

> DIN 5256 D; 90° angled tips

High precision quality

Easy and reliable assembly: form-fitting inserted and pressed-in tips made of high-density spring steel offer a high level of protection against excessive stress and strain, e.g. when removing stuck rings. The large supporting surfaces and the position of the tips make it more difficult for the rings to bounce off.



KNIPEX circlip pliers with overexpansion guard

For the standardized fitting of circlips in the industrial serial production. Particularly manufacturers of sensitive, safety-relevant components (e.g. brakes or gears) highly appreciate the compliance of DIN 471 and 472. The mounting of circlip rings in this case requires pliers with overexpansion guard or a cone. KNIPEX Circlip Pliers with overexpansion guard meet the requirements and furthermore offer a superior durability.



Sturdy, inserted tips: made from high-density spring steel

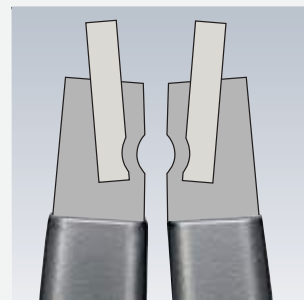

Tight fit through compression

Article No.	EAN 4003773-	↔ mm		Style	Pliers	Handles	Size of bore Ø mm	Tips Ø mm	⚖ g
48 11 J0	048510	140	⊙	1	grey atramentized	with non-slip plastic coating	8 – 13	0.9	105
48 11 J1	048527	140		1			12 – 25	1.3	105
48 11 J2	048534	180		1			19 – 60	1.8	175
48 11 J3	048541	225		1			40 – 100	2.3	266
48 11 J4	048558	320		1			85 – 140	3.2	580
48 21 J01	048619	130	⊙	2	grey atramentized	with non-slip plastic coating	8 – 13	0.9	105
48 21 J11	048633	130		2			12 – 25	1.3	105
48 21 J21	048640	165		2			19 – 60	1.8	175
48 21 J31	048657	210		2			40 – 100	2.3	265
48 21 J41	048664	305		2			85 – 140	3.2	576

- ▶ With overstretching limiter
- ▶ For all circlips with a diameter of 8 – 100 mm

- > With overstretching limiter for standardized assembly according to DIN 472
- > The adjustable stop screw prevents overexpansion
- > Adjustment using hexagonal screw
- > Ideal for series production as excessive expansion of rings is effectively prevented

Style 3

- > DIN 5256 C, straight tips

Style 4

- > DIN 5256 D; 90° angled tips



48 31 J3



48 41 J21

KNIPEX circlip pliers with overexpansion guard

For the standardized fitting of circlips in the industrial serial production. Particularly manufacturers of sensitive, safety-relevant components (e.g. brakes or gears) highly appreciate the compliance of DIN 471 and 472. The mounting of circlip rings in this case requires pliers with overexpansion guard or a cone. KNIPEX Circlip Pliers with overexpansion guard meet the requirements and furthermore offer a superior durability.



Article No.	EAN 4003773-	↔ mm		Style	Pliers	Handles	Size of bore Ø mm	Tips Ø mm	△ g
48 31 J0	079552	140	C	3	grey atramentized	with non-slip plastic coating	8 – 13	0.9	105
48 31 J1	073864	140		3			12 – 25	1.3	105
48 31 J2	073871	180		3			19 – 60	1.8	175
48 31 J3	073888	225		3			40 – 100	2.3	266
48 41 J01	079569	130	90° C	4	grey atramentized	with non-slip plastic coating	8 – 13	0.9	105
48 41 J11	079576	130		4			12 – 25	1.3	105
48 41 J21	080695	165		4			19 – 60	1.8	175
48 41 J31	079590	210		4			40 – 100	2.3	265

Precision Circlip Pliers

for external circlips on shafts



- ▶ Heavy duty in continuous operation: up to 10 times longer service life compared to turned tips
- ▶ With inserted tips for reliable work

- > Large contact faces on the tips: no distortion of circlips, easy fitting
- > Bolted joint: precise, zero backlash operation of pliers
- > Internal opening spring, protected and captive
- > Non-slip plastic coating on the handles
- > Precise, smoothly-operating screw joint
- > Slim head style allows use in confined areas
- > Handles with non-slip plastic coating
- > Inserted tips: spring steel wire, drawn
- > Pliers body: chrome vanadium electric steel, forged, oil-hardened

Style 1

> DIN 5254 A; straight tips

Style 2

> DIN 5254 B; 90° angled tips



49 11 A2



49 21 A21

High precision quality

Easy and reliable assembly: form-fitting inserted and pressed-in tips made of high-density spring steel offer a high level of protection against excessive stress and strain, e.g. when removing stuck rings. The large supporting surfaces and the position of the tips make it more difficult for the rings to bounce off.



Spring inside the joint: the spring is protected inside the precisely bolted joint. It does not hinder work and cannot get dirty or lost.



KNIPEX Precision Circlip Pliers: fit circlips without distortion: easy and quick assembling

KNIPEX circlip pliers with overexpansion guard

For the standardized fitting of circlips in the industrial serial production. Particularly manufacturers of sensitive, safety-relevant components (e.g. brakes or gears) highly appreciate the compliance of DIN 471 and 472. The mounting of circlip rings in this case requires pliers with overexpansion guard or a cone. KNIPEX Circlip Pliers with overexpansion guard meet the requirements and furthermore offer a superior durability.

Sturdy, inserted tips: made from high-density spring steel

Tight fit through compression

Article No.	EAN 4003773-	↔ mm		Style	Pliers	Handles	Size of shaft Ø mm	Tips Ø mm	⚖ g
49 11 A0	048718	140	MM ○	1	grey atramentized	with non-slip plastic coating	3 – 10	0.9	101
49 11 A1	048725	140		1			10 – 25	1.3	100
49 11 A2	048732	180		1			19 – 60	1.8	170
49 11 A3	048749	225		1			40 – 100	2.3	270
49 11 A4	048756	320		1			85 – 140	3.2	599
49 21 A01	048817	130	90° MM ○	2	grey atramentized	with non-slip plastic coating	3 – 10	0.9	100
49 21 A11	048824	130		2			10 – 25	1.3	102
49 21 A21	048831	165		2			19 – 60	1.8	169
49 21 A31	048848	210		2			40 – 100	2.3	272
49 21 A41	048855	305		2			85 – 140	3.2	601

- ▶ With overstretching limiter
- ▶ For all circlips with a diameter of 3 – 100 mm

- > With overstretching limiter for standardized assembly according to DIN 471
- > The adjustable stop screw prevents overexpansion
- > Adjustment using hexagonal screw
- > Ideal for series production as excessive expansion of rings is effectively prevented

Style 3

- > DIN 5254 A; straight tips, with overstretching limiter for standardized assembly according to DIN 471: the adjustable stop screw prevents overexpansion

Style 4

- > 90° angled tips; with overstretching limiter for standardized assembly in accordance with DIN 471; the adjustable stop screw prevents the rings from overstretching



49 31 A0



49 41 A01

KNIPLEX circlip pliers with overexpansion guard

For the standardized fitting of circlips in the industrial serial production. Particularly manufacturers of sensitive, safety-relevant components (e.g. brakes or gears) highly appreciate the compliance of DIN 471 and 472. The mounting of circlip rings in this case requires pliers with overexpansion guard or a cone. KNIPLEX Circlip Pliers with overexpansion guard meet the requirements and furthermore offer a superior durability.



Article No.	EAN 4003773-	↔ mm		Style	Pliers	Handles	Size of shaft Ø mm	Tips Ø mm	⚖ g
49 31 A0	061748	140	MM ∅	3	grey atramentized	with non-slip plastic coating	3 – 10	0.9	103
49 31 A1	073895	140		3			10 – 25	1.3	100
49 31 A2	073901	180		3			19 – 60	1.8	170
49 31 A3	073918	225		3			40 – 100	2.3	270
49 41 A01	061755	130	∠90° MM ∅	4	grey atramentized	with non-slip plastic coating	3 – 10	0.9	102
49 41 A11	079606	130		4			10 – 25	1.3	102
49 41 A21	079613	165		4			19 – 60	1.8	169
49 41 A31	079620	210		4			40 – 100	2.3	272

Circlip Pliers

for large internal circlips

- > With locking device, can be released
- > With replaceable tips made of tempered steel
- > Black powder-coated
- > Pliers body: rolled steel, high-strength
- > Tips: special tool steel, oil-hardened

Style 1

- > DIN 5256 C, straight tips

Style 2

- > DIN 5256 D; 90° angled tips



44 10 J5



44 20 J61

Article No.	EAN 4003773-	↔ mm		Style	Pliers	Size of bore Ø mm	Tips Ø mm	⚖ g
44 10 J5	024910	570	○	1	black powder-coated	122 – 300	3.5	1738
44 10 J6	024927	580		1		252 – 400	4.5	1755
44 20 J51	024958	590	∠90° ○	2	black powder-coated	122 – 300	3.5	1803
44 20 J61	024965	600		2		252 – 400	4.5	1723
44 19 J5	024934	1 pair of spare tips for 44 10 J5						
44 19 J6	024941	1 pair of spare tips for 44 10 J6						
44 29 J51	024972	1 pair of spare tips for 44 20 J51						
44 29 J61	024989	1 pair of spare tips for 44 20 J61						

Circlip Pliers

for large external circlips

- > With locking device, can be released
- > With replaceable tips made of tempered steel
- > Black powder-coated
- > Pliers body: rolled steel, high-strength
- > Tips: special tool steel, oil-hardened

Style 1

- > DIN 5254 A; straight tips

Style 2

- > DIN 5254 B; 90° angled tips



46 10 A5



46 20 A51

Article No.	EAN 4003773-	↔ mm		Style	Pliers	Size of shaft Ø mm	Tips Ø mm	⚖ g
46 10 A5	024996	560	○	1	black powder-coated	122 – 300	3.5	1773
46 10 A6	025009	570		1		252 – 400	4.5	1795
46 20 A51	025023	570	∠90° ○	2	black powder-coated	122 – 300	3.5	1832
46 20 A61	025030	580		2		252 – 400	4.5	1826
46 19 A5	024316	1 pair of spare tips for 46 10 A5						
46 19 A6	025016	1 pair of spare tips for 46 10 A6						
46 29 A51	025047	1 pair of spare tips for 46 20 A51						
46 29 A61	025054	1 pair of spare tips for 46 20 A61						

Circlip Tool

for internal and external circlips up to 1,000 mm nominal size

- > Universally usable for large circlips with diameters of 400 – 1000 mm
- > Reliable opening and closing of the circlips and holding by self-locking precision spindle drive
- > For fitting and removing circlips
- > Circlips are reliably caught thanks to short, direct attachment
- > Replaceable tips having working ends with diameters of 6 and 9 mm, for perfect adaption to the handling bores in the circlips
- > Optional operation by hand, with Allen key, ratchet wrench or cordless screwdriver
- > Areas of application are heavy engines where very high forces and torques are transmitted with large shafts and bearings , e.g. wind turbines, tidal power stations, generator construction, hydropower stations, large machine construction (rolling mills, presses), shipbuilding, aerospace
- > Tool in a plastic case with foam insert
- > Tip material: chrome-vanadium electric steel

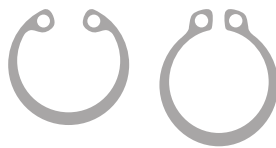

Manually operable



Automated or manual operation



Replaceable inserts for internal and external circlips



Article No.	EAN 4003773-		Size of bore Ø mm	Size of shaft Ø mm	⚖ g
46 10 100	075417	⊙ ⊚	400 – 1000	400 – 1000	2200
46 19 100 01	084549	Spare tips 6 mm			
46 19 100 02	084556	Spare tips 9 mm			

Special Retaining Ring Pliers



for retaining rings on shafts

- > For fitting horseshoe-shaped spring retaining rings and circlips without grip holes
- > For shaft retaining devices
- > With opening spring
- > Chrome vanadium electric steel, forged, oil-hardened

45 10 170

- > For retaining rings with a minimum ring split gap of 3.6 mm

45 21 200

- > Angled jaws with centering hole; for snap rings larger than 12.0 mm dia., e.g. for securing cardan shafts in a motor vehicle; minimum ring split gap of the rings 2.2 mm



45 10 170



45 21 200



45 10 170



45 21 200



45 21 200

Article No.	EAN 4003773-	↔ mm		Pliers	Handles	Δ g
45 10 170	017370	170	MM ○	burnished		156
45 21 200	031208	200	30° MM ○	burnished	plastic coated	186

Circlip Pliers

for grip rings on shafts



- > For fitting grip rings on shafts from 1.5 – 30 mm dia.
- > With opening spring
- > Solid style, forged
- > Non-slip, solid tips
- > Pliers body and tips: chrome vanadium steel, forged, oil-hardened

46 11 G0

- > For rings of 1.5 - 4.0 mm dia., with adjustable stop screw to prevent overstretching



46 11 G0



46 11 G1

Article No.	EAN 4003773-	↔ mm		Pliers	Head	Handles	Size of shaft Ø mm	Tips Ø mm	Δ g
46 11 G0	047896	140	MM	black atramentized	polished	plastic coated	1.5 – 4.0	0,9	87
46 11 G1	031062	140	MM	black atramentized	polished	plastic coated	4.0 – 7.0	1,3	85
46 11 G2	031079	140					5.0 – 13.0	1,3	85
46 11 G3	031086	140					14.0 – 18.0	1,3	86
46 11 G4	031093	180					20.0 – 30.0	1,8	134

Set of Circlip Pliers

Compactly packed: four-piece circlip plier sets in practical roll-up bag

- > Tool roll made of hard-wearing polyester fabric
- > With practical, adjustable quick release fastener
- > Dimensions, open (L x H): 315 x 275 mm



00 19 56



00 19 57

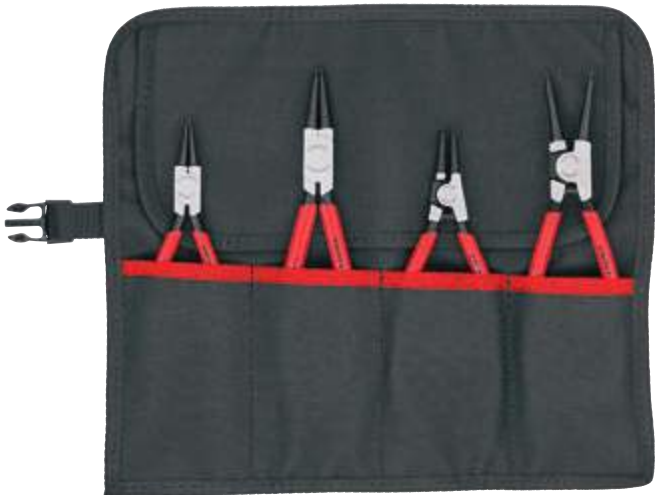

00 19 56 V01



00 19 57 V01

Article No.	EAN			Style	Capacity Ø mm	Tips Ø mm	Number	g	
00 19 56	4003773-030973		Circlip Pliers Set, 4 parts					670	
		⊙	44 11 J2	Circlip Pliers for internal circlips in bore holes	straight tips	19 – 60	1.8	1	
		⊙ ∠90°	44 21 J21		angled tips	19 – 60	1.8	1	
		⊙ / / /	46 11 A2	Circlip Pliers for external circlips on shafts	straight tips	19 – 60	1.8	1	
		⊙ ∠90° / / /	46 21 A21		angled tips	19 – 60	1.8	1	
00 19 56 V01	081548		Circlip Pliers Set, 4 parts					615	
		⊙	44 11 J1	Circlip Pliers for internal circlips in bore holes	straight tips	12 – 25	1.3	1	
		⊙	44 11 J2			19 – 60	1.8	1	
		⊙ / / /	46 11 A1	Circlip Pliers for external circlips on shafts		10 – 25	1.3	1	
		⊙ / / /	46 11 A2			19 – 60	1.8	1	
00 19 57	050056		Precision Circlip Pliers Set, 4 parts					665	
		⊙	48 11 J1	Precision Circlip Pliers for internal circlips in bore holes	straight tips	12 – 25	1.3	1	
		⊙	48 11 J2			19 – 60	1.8	1	
		⊙ / / /	49 11 A1	Precision Circlip Pliers for external circlips on shafts		10 – 25	1.3	1	
		⊙ / / /	49 11 A2			19 – 60	1.8	1	
00 19 57 V01	081555		Precision Circlip Pliers Set, 4 parts					871	
		⊙	48 11 J2	Precision Circlip Pliers for internal circlips in bore holes	straight tips	19 – 60	1.3	1	
		⊙ ∠90°	48 21 J21		bent tips	19 – 60	1.8	1	
		⊙ / / /	49 11 A2	Precision Circlip Pliers for external circlips on shafts	straight tips	19 – 60	1.3	1	
		⊙ ∠90° / / /	49 21 A21		bent tips	19 – 60	1.8	1	
00 19 56 LE	035954		Tool Roll, empty, 4 compartments						171

Set of Circlip Pliers

Handy storage: eight-piece range in space-saving roll-up bag

- > Tool roll made of hard-wearing polyester fabric
- > With practical, adjustable quick release fastener
- > Dimensions, open (L x H): 610 x 240 mm

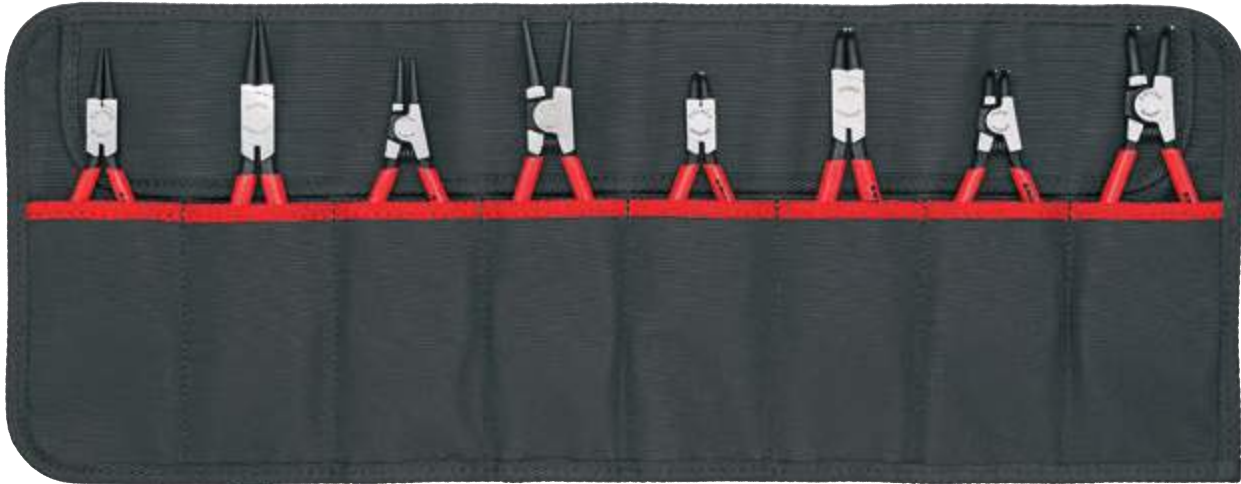

00 19 58 V01



00 19 58 V02

Article No.	EAN		Style	Capacity Ø mm	Tips Ø mm	Number	g	
00 19 58 V01	4003773-081562		Circlip Pliers Set, 8 parts				1156	
		⊙	44 11 J1	Circlip Pliers for internal circlips in bore holes	straight tips	12 – 25	1.3	1
		⊙	44 11 J2			19 – 60	1.8	1
		⊙ ∠90°	44 21 J11	Circlip Pliers for internal circlips in bore holes	angled tips	12 – 25	1.3	1
		⊙ ∠90°	44 21 J21			19 – 60	1.8	1
		⊙ M	46 11 A1	Circlip Pliers for external circlips on shafts	straight tips	10 – 25	1.3	1
		⊙ M	46 11 A2			19 – 60	1.8	1
		⊙ ∠90° M	46 21 A11		angled tips	10 – 25	1.3	1
		⊙ ∠90° M	46 21 A21			19 – 60	1.8	1
00 19 58 V02	081579		Precision Circlip Pliers Set, 8 parts				1357	
		⊙	48 11 J1	Precision Circlip Pliers for internal circlips in bore holes	straight tips	12 – 25	1.3	1
		⊙	48 11 J2			19 – 60	1.8	1
		⊙ ∠90°	48 21 J11	Precision Circlip Pliers for internal circlips in bore holes	angled tips	12 – 25	1.3	1
		⊙ ∠90°	48 21 J21			19 – 60	1.8	1
		⊙ M	49 11 A1	Precision Circlip Pliers for external circlips on shafts	straight tips	10 – 25	1.3	1
		⊙ M	49 11 A2			19 – 60	1.8	1
		⊙ ∠90° M	49 21 A11		angled tips	10 – 25	1.3	1
		⊙ ∠90° M	49 21 A21			19 – 60	1.8	1
00 19 58 LE	081920		Tool Roll, empty, 8 compartments				281	

Pliers Sets

Ideally stored and versatile: pliers sets in matching foam insert for workbench and workshop trolley

- > In a foam tray for workbenches and tool trolleys
- > Clearly organised storage of tools
- > Precisely-sized recesses for holding the pliers
- > Foam tray dimensions (W x H x D): 335 x 165 x 33 mm
- > Material: two colour, closed pore foam



00 20 01 V02 Pliers Set "SRZ"

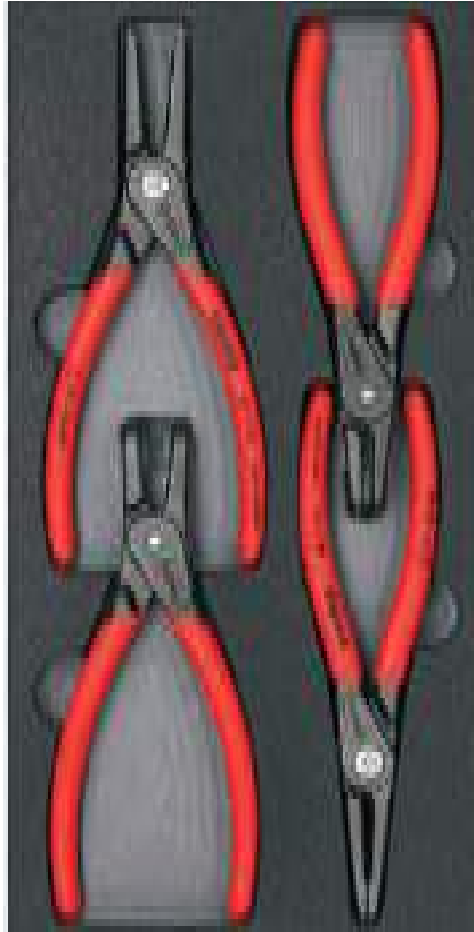

00 20 01 V09 Pliers Set "SRZ II"

Article No.	EAN				Number	g
00 20 01 V02	4003773-069652			Pliers Set "SRZ", six precision circlip pliers in a foam tray		915
		⊙	48 11 J1	Precision Circlip Pliers for internal circlips in bore holes	1	
		⊙	48 11 J2		1	
		⊙ $\angle 90^\circ$	48 21 J21		1	
		⊙ $\overline{\text{MM}}$	49 11 A1	Precision Circlip Pliers for external circlips on shafts	1	
		⊙ $\overline{\text{MM}}$	49 11 A2		1	
		⊙ $\overline{\text{MM}} \angle 90^\circ$	49 21 A21		1	
00 20 01 V09	073291			Pliers Set "SRZ II", four precision circlip pliers in a foam tray		820
		⊙	48 11 J2	Precision Circlip Pliers for internal circlips in bore holes	1	
		⊙ $\angle 90^\circ$	48 21 J21		1	
		⊙ $\overline{\text{MM}}$	49 11 A2	Precision Circlip Pliers for external circlips on shafts	1	
		⊙ $\overline{\text{MM}} \angle 90^\circ$	49 21 A21		1	

Precision Circlip Pliers Set

- > Attractive sales packaging with Euro standard perforation
- > Contains common Precision Circlip Pliers for highest requirements
- > Sturdy plastic packaging, also suitable for storage of the pliers



00 20 03 SB

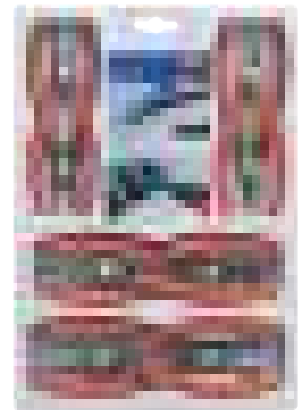

00 20 04 SB

Article No.	EAN 4003773-			Style	Capacity Ø mm	Tips Ø mm	Quantity	g
00 20 03 SB	050100		Precision Circlip Pliers Set, 4 parts					685
		⊙	48 11 J1	straight tips	12 – 25	1.3	1	
			48 11 J2		19 – 60	1.8	1	
		⊙	49 11 A1		10 – 25	1.3	1	
			49 11 A2		19 – 60	1.8	1	
00 20 04 SB	062417		Precision Circlip Pliers Set, 8 parts					
		⊙	48 11 J1	straight tips	12 – 25	1.3	1	
			48 11 J2		19 – 60	1.8	1	
		⊙	49 11 A1		10 – 25	1.3	1	
			49 11 A2		19 – 60	1.8	1	
		⊙	48 21 J11	angled tips	12 – 25	1.3	1	
			48 21 J21		19 – 60	1.8	1	
		⊙	49 21 A11		12 – 25	1.3	1	
			49 21 A21		19 – 60	1.8	1	

Set of Circlip Pliers

- > Attractive sales packaging with Euro standard perforation
- > Contains common Circlip Pliers for internal and external circlips
- > Sturdy plastic packaging, also suitable for storage of the pliers



00 20 03 V02

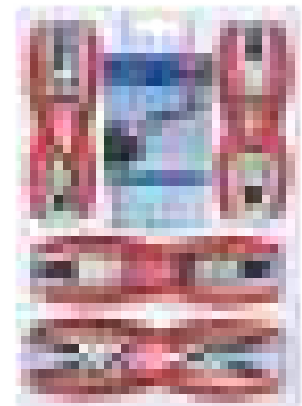

00 20 04 V01

Article No.	EAN 4003773-			Style	Capacity Ø mm	Tips Ø mm	Quantity	g
00 20 03 V02	077640		Set of Circlip Pliers, 4 parts					450
		⊙	44 11 J1	straight tips	12 – 25	1.3	1	
			44 11 J2		19 – 60	1.8	1	
		⊙	46 11 A1		10 – 25	1.3	1	
			46 11 A2		19 – 60	1.8	1	
00 20 04 V01	077633		Set of Circlip Pliers, 8 parts					890
		⊙	44 11 J1	straight tips	12 – 25	1.3	1	
			44 11 J2		19 – 60	1.8	1	
		⊙	46 11 A1		10 – 25	1.3	1	
			46 11 A2		19 – 60	1.8	1	
		⊙	44 21 J11	angled tips	12 – 25	1.3	1	
			44 21 J21		19 – 60	1.8	1	
		⊙	46 21 A11		10 – 25	1.3	1	
			46 21 A21		19 – 60	1.8	1	

Tool Box "SRZ" Precision Circlip Pliers

Well fixed, safely transported:
Extensive range in handy case

- > High-quality, impact-resistant plastic case
- > Contains common Precision Circlip Pliers for highest requirements
- > Precisely-sized recesses for holding the pliers
- > Clearly organised storage of tools
- > Dimensions, exterior (W x H x D): 260 x 80 x 210 mm



Article No.	EAN			Style	Capacity Ø mm	Tips Ø mm	Number	△ g
00 21 25	4003773-050131		Tool Box "SRZ", Precision Circlip Pliers, 8 parts					1635
		○	48 11 J1 48 11 J2	straight tips	12 – 25	1.3	1	
			Precision Circlip Pliers for internal circlips in bore holes		19 – 60	1.8	1	
		○ MM	49 11 A1 49 11 A2		10 – 25	1.3	1	
			Precision Circlip Pliers for external circlips on shafts		19 – 60	1.8	1	
		○ ∠90°	48 21 J11 48 21 J21	angled tips	12 – 25	1.3	1	
			Precision Circlip Pliers for external circlips on shafts		19 – 60	1.8	1	
		○ MM ∠90°	49 21 A11 49 21 A21		10 – 25	1.3	1	
			Precision Circlip Pliers for external circlips on shafts		19 – 60	1.8	1	





Carpenters' Pincers and
Concreters' Nippers

KNIPLEX POWER CUT
GERMANY
977 300
977 44

Carpenters' Pincers	72
Hammerhead Style Carpenters' Pincers	72
Farriers' Pincers (Tear-off Pliers for vehicle bodywork)	73
Potters' Pincers (Brick Pincers)	73
End Cutting Nippers	73
Concreters' Nippers (Tower Pincers, Steel Fixers' Nippers)	74
High Leverage Concreters' Nippers	75

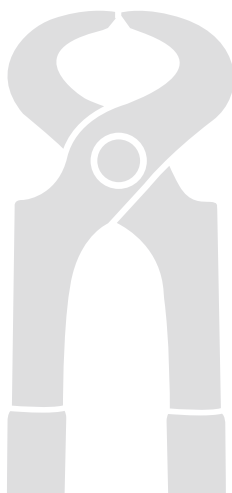

Carpenters' Pincers

- > For heavy duty
- > Specially favoured by craftsmen for their precise workmanship
- > Extreme wear resistance and well balanced
- > Cutting edge hardness approx. 60 HRC
- > Special tool steel, forged, oil-hardened
- > DIN ISO 9243

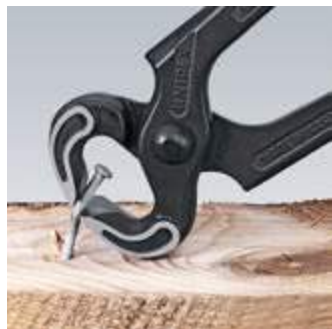

50 00 160



50 00 210



50 00 160

Article No.	EAN 4003773-	↔ mm		Pliers	Head	Handles	Cutting capacities	
							● Ø mm	⚖ g
50 00 160	023111	160					1.8	225
50 00 180	021940	180					2.0	320
50 00 210	021957	210	✔	black atramentized	polished		2.2	425
50 00 225	021964	225					2.2	440
50 00 250	022930	250					2.2	570
50 00 300	039662	300					2.4	862
50 01 160	035275	160					1.8	235
50 01 180	035282	180					2.0	330
50 01 210	035299	210	✔	black atramentized	polished	plastic coated	2.2	445
50 01 225	035305	225					2.2	465
50 01 250	035312	250					2.2	595
50 01 300	016915	300					2.4	903

Hammerhead Style Carpenters' Pincers

- > With striking face to hammer down nails
- > Cutting edge hardness approx. 60 HRC
- > Special tool steel, forged, oil-hardened
- > DIN ISO 9243



51 01 210



Multi-functional: driving in and pulling nails

Article No.	EAN 4003773-	↔ mm		Pliers	Head	Handles	Cutting capacities	
							● Ø mm	⚖ g
51 01 210	023104	210	✔	black atramentized	polished	plastic coated	2.2	413

Farriers' Pincers

Tear-off Pliers for vehicle bodywork

- > The ideal pliers for the farrier
- > With small head and anvil for redirecting horseshoe-nails
- > Also suitable for dismantling work in vehicle body workshops
- > Cutting edges additionally hardened; cutting edge hardness approx. 59 HRC
- > Special tool steel, forged, multi stage oil-hardened



55 00 300

Article No.	EAN	↔ mm		Pliers	Head	Head width mm	⚖ g
55 00 300	4003773-039402	300		black atramentized	polished	20	780



Potters' Pincers

Brick Pincers

- > For pottery work
- > With wire cutter for soft wire
- > Cutting edges additionally hardened; cutting edge hardness approx. 59 HRC
- > Special tool steel, forged, multi stage oil-hardened



58 30 225

Article No.	EAN	↔ mm		Pliers	Head	Head width mm	⚖ g
58 30 225	4003773-014331	225		black atramentized	polished	20	347

End Cutting Nippers

- ▶ The head shape provides optimised movement when tightening steel mesh knots during reinforced concrete work

- > With cutting edges for soft and hard wire
- > Also suitable for twisting and cutting binding wire
- > Cutting edges additionally hardened; cutting edge hardness approx. 61 HRC
- > High-grade special tool steel, forged, multi stage oil-hardened



68 01 280



Article No.	EAN	↔ mm		Pliers	Head	Handles	Cutting capacities			⚖ g
							☐ mm	◐ mm	◑ mm	
68 01 160	4003773-013792	160		black atramentized	polished	plastic coated	4.0	2.8	2.3	202
68 01 180	4003773-013808	180					4.0	3.2	2.5	284
68 01 200	4003773-013815	200					4.0	3.5	2.8	319
68 01 280	4003773-077664	280					4.5	4.0	3.2	465

Concreters' Nippers

Tower Pincers, Steel Fixers' Nippers

- > To twist and cut wire in one operation: fast, reliable and economical
- > Cutting edges additionally hardened; cutting edge hardness approx. 61 HRC
- > High-grade special tool steel, forged, multi stage oil-hardened
- > DIN ISO 9242

99 00 220 K12

- > With 12 mm head, particularly suitable for tile paving work



99 00 280



99 00 220 K12



99 01 220



99 04 280



Article No.	EAN 4003773-	↔ mm	Pliers	Head	Handles	Cutting capacities			
						Ø mm	Ø mm	Δ g	
99 00 200	014393	200	✂	black atramentized	polished	1.8	1.4	230	
99 00 220	013273	220				2.4	1.6	315	
99 00 250	013280	250				2.4	1.6	405	
99 00 280	014096	280				2.8	1.8	455	
99 00 300	014409	300				3.1	1.8	510	
99 00 220 K12	027812	220	✂	black atramentized	polished	2.4	1.6	315	
99 01 200	021452	200	✂	black atramentized	polished	plastic coated	1.8	1.4	247
99 01 220	021469	220					2.4	1.6	334
99 01 250	021483	250					2.4	1.6	429
99 01 280	021490	280					2.8	1.8	480
99 01 300	014416	300					3.1	1.8	548
99 04 220	048398	220	✂	bright zinc plated		2.4	1.6	315	
99 04 250	048213	250				2.4	1.6	405	
99 04 280	048220	280				2.8	1.8	455	

High Leverage Concreters' Nippers

high lever transmission

- ▶ 25% less effort required compared to conventional concreters' nippers of the same size
- ▶ Extra-slim form for tying deep mounted steel rods
- > To lace concrete reinforcing steel with binding wire from a roll
- > Wire is twisted and cut in a single pass
- > High-leverage joint, minimising strain, even when thick binding wires are used
- > The high damping of the cutting stroke on cutting through the binding wire reduces the strain on tendons and muscles
- > Cutting edges additionally hardened; cutting edge hardness approx. 61 HRC
- > High-grade special tool steel, forged, multi stage oil-hardened
- > DIN ISO 9242



99 10 250



99 10 300



99 11 250



99 14 250



Article No.	EAN 4003773-	↔ mm		Pliers	Head	Handles	Cutting capacities		Head width Ø mm	Δ g
							● Ø mm	● Ø mm		
99 10 250	071396	250	▶	black atramentized	polished		3.3	1.8	25	350
99 10 300	022398	300	▶	black atramentized	polished		3.8	2.0	25	501
99 11 250	071402	250	▶	black atramentized	polished	plastic coated	3.3	1.8	25	350
99 11 300	042365	300	▶	black atramentized	polished	plastic coated	3.8	2.0	25	537
99 14 250	071419	250	▶	bright zinc plated			3.3	1.8	25	350
99 14 300	028116	300	▶	bright zinc plated			3.8	2.0	25	505

Cutting Pliers



Diagonal Cutters for plastics	78
High Leverage Flush Cutter	79
Diagonal Cutter for fibre optics	79
Diagonal Cutters	82
Diagonal Cutters for electromechanics	84
KNIPEX X-Cut® – Compact Diagonal Cutters	85
High Leverage Diagonal Cutters	86
KNIPEX TwinForce – High Performance Diagonal Cutters	88
High Leverage Centre Cutters	89
KNIPEX CoBolt S – Compact Bolt Cutters	91
KNIPEX CoBolt – Compact Bolt Cutters	92
KNIPEX CoBolt XL – Compact Bolt Cutters	94
Bolt Cutters	95
Concrete Mesh Cutter	96
Bolt End Cutting Nippers	97
High Leverage End Cutting Nippers	98
End Cutting Nippers	98



Diagonal Cutters for plastics

- > Cutting face flush
- > For nearly flush cutting of moulded plastic components from sprues
- > Cuts soft materials such as lead in a flush cut
- > With opening spring
- > Vanadium electric steel; forged, oil-hardened



72 01 160



72 02 125



72 11 160



72 21 160

Article No.	EAN	↔ mm		Head	Handles	Δ g	
72 01 140	043713	140				120	
72 01 160	041245	160	▲ MM	polished	plastic coated	164	
72 01 180	046837	180				193	
72 02 125	044215	125	▲ MM	polished	with multi-component grips	109	
72 11 160	046813	160	▲ 45° MM	polished	plastic coated	156	
72 21 160	046820	160	▲ 85° MM	polished	plastic coated	165	
72 09 01	053415	Pressure spring for 72 01					

High Leverage Flush Cutter

for soft metal and plastic

- > For the flush cutting of soft materials, e.g. plastic, aluminium, copper, lead
- > Permits the energy-saving cutting of thick work components made of soft metal and plastic
- > 20° angled head with single-sided joint bar and diagonal cutting edge for flush cutting; with space for gripping
- > Opening spring and locking device are integrated in the handles also for comfortable work and protected transport
- > Precision cutting edges for soft material
- > Cutting edges additionally hardened; cutting edge hardness approx. 59 HRC
- > Chrome vanadium electric steel, forged, multi stage oil-hardened



Clean, flush cutting of copper conductor rails



Ideal for the flush cutting plastic sprues with large diameters



72 62 200



Article No.	EAN 4003773- 081913	↔ mm 200	▶▶	Pliers	Handles	Cutting capacities		⚖ g 375
						MM	black atramentized	
72 62 200	081913	200	▶▶	black atramentized	with slim multi-component grips		6.0	375

Diagonal Cutter for fibre optics

- > Specially developed for cutting fibre optics (glass fibre cables)
- > Cutting face flush
- > Cutting edges additionally induction-hardened, cutting edge hardness approx. 63 HRC
- > With opening spring
- > Vanadium electric steel, forged, multi stage oil-hardened



72 51 160



Article No.	EAN 4003773- 028031	↔ mm 160	▶▶	Head	Handles	⚖ g 166
72 51 160	028031	160	▶▶	polished	plastic coated	166

KNIPEX WORLD OF DIAGONAL CUTTERS

With four tailor-made diagonal cutters, KNIPEX provides solutions for every application. An extraordinary variety ensures an excellent response from the "KNIPEX World of diagonal cutters" to whatsoever specification.

KNIPEX-Diagonal Cutter

The classic model. The indispensable cutting tool for versatile use.

KNIPEX-High Leverage Diagonal Cutter

The robust. For very tough, continuous use.

KNIPEX X-Cut

The all-rounder. Compact and light. Powerful and precise.

KNIPEX TwinForce

The superior model. For comfortable cutting, repetitive cutting or extremely hard cutting jobs.

KNIPEX TwinForce



The reapplying cutter

Double-hinged design

Hand force is multiplied by 39

Diagonal Cutter



Long cutting edges for cutting cable; also precise enough for the finest stranded wires
Hand force is multiplied by 12

High Leverage Diagonal Cutter



Forged on hinged joint for robust use
Hand force is multiplied by 13

KNIPEX X-Cut



Box joint:
greatest stability with little weight
Hand force is multiplied by 16

1

16 KG

with reapplication



2

36 KG



3

30 KG



4

40 KG



Required hand force for a nail with Ø 3 mm



KNIPEX TwinForce

High Leverage Diagonal Cutter

KNIPEX X-Cut®

Diagonal Cutter



Diagonal Cutters

- > The indispensable diagonal cutter for all-round use
- > High-quality material and precise workmanship for long service life
- > Precision cutting edges for soft and hard wire
- > Clean cutting of thin copper wires, also at the cutting edge tips
- > Cutting edges additionally induction-hardened, cutting edge hardness approx. 62 HRC
- > Narrow head style for use in confined areas
- > Vanadium electric steel, forged, multi stage oil-hardened
- > DIN ISO 5749

70 05 160 T / 70 05 180 T / 70 06 160 T / 70 06 180 T*

- > Pliers with tether attachment point for mounting a fall protection



70 01 160

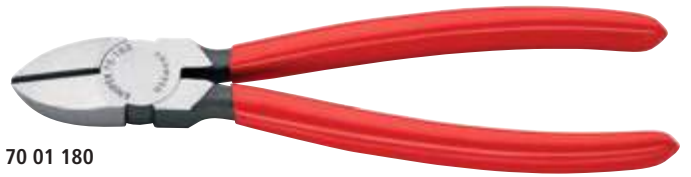

70 01 180

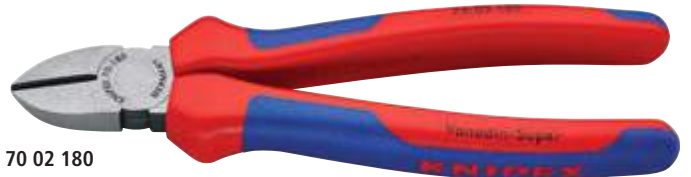

70 02 180



70 05 180



70 05 180 T



70 06 180



70 07 180



70 15 110



Clean cutting of thin copper wires, also at the cutting edge tips

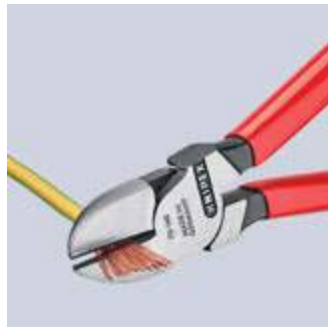



Article No.	EAN 4003773-	↔ mm		Pliers	Head	Handles	Cutting capacities			
							☉ Ø mm	◐ Ø mm	◑ Ø mm	⚖ g
70 01 110	014324	110					3.0	2.0	1.2	80
70 01 125	013402	125	✂	black atramentized	polished	plastic coated	3.0	2.3	1.5	80
70 01 140	013419	140	✂				4.0	2.5	1.8	126
70 01 180	018070	180					4.0	3.0	2.5	200
70 01 160	013426	160	✂	black atramentized	polished	plastic coated	4.0	3.0	2.0	171
70 02 125	034025	125					3.0	2.3	1.5	119
70 02 140	023098	140	✂	black atramentized	polished	with multi-component grips	4.0	2.5	1.8	150
70 02 180	034049	180					4.0	3.0	2.5	252
70 02 160	034032	160	✂	black atramentized	polished	with multi-component grips	4.0	3.0	2.0	206
70 05 125	039501	125					3.0	2.3	1.5	119
70 05 140	039488	140	✂	chrome plated	chrome plated	with multi-component grips	4.0	2.5	1.8	154
70 05 180	043706	180					4.0	3.0	2.5	246
70 05 160	039600	160	✂	chrome plated	chrome plated	with multi-component grips	4.0	3.0	2.0	207
70 05 180 T	080039	180	✂	chrome plated	chrome plated	with multi-component grips and integrated tether attachment point	4.0	3.0	2.5	258
70 05 160 T	080022	160	✂	chrome plated	chrome plated	with multi-component grips and integrated tether attachment point	4.0	3.0	2.0	210
70 06 125	018124	125					3.0	2.3	1.5	121
70 06 140	040293	140	✂ ⚡ 1000 V	chrome plated	chrome plated	insulated with multi-component grips, VDE-tested	4.0	2.5	1.8	160
70 06 180	033813	180					4.0	3.0	2.5	254
70 06 180 T	081470	180	✂ ⚡ 1000 V	chrome plated	chrome plated	insulated with multi-component grips with integrated insulated tether attachment point, VDE tested	4.0	3.0	2.5	270
70 06 160	021995	160	✂ ⚡ 1000 V	chrome plated	chrome plated	insulated with multi-component grips, VDE-tested	4.0	3.0	2.0	216
70 06 160 T	081463	160	✂ ⚡ 1000 V	chrome plated	chrome plated	insulated with multi-component grips with integrated insulated tether attachment point, VDE tested	4.0	3.0	2.0	230
70 07 180	018179	180	✂ ⚡ 1000 V	chrome plated	chrome plated	with dipped insulation, VDE-tested	4.0	3.0	2.5	269
70 07 160	018155	160	✂ ⚡ 1000 V	chrome plated	chrome plated	with dipped insulation, VDE-tested	4.0	3.0	2.0	227
70 11 110	018193	110	✂ M	black atramentized	polished	plastic coated	3.0	2.0	1.2	91
70 15 110	029649	110	✂ M	chrome plated	chrome plated	with multi-component grips	3.0	2.0	1.2	98
70 26 160	018223	160	✂ ⚡ 1000 V	chrome plated	chrome plated	insulated with multi-component grips, VDE-tested	4.0			216

Diagonal Cutter

for electromechanics

- > With sharp, precisely aligned cutting edges
- > Cutting edges additionally induction-hardened, cutting edge hardness approx. 63 HRC
- > Lap joint
- > Vanadium electric steel, forged, multi stage oil-hardened
- > DIN ISO 5749

76 12 125

- > Low-friction double spring for gentle and even opening

76 22 125

- > Low-friction double spring for gentle and even opening; without bevel for flush cutting of soft wires

76 81 125

- > Particularly tapered head with small bevel for work in confined areas (cable harnesses, multiple stranded wires)



76 01 125



76 03 125



76 05 125



76 12 125



76 81 125

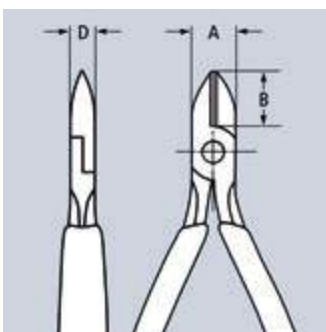

Article No.	EAN	↔ mm	Icon	Pliers	Head	Handles	Cutting capacities				Dimensions			g
							Ø mm	Ø mm	Ø mm	Ø mm	A mm	B mm	D mm	
76 01 125	044482	125		black atramentized	polished	plastic coated	0.4 - 3.0	2.3	1.5	0.6	14.5	16.0	9.0	85
76 03 125	048923	125		chrome plated	chrome plated	plastic coated	0.4 - 3.0	2.3	1.5	0.6	14.5	16.0	9.0	85
76 05 125	005315	125		chrome plated	chrome plated	with multi-component grips	0.4 - 3.0	2.3	1.5	0.6	14.5	16.0	9.0	118
76 12 125	048015	125		black atramentized	polished	with multi-component grips	0.4 - 3.0	2.3	1.5	0.6	14.5	16.0	9.0	112
76 22 125	048022	125		black atramentized	polished	with multi-component grips	0.4 - 2.5				14.5	16.0	9.0	107
76 81 125	040644	125		black atramentized	polished	plastic coated	0.4 - 1.7	1.3	0.8		14.5	16.0	9.0	85

KNIPEX X-Cut

PATENTED

Compact Diagonal Cutters high lever transmission

- ▶ Cuts finest strands as well as multi-core cables and piano wires
- ▶ Powerful, light and universal
- > High cutting performance with minimum effort due to optimum co-ordination of the cutting edge angle and transmission ratio
- > Box-joint design: highest stability with low weight
- > Doubly supported joint axis for heavy duty
- > Large opening width for thicker cables
- > Cuts precisely, even through fine copper wires
- > Compact, low-weight construction
- > Universally usable, in the assembly, maintenance and production
- > Chrome vanadium heavy-duty steel, forged, multi stage oil-hardened
- > Precision cutting edges additionally induction-hardened, cutting edge hardness approx. 62 HRC
- > DIN ISO 5749

73 05 160 T / 73 06 160 T*

- > Pliers with tether attachment point for mounting a fall protection



73 02 160



73 05 160



73 05 160 T



73 06 160

40 % less effort

required compared to diagonal cutters of the same length.
With double mounted hinged joint.

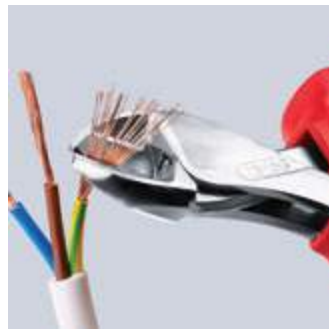

Box-joint design: highest stability with low weight

Article No.	EAN 4003773-	↔ mm		Pliers	Head	Handles	Cutting capacities					△ g
							⊙ mm	◐ mm	◑ mm	● mm	⊕ mm	
73 02 160	075127	160		black atramentized	polished	with multi-component grips	4.8	3.8	2.7	2.2	12.0	175
73 05 160	075134	160		chrome plated	chrome plated	with multi-component grips	4.8	3.8	2.7	2.2	12.0	175
73 05 160 T	080077	160		chrome plated	chrome plated	with multi-component grips and integrated tether attachment point	4.8	3.8	2.7	2.2	12.0	180
73 06 160	075141	160		chrome plated	chrome plated	insulated with multi-component grips, VDE-tested	4.8	3.8	2.7	2.2	12.0	175
73 06 160 T	081487	160		chrome plated	chrome plated	insulated with multi-component grips with integrated insulated tether attachment point, VDE tested	4.8	3.8	2.7	2.2	12.0	185

*Other tools with tethering can be found from page 272

High Leverage Diagonal Cutters

- > For very tough, continuous use
- > High cutting performance with minimum effort due to optimum co-ordination of the cutting edge angle and transmission ratio
- > Precision cutting edges additionally induction-hardened (cutting edge hardness approx. 64 HRC), for all sorts of wire including piano wire
- > Chrome vanadium heavy-duty steel, forged, multi stage oil-hardened
- > DIN ISO 5749

Style 1

- > With opening spring; to be activated if required

Style 2

- > 12° angled head offers clearance for gripping

Length 250 mm

- > The 250-mm-long diagonal cutter is suitable for copper conductors up to 16 mm² and aluminium conductors up to 35 mm²

74 02 200 / 74 02 250 / 74 06 250 T / 74 22 200 / 74 22 250 T*

- > Pliers with tether attachment point for mounting a fall protection



74 01 200



74 02 180



74 02 200 T



74 05 180



74 06 200



74 06 200 T



74 07 200



74 12 180

20% less effort

required compared to high-leverage diagonal cutters of the same length. With integrated forged joint axle.



74 12: just gentle sliding with your thumb will activate the opening spring



74 12: opening spring in deactivated position





With integrated forged axle for heavy duty

Article No.	EAN 4003773-	↔ mm		Style	Pliers	Head	Handles	Cutting capacities			
								Ø mm	Ø mm	Ø mm	Δ g
74 01 140	039747	140		0				3.1	2.0	1.5	131
74 01 160	033141	160		0				3.4	2.5	2.0	178
74 01 180	022008	180	✂	0	black atramentized	polished	plastic coated	3.8	2.7	2.2	241
74 01 200	034056	200		0				4.2	3.0	2.5	263
74 01 250	034063	250		0				4.6	3.5	3.0	391
74 02 140	042419	140		0				3.1	2.0	1.5	157
74 02 160	023081	160		0				3.4	2.5	2.0	209
74 02 180	023074	180	✂	0	black atramentized	polished	with multi-component grips	3.8	2.7	2.2	273
74 02 200	040309	200		0				4.2	3.0	2.5	304
74 02 250	042402	250		0				4.6	3.5	3.0	437
74 02 200 T	080084	200	✂	0	black atramentized	polished	with multi-component grips and integrated tether attachment point	4.2	3.0	2.5	305
74 02 250 T	080091	250		0				4.6	3.5	3.0	460
74 05 140	039617	140		0				3.1	2.0	1.5	157
74 05 160	022961	160		0				3.4	2.5	2.0	209
74 05 180	022978	180	✂	0	chrome plated	chrome plated	with multi-component grips	3.8	2.7	2.2	270
74 05 200	035367	200		0				4.2	3.0	2.5	303
74 05 250	039754	250		0				4.6	3.5	3.0	440
74 06 160	040705	160		0				3.4	2.5	2.0	215
74 06 180	022985	180	✂ ⚡ 1000 V	0	chrome plated	chrome plated	insulated with multi-component grips, VDE-tested	3.8	2.7	2.2	280
74 06 200	033820	200	⚡ 1000 V	0				4.2	3.0	2.5	304
74 06 250	041955	250		0				4.6	3.5	3.0	453
74 06 200 T	081494	200	✂ ⚡ 1000 V	0	chrome plated	chrome plated	insulated with multi-component grips with integrated insulated tether attachment point, VDE tested	4.2	3.0	2.5	305
74 06 250 T	081500	250	⚡ 1000 V	0				4.6	3.5	3.0	465
74 07 200	018414	200	✂ ⚡ 1000 V	0	chrome plated	chrome plated	with dipped insulation, VDE-tested	4.2	3.0	2.5	328
74 07 250	018421	250	⚡ 1000 V	0				4.6	3.5	3.0	510
74 12 160	065111	160	✂ MM	1	black atramentized	polished	with multi-component grips	3.4	2.5	2.0	209
74 12 180	060192	180		1				3.8	2.7	2.2	273
74 21 200	050483	200	✂ ∠12°	2	black atramentized	polished	plastic coated	4.2	3.0	2.5	258
74 21 250	045021	250		2				4.6	3.5	3.0	390
74 22 200	051831	200	✂ ∠12°	2	black atramentized	polished	with multi-component grips	4.2	3.0	2.5	300
74 22 250	071372	250		2				4.6	3.5	3.0	437
74 22 200 T	080107	200	✂ ∠12°	2	black atramentized	polished	with multi-component grips and integrated tether attachment point	4.2	3.0	2.5	305
74 22 250 T	080114	250		2				4.6	3.5	3.0	460

KNIPEX TwinForce

High Performance Diagonal Cutters

▶ The superior High-Leverage Diagonal Cutter with patented double joint

- > Ideal transmission of force due to double-hinged design
- > Reliably cuts all types of wire, including steel tape
- > For rough or very fine cutting
- > Low cutting impact: gentle on hands. The tension on muscles and tendons is relieved
- > For comfortable cutting, repetitive cutting or extremely hard cutting jobs
- > High degree of stability and zero-backlash due to precisely milled forged-in axles
- > Chrome vanadium heavy-duty steel, forged, multi stage oil-hardened
- > Precision cutting edges additionally induction-hardened, cutting edge hardness approx. 63 – 64,5 HRC
- > DIN ISO 5749

73 72 180 F

> With opening spring to simplify reapplication and for repetitive cutting



73 71 180



73 72 180



73 72 180 F



The high performance diagonal cutters with opening spring for easier reapplication and for heavy use



The opening spring can be easily activated and deactivated by a press of the thumb

Cuts again 50% easier than the tried and tested KNIPEX high leverage diagonal cutters

The option to reapply the tool. The KNIPEX TwinForce cuts even 4 mm thick wire without great effort when reapplied two or three times.

Conventional high leverage diagonal cutters either cannot cut these diameters or only with very great effort.

KNIPEX TwinForce Reapplying

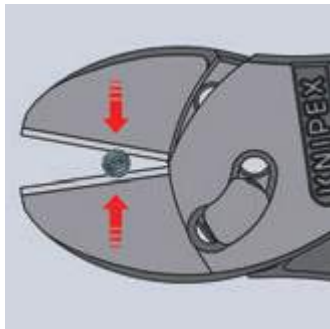

Insert the wires as close to the hinge as possible. In case of cutters with very high transmission, the width of the gap between the cutting edges close to the fulcrum may be less than the thickness of the wire. Wires may slip forward when the cutting starts.

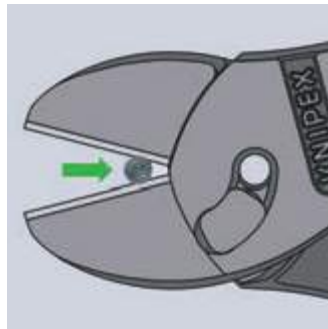

First make a notch in the wire using the KNIPEX TwinForce until the required hand force increases considerably. Now open the pliers and slide the wire backwards towards the joint. Hold the cutting edge in the notches you have made in step 1.

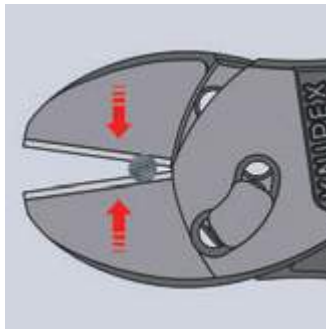

Continue cutting in the same location along the wire. Now cutting is much more easier because the wire remains in place closer to the fulcrum.

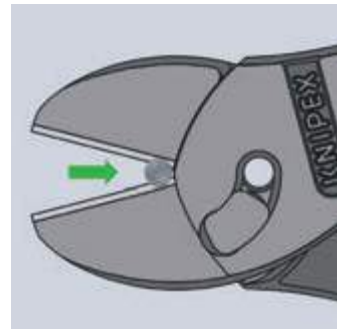

You can repeat this process if necessary.

Article No.	EAN 4003773-	↔ mm	Pliers	Head	Handles	Cutting capacities				g
						⊙ Ø mm	◐ Ø mm	◑ Ø mm	● Ø mm	
73 71 180	074762	180	black atramentized	polished	plastic coated	5.5	4.6	3.2	3.0	255
73 72 180	074779	180	black atramentized	polished	with multi-component grips	5.5	4.6	3.2	3.0	280
73 72 180 F	077657	180	black atramentized	polished	with multi-component grips	5.5	4.6	3.2	3.0	280



High Leverage Centre Cutters

- > With integrated forged axle for heavy duty
- > With precision cutting edges for soft, hard and piano wire
- > Cuts thick wires with less effort than other diagonal cutters of the same length
- > Centric precision cutting edges
- > High cutting performance with minimum effort due to optimum co-ordination of the cutting edge angle and transmission ratio
- > Cutting edges additionally induction-hardened, cutting edge hardness approx. 64 HRC
- > Chrome vanadium heavy-duty steel, forged, multi stage oil-hardened



74 91 250



The cutting edges are in the centre of the cutter head



Article No.	EAN	↔ mm	Pliers	Head	Handles	Cutting capacities				⚖ g
						Ø mm	Ø mm	Ø mm	Ø mm	
74 91 250	4003773-034070	250	black atramentized	polished	plastic coated	5.0	5.0	3.8	3.5	395

KNIPEX CoBolt S

Compact and powerful

In a handy length of 160 mm



KNIPEX CoBolt S

Compact Bolt Cutters

► Specially suitable for small hands

- > Precision cutting edges for soft and hard wire as well as piano wire
- > Cuts components such as bolts, nails, rivets etc. up to \varnothing 4.4 mm
- > Extremely high cutting capacity with little effort required due to extremely effective joint design
- > Cutting edges additionally induction-hardened, cutting edge hardness approx. 64 HRC
- > The microstructure on cutters keeps the material to be cut in a good insertion position: makes optimal use of the mechanics
- > With gripping surface below the joint for gripping and pulling wires from \varnothing 1.0 mm
- > Chrome vanadium heavy-duty steel, forged, multi stage oil-hardened



71 01 160



71 31 160



71 01 160



71 31 160



Powerful through to the tips



Slim head for ideal accessibility



Compact, light and always to hand

Article No.	EAN	↔ mm	Pliers	Handles	Cutting capacities				⚖ g	
					⊙ Ø mm	◐ Ø mm	◑ Ø mm	● Ø mm		
71 01 160	082668	160	✂	black atramentized	plastic coated	5.3	4.4	3.2	3.0	200
71 31 160	084587	160	✂	black atramentized	plastic coated	5.3	4.4	3.2	3.0	200

KNIPEX CoBolt

Compact Bolt Cutters

Clever muscle man

- > With precision cutting edges for soft, hard and piano wire
- > Cuts bolts, nails, rivets, etc. up to 5.2 mm dia.
- > Efficient joint design ensures exceptional cutting performance with little effort
- > Cutting edges additionally induction-hardened, cutting edge hardness approx. 64 HRC
- > Chrome vanadium heavy-duty steel, forged, multi stage oil-hardened
- > DIN ISO 5743

- ▶ Micro-structured cutting edge reduces slipping of the material from the jaws
- ▶ With gripping surface below the joint for gripping and pulling wires with a diameter as from 1 mm

71 12 200

opening spring and locking device are integrated in the handles also for comfortable work and protected transport

71 02 200 T*

Pliers with tether attachment point for mounting a fall protection



Micro-structured cutting edge allows easy cutting of large cross-sections



With gripping surface below the joint for gripping and pulling wires with a diameter as from 1 mm



Opening spring and locking device are integrated in the handles also for comfortable work and protected transport

CoBolt

60% less effort

required compared to conventional high-leverage diagonal cutters. The ingenious lever-action mechanism ensures an extremely favourable lever ratio with very little friction. The cutting force is about 30 times higher than the hand force applied.



71 01 200



71 02 200



71 02 200 T



71 12 200

Article No.	EAN	↔ mm	Pliers	Handles	Cutting capacities				⚖ g
					⊘ mm	⊘ mm	⊘ mm	⊘ mm	
71 01 200	033165	200	black atramentized	plastic coated	6.0	5.2	4.0	3.6	335
71 02 200	047056	200		with slim multi-component grips	6.0	5.2	4.0	3.6	372
71 02 200 T	080046	200	black atramentized	with multi-component grips and integrated tether attachment point	6.0	5.2	4.0	3.6	376
71 12 200	066859	200	black atramentized	with slim multi-component grips	6.0	5.2	4.0	3.6	375

- ▶ The recess in the blade allows easier cutting of thicker wires, e.g. for anchor bolts in false ceilings
- ▶ With gripping surface below the joint for gripping and pulling wires with a diameter as from 1 mm



71 31 200

71 32 200 / 71 32 200 T*

opening spring and locking device are integrated in the handles also for comfortable work and protected transport

71 32 200 T*

Pliers with tether attachment point for mounting a fall protection



71 31 200/71 32 200/71 32 200 T
The recess in the blade allows easier cutting of thicker wires, e.g. for anchor bolts in false ceilings



71 31 200/71 32 200/71 32 200 T
With gripping surface below the joint for gripping and pulling wires with a diameter as from 1 mm



Article No.	EAN 4003773-	↔ mm	Style	Pliers	Handles	Cutting capacities				⚖ g
						Ø mm	Ø mm	Ø mm	Ø mm	
71 31 200	042327	200	3	black atramentized	plastic coated	6.0	5.2	4.0	3.6	330
71 32 200	066880	200	3	black atramentized	with slim multi-component grips	6.0	5.2	4.0	3.6	370
71 32 200 T	080060	200			with multi-component grips and integrated tether attachment point	6.0	5.2	4.0	3.6	374

- ▶ 20° angled head with single-sided joint bar and diagonal cutting edge for flush cutting; with space for gripping

71 22 200 / 71 22 200 T*

opening spring and locking device are integrated in the handles also for comfortable work and protected transport

71 22 200 T*

Pliers with tether attachment point for mounting a fall protection

71 41 200

the recess in the blade allows easier cutting of thicker wires, e.g. for anchor bolts in false ceilings



71 21 200

(PATENTED)



71 22 200

Article No.	EAN 4003773-	↔ mm	Style	Pliers	Handles	Cutting capacities				⚖ g
						Ø mm	Ø mm	Ø mm	Ø mm	
71 21 200	066866	200	∠20°	black atramentized	plastic coated	6.0	5.2	4.0	3.6	320
71 22 200	066873	200	∠20°	black atramentized	with slim multi-component grips	6.0	5.2	4.0	3.6	375
71 22 200 T	080053	200			with multi-component grips and integrated tether attachment point	6.0	5.2	4.0	3.6	379
71 41 200	066897	200	∠20°	black atramentized	plastic coated	6.0	5.2	4.0	3.6	335

*Other tools with tethering can be found from page 272

KNIPEX CoBolt XL

Compact Bolt Cutters

The compact bolt cutters from KNIPEX with long handles for one and two-hand operation. Up to a 40-fold increase of manual force.

- ▶ For powerful cutting of larger cross-sections as well as very hard materials
- ▶ Two-hand operation for maximum cutting force
- > 60 % less effort required compared to conventional high-leverage diagonal cutters
- > 40-fold increase of manual force due to special joint design
- > With gripping surface below the joint for gripping and pulling wires from Ø 1.0 mm
- > Induction-hardened precision blades: cutting edge hardness approx. 64 HRC
- > Chrome vanadium heavy-duty steel, forged, multi stage oil-hardened

71 01 250

> Straight cutting edges

71 31 250

> Blades with recess for easier cutting of larger cross-sections thanks to better leverage close to the fulcrum



71 01 250



71 31 250



Two-hand operation for maximum cutting force

Article No.	EAN 4003773-	↔ mm	▶◀	Pliers	Handles	Cutting capacities			
						◐ Ø mm	◑ Ø mm	● Ø mm	⚖ g
71 01 250	079637	250	▶◀	black atramentized	plastic coated	5.6	4.0	3.8	465
71 31 250	079644	250	▶◀	black atramentized	plastic coated	6.0	4.3	4.2	475



Bolt Cutters

Cuts hard components up to 48 HRC

- > Cutting capacity up to 48 HRC hardness
- > Robust cutting edges are additionally induction-hardened, cutting edge hardness approx. 62 HRC
- > Forged-in stopper with comfortable shock-absorber
- > Good access due to very flat construction of head and joint area
- > Ergonomically angled handles to minimise effort
- > Sturdy non-slip two-colour dual component handle sleeves
- > Precise adjustment (12 positions) by eccentric bolt
- > High cutting performance with minimum effort due to optimum co-ordination of the cutting edge angle and transmission ratio
- > Bolted cutter head, replaceable
- > Joint: special tool steel, forged
- > Handles: steel tube, powder-coated
- > Blade: chrome vanadium heavy-duty steel, forged, multi stage oil-hardened



Forged-in stopper with damping inserts: cushions the cutting stroke comfortably



Article No.	EAN 4003773-	↔ mm	Head	Handles	Cutting capacities			⚖ g
					HRC 19 Ø mm	HRC 40 Ø mm	HRC 48 Ø mm	
71 72 460	066750	460	▶◀ grey atramentized	with multi-component grips	8.0	6.0	5.0	2100
71 72 610	066767	610			9.0	8.0	7.0	2550
71 72 760	066774	760			11.0	9.0	8.0	4250
71 72 910	066781	910			13.0	10.0	9.0	4950
71 79 460	066804	Spare cutter head for 71 72 460 complete with screws						
71 79 610	066811	Spare cutter head for 71 72 610 complete with screws						
71 79 760	066828	Spare cutter head for 71 72 760 complete with screws						
71 79 910	066835	Spare cutter head for 71 72 910 complete with screws						

Concrete Mesh Cutter

- > Cutting capacity up to 48 HRC hardness
- > Robust cutting edges are additionally induction-hardened, cutting edge hardness approx. 62 HRC
- > Forged-in stopper with comfortable shock-absorber
- > Good access due to very flat construction of head and joint area
- > Ergonomically angled handles to minimise effort
- > Sturdy non-slip two-colour dual component handle sleeves
- > Precise adjustment (12 positions) by eccentric bolt
- > High cutting performance with minimum effort due to optimum co-ordination of the cutting edge angle and transmission ratio
- > Bolted cutter head, replaceable
- > Joint: special tool steel, forged
- > Handles: steel tube, powder-coated
- > Blade: chrome vanadium heavy-duty steel, forged, multi stage oil-hardened



The special shape of the mesh cutter head, 71 82 950, enables it to cut structural steel that is lying down flat



71 82 950



Article No.	EAN 4003773- 066798	↔ mm 950	▶◀ grey atramentized	Head	Handles	Cutting capacities			⚖ g 4110
						HRC 19 Ø mm 11.0	HRC 40 Ø mm 9.0	HRC 48 Ø mm 6.0	
71 82 950					with multi-component grips				
71 89 950	066842	Spare cutter head for 71 82 950 complete with screws							

Bolt End Cutting Nippers

high lever transmission

► Powerful, compact, comfortable

- > Better handling, greater capacity and lower handforce required compared to conventional bolt end cutting nippers
- > With cutting edges for soft, hard and piano wire
- > Particularly high cutting capacity with minimum effort due to optimum transmission ratio
- > Cutting edges additionally induction-hardened, cutting edge hardness approx. 64 HRC
- > Handles angled for better accessibility
- > Vanadium electric steel, forged, multi stage oil-hardened

61 02 200

- > With slim multi-component grips without collar for better handling and easier transport; with large contact surface on the handles for better allotment of pressure and more comfort at work



61 01 200



61 02 200



Extraordinary cutting performance: also for piano wire



Particularly efficient for fence construction



Almost flush cutting of bolts, nails etc.

Article No.	EAN 4003773-	↔ mm	Pliers	Head	Handles	Cutting capacities				△ g
						Ø mm	Ø mm	Ø mm	Ø mm	
61 01 200	033172	200	▶▶ ∠85° black atramentized	polished	plastic coated	1.0 – 6.0	4.0	3.5	3.0	435
61 02 200	067047	200	▶▶ ∠85° black atramentized	polished	with slim multi-component grips	1.0 – 6.0	4.0	3.5	3.0	435



High Leverage End Cutting Nippers

- > With cutting edges for soft, hard and piano wire
- > High cutting capacity with little effort due to optimum co-ordination of cutting edge angle and transmission ratio
- > Cutting edges additionally induction-hardened, cutting edge hardness approx. 64 HRC
- > Chrome vanadium heavy-duty steel, forged, multi stage oil-hardened
- > DIN ISO 5748



67 01 200



67 05 200

Article No.	EAN 4003773-	↔ mm		Pliers	Head	Handles	Cutting capacities				△ g
							☉ Ø mm	◐ Ø mm	◑ Ø mm	● Ø mm	
67 01 140	043690	140					4.0	3.1	2.0	1.5	152
67 01 160	040620	160	✚	black atramentized	polished	plastic coated	4.5	3.4	2.5	2.0	237
67 01 200	040637	200					5.0	3.8	3.0	2.5	318
67 05 140	017929	140					4.0	3.1	2.0	1.5	176
67 05 160	017936	160	✚	chrome plated	chrome plated	with multi-component grips	4.5	3.4	2.5	2.0	266
67 05 200	017943	200					5.0	3.8	3.0	2.5	361

End Cutting Nippers

- ▶ The head shape provides optimised movement when tightening steel mesh knots during reinforced concrete work

- > With cutting edges for soft and hard wire
- > Also suitable for twisting and cutting binding wire
- > Cutting edges additionally hardened; cutting edge hardness approx. 61 HRC
- > High-grade special tool steel, forged, multi stage oil-hardened
- > DIN ISO 5748



68 01 180



68 01 280

Article No.	EAN 4003773-	↔ mm		Pliers	Head	Handles	Cutting capacities			△ g
							☉ Ø mm	◐ Ø mm	◑ Ø mm	
68 01 160	013792	160					4.0	2.8	2.3	202
68 01 180	013808	180	✚	black atramentized	polished	plastic coated	4.0	3.2	2.5	284
68 01 200	013815	200					4.0	3.5	2.8	319
68 01 280	077664	280	✚	black atramentized	polished	plastic coated	4.5	4.0	3.2	465





Pipe Wrenches and
Water Pump Pliers

Pliers Wrenches	102
Pliers Wrench XL	104
Set of Pliers Wrenches	104
Protective jaws for Pliers Wrenches	105
KNIPEX TwinGrip – Slip Joint Pliers	106
Multiple Slip Joint Spanner	108
KNIPEX SmartGrip® – Water Pump Pliers	108
KNIPEX Cobra® XS – Hightech Water Pump Pliers	109
KNIPEX Cobra® – Hightech Water Pump Pliers	110
Protective jaws KNIPEX Cobra®	111
KNIPEX Cobra® XL / XXL – Hightech Water Pump Pliers	112
KNIPEX Cobra® -Set	113
KNIPEX Cobra® ...matic – Water Pump Pliers	113
KNIPEX Cobra® QuickSet – Hightech Water Pump Pliers	114
KNIPEX Cobra® VDE – Hightech Water Pump Pliers	115
KNIPEX Cobra® ES – Water Pump Pliers	115
KNIPEX Alligator® – Water Pump Pliers	116
KNIPEX Alligator® XL – Water Pump Pliers	118
Pipe Wrenches 90°	119
Pipe Wrenches 45°	119
Pipe Wrenches S-Type	120
Siphon and Connector Pliers	121

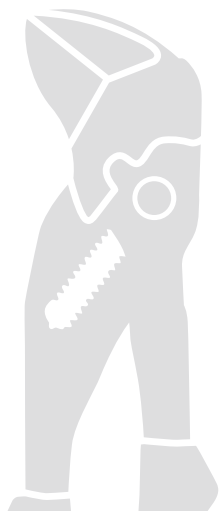

Pliers Wrenches

Pliers and a wrench in a single tool

- ▶ Replaces the need for sets of metric and imperial spanners
- ▶ Smooth jaws for damage free installation of plated fittings – working directly on chrome!

- > Adjustable tightening tool
- > Also excellent for gripping, holding, pressing and bending workpieces
- > Push the button for adjustment on the workpiece
- > Zero backlash jaw pressure prevents damage to edges of sensitive components
- > Parallel jaws give a more solid grip; its design allows flexible adjustment of all widths up to the specified maximum size
- > Reliable catching of the hinge bolt: no unintentional shifting
- > The ratchet type principle allows quick and easy tightening and release of all bolted connections
- > Lever transmission greater than 10 : 1 for strong gripping power
- > Fast adjustment by pushing a button directly on the workpiece
- > No unintentional shift of the gripping jaws and no slipping of the joint
- > Replaces the need for sets of metric and imperial spanners
- > Chrome vanadium electric steel, forged, oil-hardened

Length 100 mm

- > Pliers Wrench XS – although measuring only 100 mm, the width across flats is 21 mm

Length 150 mm

- > Ideal multi-purpose wrench in pocket size; indispensable companion in emergency tool kit

Length 180 mm

- > With narrow gripping jaws – for tightening situations that require a slim tool

86 01 180 / 86 01 250 / / 86 01 300 / 86 02 180 / 86 02 250 / 86 03 250 / 86 05 250 / 86 06 250

- > With scaling for presetting the width apart from the workpiece

86 43 250

- > 15° angled pliers handle provides space for counter screw connections or bolted fittings on surfaces

86 05 180 T / 86 05 250 T*

- > Pliers with tether attachment point for mounting a fall protection

The smooth jaws grip all parallel surfaces in the capacity range with a high degree of pressure if necessary and open up almost unlimited application possibilities for the pliers wrench: e.g. for tightening locknuts, exerting pressure to activate the adhesive power of contact adhesives, edge breaking in tile work, snapping cable ties, utilisation as a small vice.

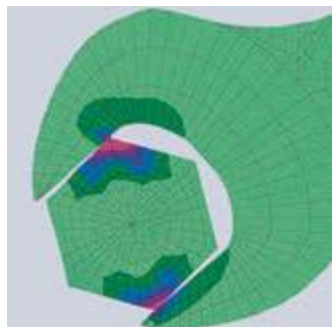

Conventional open end wrench: edge pressure causes surface damage

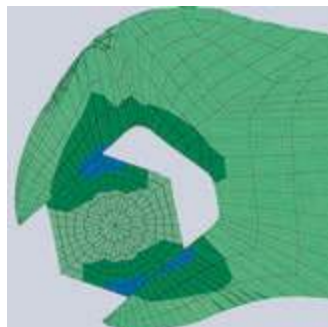

Pliers wrench: zero backlash contact pressure, no damage to edges



86 01 250



86 02 250



86 03 125



86 04 100

(PATENTED)



86 01 180



86 02 180



86 01 300



86 03 150



86 03 180



Working on plated fittings without damage of the surface



Replaces the need for sets of metric and imperial spanners



Ideal for bending operations

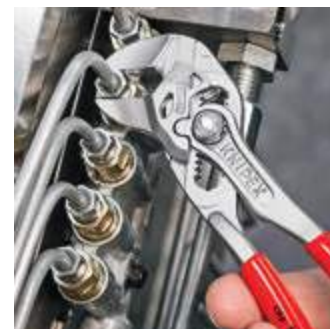

The mini pliers wrench for precision mechanics



Despite its small size, the Pliers Wrench XS grips nuts and parallel workpieces up to 21 mm safely and gently.



Fast adjustment at the touch of a button



Opening width lasered onto the pliers head (metric on the front and imperial on the back)



Due to the high lever transmission joint, the Pliers Wrench XS grips, presses and holds everything tightly

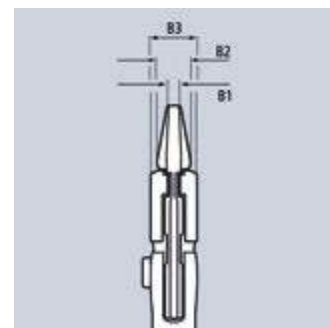

Article No.	EAN 4003773-	↔ mm		Pliers	Handles	Hex Inch	Hex mm	Adjustment positions	Dimensions			⚖ g
									B1 mm	B2 mm	B3 mm	
86 01 180	084273	180	▱	black atramentized	plastic coated	1 1/2	40	15	5.0	8.0	12.0	230
86 01 250	082385	250	▱	black atramentized	with non-slip plastic coating	2	52	19	8.0	8.0	14.0	465
86 01 300	084662	300	▱	black atramentized	with non-slip plastic coating	2 3/4	60	24	9.5	9.5	15.0	645
86 02 180	084280	180	▱	black atramentized	with multi-component grips	1 3/8	35	15	5.0	8.0	12.0	255
86 02 250	082392	250	▱	black atramentized	with multi-component grips	2	52	19	8.0	8.0	14.0	485
86 03 125	077497	125	▱	chrome plated	plastic coated	7/8	23	11	3.0	5.0	9.5	105
86 03 150	069676	150	▱	chrome plated	plastic coated	1	27	14	4.7	7.0	10.5	175
86 03 180	035466	180	▱	chrome plated	plastic coated	1 1/2	40	15	5.0	8.0	12.0	230
86 03 250	033837	250	▱	chrome plated	plastic coated	2	52	19	8.0	8.0	14.0	465
86 03 300	041429	300	▱	chrome plated	plastic coated	2 3/8	60	24	9.5	9.5	15.0	725
86 04 100	087281	100	▱	chrome plated	embossed, rough surface	3/4	21	10	2.5	5.5	10	70
86 05 150	069928	150	▱	chrome plated	with multi-component grips	1	27	14	4.7	7.0	10.5	193
86 05 180	047162	180	▱	chrome plated	with multi-component grips	1 1/2	40	15	5.0	8.0	12.0	260
86 05 180 T	080121	180	▱	chrome plated	with multi-component grips, with integrated tether attachment point for a tool tether	1 1/2	40	13	5.0	8.0	12.0	280
86 05 250	047841	250	▱	chrome plated	with multi-component grips	2	52	19	8.0	8.0	14.0	490
86 05 250 T	080138	250	▱	chrome plated	with multi-component grips, with integrated tether attachment point for a tool tether	2	52	19	8.0	8.0	14.0	500
86 06 250	082408	250	▱	chrome plated	insulated with multi-component grips, VDE-tested	2	52	19	8.0	8.0	14.0	525

Pliers Wrench XL

Pliers and a wrench in a single tool

- ▶ The unique installation tool now also in 400 mm length
- ▶ For opening widths up to 85 mm / 3 3/8"
- > Also excellent for gripping, holding, pressing and bending workpieces
- > Optimised adjustment to the workpiece with hand-friendly position of grips
- > Reliable catching of the hinge bolt: no unintentional shifting
- > Lever transmission greater than 10 : 1 for strong gripping power
- > Adjustable tightening tool
- > Replaces diverse expensive, large open-end wrenches up to AF 85 mm or 3 3/8"
- > Parallel jaws give a more solid grip; its design allows flexible adjustment of all widths up to the specified maximum size
- > Smooth jaws, for damage free installation of quality union joints made from brass, red brass or stainless steel
- > Zero backlash jaw pressure prevents damage to edges of sensitive components
- > The ratchet type principle allows quick and easy tightening and release of all bolted connections
- > Push the button for adjustment on the workpiece
- > Chrome vanadium electric steel, forged, oil-hardened



86 03 400

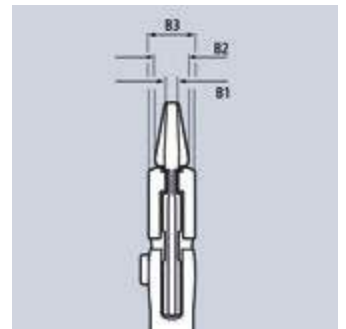

Article No.	EAN 4003773- 077312	↔ mm	Pliers	Handles	Inch	mm	Adjustment positions	Dimensions			⚖ g
								B1 mm	B2 mm	B3 mm	
86 03 400	077312	400	chrome plated	plastic coated	3 3/8	85	25	12.5	16.0	20.0	1460

Set of Pliers Wrenches

5-piece

- > Tool roll made of hard-wearing polyester fabric
- > With hook-and-loop fastener
- > Equipped with pliers wrenches in five different lengths from 125 to 300 mm
- > Dimensions, open (L x H): 430 x 325 mm



00 19 55 54

Article No.	EAN 4003773- 077817	Quantity	⚖ g
00 19 55 54	077817	1	2015
	▶ ◀	86 03 125	Mini Pliers Wrench, pliers and a wrench in a single tool
	▶ ◀	86 03 150	Mini Pliers Wrench, pliers and a wrench in a single tool
	▶ ◀	86 03 180	Pliers Wrench, pliers and a wrench in a single tool
	▶ ◀	86 03 250	Pliers Wrench, pliers and a wrench in a single tool
	▶ ◀	86 03 300	Pliers Wrench, pliers and a wrench in a single tool

Pliers Wrench

with roughened jaws especially for opening plastic cable connectors

- > Pliers wrench with special laser shearing for a good hold: grip, compress or loosen the head of the cable tie, all without cutting it
- > Roughened jaws for a better grip
- > Also excellent for gripping, holding, pressing and bending workpieces
- > No unintentional shift of the gripping jaws and no slipping of the joint
- > Lever transmission greater than 10 : 1 for strong gripping power
- > Fast adjustment by pushing a button directly on the workpiece
- > Infinitely variable gripping of parallel surfaces up to the specified capacity by means of parallel jaws
- > Zero-backlash, full-surface contact
- > Chrome vanadium electric steel, forged, oil-hardened



86 05 150 S02

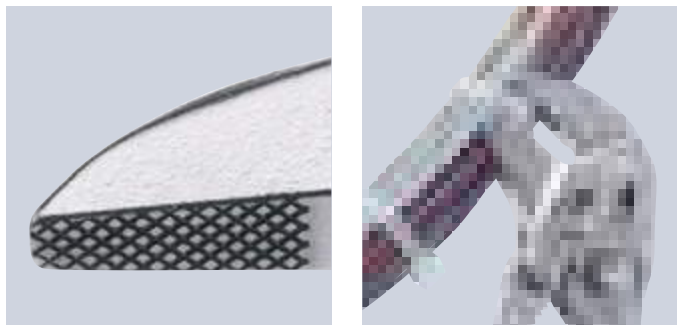

Article No.	EAN 4003773-	↔ mm		Pliers	Handles	⬡ Inch	⬡ mm	Adjustment positions	⚖ g
86 05 150 S02	071785	150	⊠	chrome plated	with multi-component grips	1	27	14	193

Protective jaws

for 86 XX 180 / 86 XX 250 / 86 XX 300

- > The perfect choice for designer fittings and other highly sensitive materials thanks to the soft, smooth gripping surfaces
- > Permits use on chrome if the jaws of the pliers wrench have been damaged due to improper or rough use
- > Easy to attach by hand and reliable fixing on the gripping jaws by means of an internal snap hook
- > Set consisting of 3 pairs of protective jaws made of plastic



86 09 250 V01



Article No.	EAN 4003773-	⚖ g
86 09 180 V01	085805	9
86 09 300 V01	085812	18
86 09 250 V01	084143	24

KNIPEX TwinGrip Slip Joint Pliers

The all-purpose solution for stuck workpieces, such as bolts and screws

- ▶ Unique combination: Front grip and side grip function, box-joint, push-button adjustment
- ▶ Very slim pliers let you work even in confined installation spaces with a narrow turning zone for fast results
- ▶ High-grip front jaw with robust teeth and high gear ratio at the tip of the mouth
- > Large front and side gripping capacity for diameters and widths across flats 4 - 22 mm
- > Reliable front gripping of flat workpieces due to the three-point system
- > Gripping, tightening and loosening screws with worn heads and threads
- > Five-way adjustable slip joint with push-button adjustment for precise adjustment of gripping capacity
- > Pinch stop reduces the risk of crushed fingers
- > Durable and resilient due to the robust box-joint
- > Forged from high-grade chrome vanadium electric steel, oil-hardened, teeth additionally induction-hardened to approx. 61 HRC



82 01 200



82 02 200



Comfortable and reliable: The push-button adjusts the gripping capacity in five steps directly on the workpiece and then locks securely – no accidental loss of adjustment!

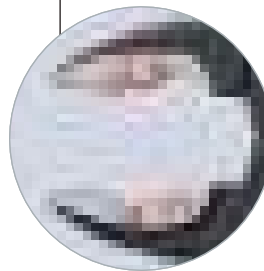

Optimised jaw geometry: 2-zone gripping jaw with opposing alignment of teeth – for maximum grip when loosening and tightening.



The KNIPEX TwinGrip allows the gripping capacity to be set flexibly in five positions...



...and the position to be changed quickly at the touch of a button!



The box-joint is robust and flexible, so that the pliers can hold workpieces between 4 and 22 mm in place.

Article no.	EAN	↔ mm	Pliers	Head	Handles	Adjustment positions	∅ Inch	∅ mm	∞ Inch	∞ mm	g
82 01 200	087243	200	black atramentized	polished	with non-slip plastic coating	5	5/32 - 7/8	4 - 22	5/32 - 7/8	4 - 22	270
82 01 200 SB	087571	200				5	5/32 - 7/8	4 - 22	5/32 - 7/8	4 - 22	270
82 02 200	087250	200			with multi-component grips	5	5/32 - 7/8	4 - 22	5/32 - 7/8	4 - 22	280
82 02 200 SB	087588	200				5	5/32 - 7/8	4 - 22	5/32 - 7/8	4 - 22	280

KNIPEX TwinGrip – Slip Joint Pliers

Front or sideways – they grab them all

Flexible. Handy. Strong.



Serrated gripping surfaces along the longitudinal axis of the pliers make it possible to grip worn bolts and screws tightly from the front



Multiple Slip Joint Spanner PATENTED

- > For metric and imperial nuts and screws with widths across flats from 10 to 32 mm (3/8" up to 1 1/4"); self-locking from 17 mm: no slipping on the workpiece
- > Zero-backlash gripping of metric or imperial hexagonal headed screws, no rounding of bolt heads
- > Reliable and tight gripping of rounded, rusty, or thick coated bolts and screws
- > Ideal for work on vehicle brake systems
- > Quick tightening of bolted connections using ratchet action
- > Push the button for adjustment on the workpiece, also possible with one hand only
- > Fine adjustment for optimum adaptation to different sizes of workpieces and a comfortable handle width
- > Box-joint design for high stability due to double guide
- > Reliable catching of the hinge bolt: no unintentional shifting
- > Favourable lever action: optimum transmission of force
- > Pinch guard prevents operators' fingers being pinched
- > Replaces a set of wrenches, ideal for tightening locknuts
- > Chrome vanadium electric steel, forged, multi stage oil-hardened



87 41 250



Self-locking: no slip on workpieces; less effort required



In operation on rusted nut with rounded edges required

The Raptor Pliers combines the convenience of the comfortable push-button adjustment on the workpiece and the function of an all-purpose tightening tool. Jaw gripping with zero backlash prevents slipping on the bolt head or rounding edges. Even rusty or thick coated bolted connections which have no surfaces capable of being gripped reliably by a conventional spanner can be managed by the exceptionally powerful closing gripping jaws of this spanner.



Article No.	EAN 4003773-	↔ mm		Pliers	Head	Handles	⬡ Inch	⬡ mm	Adjustment positions	⚖ g
87 41 250	054566	250	⚡	grey atramentized	polished	with non-slip plastic coating	3/8 - 1 1/4	10 - 32	15	328

KNIPEX SmartGrip® PATENTED

Water Pump Pliers with automatic adjustment

- > Ideal for frequent changeovers to workpieces of different sizes
- > Automatic adjustment per one-hand operation both for right-handed and left-handed use
- > Good access to the workpiece thanks to the slim dimensions of head and joint area and flush joint bolt
- > Self-locking on pipes and nuts: no slipping on the workpiece and low handforce required
- > Gripping surfaces with special hardened teeth, teeth hardness approx. 61 HRC: high wear resistance and stable gripping
- > Box-joint design for high stability due to double guide
- > Pinch guard prevents operators' fingers being pinched
- > Locking lever for space saving transport with reliable closed handles
- > Chrome vanadium electric steel, forged, multi stage oil-hardened
- > DIN ISO 8976



85 01 250

Adjustment to suit the workpiece is automatic with the KNIPEX SmartGrip®!

Place the outer jaw on the workpiece, squeeze the handles – turn!



Article No.	EAN 4003773-	↔ mm		Pliers	Head	Handles	⊠ Ø Inch	⊠ Ø mm	⬡ mm	⚖ g
85 01 250	061304	250	⚡	grey atramentized	polished	with non-slip plastic coating	1 1/4	32	36	370

KNIPEX Cobra® XS

PATENTED

- ▶ Optimum access in the narrowest spaces: an especially compact design with a very slim head
 - ▶ Single-handed fine adjustment by sliding for optimal fitting to various workpiece sizes
 - ▶ Long-lasting secure grip ensured by high wear resistance
- > Gripping capacity Ø 28 mm, width across flats up to 24 mm – at only 100 mm length
 - > Box joint: high quality and durability provided by dual guide
 - > Gripping surfaces with specially hardened teeth, hardness approx. 60 HRC
 - > Self-locking on pipes and nuts: no slipping on the workpiece and low handforce required
 - > Pinch guard prevents operators' fingers being pinched
 - > Fine adjustment with 11 adjustment positions
 - > DIN ISO 8976



87 00 100



Self-locking and durable – all part of genuine KNIPEX water pump pliers



Naked truth: The grips are not coated to keep them as slim as possible. To ensure good grip, they are texturised on the outside



Article No.	EAN	↔ mm	Pliers	Head	Handles	⊠ Ø Inch	⊠ mm	⬡ mm	Adjustment positions	⚖ g
87 00 100	4003773-085836	100	grey atramentized	polished	embossed, rough surface	1	28	24	11	62

KNIPEX Cobra®

Hightech Water Pump Pliers

- > Push the button for adjustment on the workpiece
- > Fine adjustment for optimum adaptation to different sizes of workpieces and a comfortable handle width
- > Self-locking on pipes and nuts: no slipping on the workpiece and low handforce required
- > Gripping surfaces with special hardened teeth, teeth hardness approx. 61 HRC: high wear resistance and stable gripping
- > Box-joint design for high stability due to double guide
- > Reliable catching of the hinge bolt: no unintentional shifting
- > Pinch guard prevents operators' fingers being pinched
- > Chrome vanadium electric steel, forged, multi stage oil-hardened
- > DIN ISO 8976

87 02 250 / 87 02 250 T / 87 05 250

- > With slim multi-component grips without collar for better handling and easier transport

87 02 180 T / 87 02 250 T / 87 02 300 T*

- > Pliers with tether attachment point for mounting a fall protection



87 01 125



87 01 250



87 01 300



87 02 180



87 02 250 T



87 03 250



87 05 250

KNIPEX Cobra® – the Hightech Water Pump Pliers.
 No more time-consuming presetting of the required opening size. Just position the upper jaw to the workpiece, push button and move close the lower jaw, ingeniously simple.



Fine adjustment by pushing a button: fast and comfortable



Fast and firm adjustment directly on the workpiece



Teeth set against the direction of rotation have a self-locking effect and prevent slipping on the workpiece.



Article No.	EAN 4003773-	↔ mm		Pliers	Head	Handles	∅ Inch	∅ mm	mm	Adjustment positions	Δ g
87 00 100	085836	100		grey atramentized	polished	embossed, rough surface	1	28	24	11	62
87 01 125	069935	125		grey atramentized	polished	with non-slip plastic coating	1	27	27	13	85
87 01 150	060116	150		grey atramentized	polished	with non-slip plastic coating	1 1/4	32	30	11	145
87 01 180	022015	180		grey atramentized	polished	with non-slip plastic coating	1 1/2	42	36	18	170
87 01 250	022022	250		grey atramentized	polished	with non-slip plastic coating	2	50	46	25	335
87 01 300	034087	300		grey atramentized	polished	with non-slip plastic coating	2 3/4	70	60	30	530
87 02 180	042396	180		grey atramentized	polished	with multi-component grips	1 1/2	42	36	18	196
87 02 180 T	080145	180		grey atramentized	polished	with multi-component grips, with integrated tether attachment point for a tool tether	1 1/2	42	36	18	200
87 02 250	040316	250		grey atramentized	polished	with slim multi-component grips	2	50	46	25	366
87 02 250 T	080152	250		grey atramentized	polished	with multi-component grips, with integrated tether attachment point for a tool tether	2	50	46	25	370
87 02 300	029144	300		grey atramentized	polished	with multi-component grips	2 3/4	70	60	30	580
87 02 300 T	080169	300		grey atramentized	polished	with multi-component grips, with integrated tether attachment point for a tool tether	2 3/4	70	60	30	600
87 03 125	073949	125		verchromt	verchromt	with non-slip plastic coating	1	25	27	13	85
87 03 180	005667	180		verchromt	verchromt	with non-slip plastic coating	1 1/2	42	36	18	175
87 03 250	043805	250		verchromt	verchromt	with non-slip plastic coating	2	50	46	25	335
87 03 300	041382	300		verchromt	verchromt	with non-slip plastic coating	2 3/4	70	60	30	530
87 05 250	005681	250		verchromt	verchromt	with slim multi-component grips	2	50	46	25	366
87 05 300	014126	300		grey atramentized	polished	with multi-component grips	2 3/4	70	60	30	580
87 09 125	074151	Assortment of spare parts for adjustment for 86 / 87-125									
87 09 150	074168	Assortment of spare parts for adjustment for 87 150									
87 09 180	034360	Range of spare parts adjustment for 87 180									

Protective jaws

3 pairs of smooth plastic protective jaws for the KNIPEX Cobra® 87 XX 180 / 250 / 300, updated models

- ▶ Ideal for protecting round workpieces from marring or scratching
- > The protective jaws prevent damage by covering all of the teeth on the tool
- > Easily and reliably fitted to the gripping jaws and firmly holds in place
- > Smooth gripping surfaces (no teeth)
- > Set consists of 3 pairs of plastic protective jaws



You can identify the updated models i.a. by the curved adjustment area.

Article no.	EAN 4003773-	Description	Δ g
87 09 180 V01	088066	3 pairs of plastic jaws for all 87 XX 180 mm models (models from 2010)	37
87 09 250 V01	088073	3 pairs of plastic jaws for all 87 XX 250 mm models (models from 2007)	40
87 09 300 V01	088080	3 pairs of plastic jaws for all 87 XX 300 mm models (models from 2008)	58

KNIPEX Cobra® XL / XXL

Water Pump Pliers

- > Greater gripping capacity but much lower weight than comparable pipe wrenches
- > Fast push-button adjustment directly on the workpiece, no unintentional slipping of the joint
- > Fine adjustment for optimum adaptation to different sizes of workpieces and a comfortable handle width
- > Self-locking on pipes and nuts: no slipping on the workpiece and low handforce required
- > Gripping surfaces with special hardened teeth, teeth hardness approx. 61 HRC: high wear resistance and stable gripping
- > Box-joint design for high stability due to double guide
- > Pinch guard prevents operators' fingers being pinched
- > Chrome vanadium electric steel, forged, multi stage oil-hardened
- > DIN ISO 8976



87 01 400

87 01 560

KNIPEX Cobra® XL
length 400 mm – weight 1195 g

gripping a union nut of a 2" pipe fitting
large gripping capacity of 95 mm,
would require a 3-inch pipe wrench



smaller dimensions and less weight than 1 1/2" pipe wrenches

2" pipe wrench
length 560 mm – weight 2670 g



gripping the 2" union nut exceeds the capacity of a 2" pipe wrench; no confident working conditions

Article No.	EAN	↔ mm		Pliers	Head	Handles	⊘ Inch	⊘ mm	⬡ mm	Adjustment positions	⚖ g
87 01 400	005636	400		grey atramentized	polished	plastic coated	3 1/2	90	95	27	1195
87 01 560	044321	560		grey atramentized	polished	plastic coated	4 1/2	115	120	20	2780
87 09 400	034391	Range of spare parts adjustment for 87 400									
87 09 560	049845	Range of spare parts adjustment for 87 560									

KNIPEX Cobra® Set

5-piece

- > High-quality roll-up bag made from durable polyester fabric
- > With hook-and-loop fastener
- > Equipped with KNIPEX Cobra® high-tech water pump pliers in five different lengths from 125 to 300 mm
- > Dimensions, open (L x H): 430 x 325 mm



00 19 55 55

Article No.	EAN			Quantity	g
00 19 55 55	4003773-082613		Cobra® Set, 5-piece		1575
			87 01 125	1	KNIPEX Cobra®, Hightech Water Pump Pliers
			87 01 150	1	
			87 01 180	1	
			87 01 250	1	
			87 01 300	1	
00 19 55 55 LE	082620		Roll-up case for pliers wrenches, empty		260

KNIPEX Cobra®...matic

Water Pump Pliers

- > All features of the KNIPEX Cobra® 87 01 250
- > Automatic adjustment at the touch of a button directly on the workpiece
- > The sheltered positioned spring ensures that the pliers close automatically once the push-button is activated (one-hand operation!)
- > Chrome vanadium electric steel, forged, multi stage oil-hardened
- > DIN ISO 8976



87 11 250



Article No.	EAN	↔ mm		Pliers	Head	Handles	∅ Inch	∅ mm	mm	Adjustment positions	g
87 11 250	035473	250		grey atramentized	polished	with non-slip plastic coating	2	50	46	25	335
87 19 250	022640	Spare spring for 87 11 250									

KNIPEX Cobra® QuickSet

PATENTED

Hightech Water Pump Pliers

- ▶ Fully open, push, grab!
- ▶ Additional fast adjustment on the workpiece by sliding the pliers handle
- > Combines the proven, reliable locking of the hinge bolt with an additional push function which makes it easier to work in very confined and inaccessible areas
- > The adjustment directly on the workpiece is possible by simply sliding the pliers handle
- > Reliable locking of the hinge bolt with the first workload. The gripping width of the pliers is then fixed and can only be adjusted by pressing the button
- > To re-activate the sliding function, the hinge bolt must be released by pressing the push button and the pliers must be completely opened again
- > Chrome vanadium electric steel, forged, multi stage oil-hardened
- > DIN ISO 8976



87 21 250



87 22 250

The KNIPEX Cobra® QuickSet combines all proven properties of the KNIPEX Cobra® with an additional push on function which makes it easier to work in very confined and inaccessible areas.

Adjustment directly on the workpiece is possible by simply sliding the pliers handle. The hinge bolt locks itself with the first workload. The gripping width of the pliers is then fixed and can only be adjusted by pressing the button. The hinge bolt must be released by pressing the button and the pliers must be completely opened once to activate the QuickSet function again.



Press the button – open pliers completely



Position jaw – simply slide and close pliers



Hinge bolt locks itself with the first workload



Article No.	EAN	↔ mm		Pliers	Head	Handles	∅ Inch	∅ mm	∅ mm	Adjustment positions	g
87 21 250	4003773-072775	250		grey afromentized	polished	with non-slip plastic coating	2	50	46	25	335
87 21 300	078524	300		grey afromentized	polished	with non-slip plastic coating	2 3/4	70	60	25	530
87 22 250	077794	250		grey afromentized	polished	with slim multi-component grips	2	50	46	25	366
87 29 01	079002	range of spare parts for 87 2x-250									
87 29 300	084570	range of spare parts for 87 21 300									

KNIPEX Cobra® VDE

Hightech Water Pump Pliers, insulated

- > Adjustment by shifting one jaw directly on to the workpiece: fast, reliable and comfortable handling
- > Fine adjustment: allows optimum adjustment to differently sized workpieces and comfortable handle position
- > Good access to the workpiece due to slim size of head and joint area
- > Self-locking on pipes and nuts: no slipping on the workpiece and low handforce required
- > Gripping surfaces with special hardened teeth, teeth hardness approx. 61 HRC: high wear resistance and stable gripping
- > Box-joint design for high stability due to double guide
- > Pinch guard prevents operators' fingers being pinched
- > Chrome vanadium electric steel, forged, multi stage oil-hardened
- > DIN ISO 8976, DIN EN 60900, IEC 60900



87 26 250



87 26 250 T

The adjustment action to adapt to the workpiece is easy and reliable with the KNIPEX Cobra® VDE: place the upper gripping jaw of the opened pliers on the workpiece, push pliers to close, done!

87 26 250 T*

- > Pliers with tether attachment point for mounting a fall protection

Article No.	EAN 4003773-	↔ mm		Pliers	Head	Handles	∅ Inch	∅ mm	∅ mm	Adjustment positions	⚖ g
87 26 250	071495	250		chrome plated	chrome plated	insulated with multi-component grips, VDE-tested	2	50	46	24	340
87 26 250 T	081517	250		chrome plated	chrome plated	insulated with multi-component grips, VDE-tested with integrated insulated tether attachment point for a tool tether	2	50	46	24	400
87 29 01	079002	range of spare parts for 87 2x-250									

KNIPEX Cobra® ES

Water Pump Pliers extra-slim

- > Ideal for service, maintenance and equipment repair, in automotive and general industry
- > Long, narrow jaws
- > Particularly good access to the workpiece due to very slim construction of head and joint area
- > Firm grip also on flat material due to three-point rest
- > Push the button for adjustment on the workpiece
- > Fine adjustment for optimum adaptation to different sizes of workpieces and a comfortable handle width
- > Self-locking on pipes and nuts: no slipping on the workpiece and low handforce required
- > Box-joint design for high stability due to double guide
- > Reliable catching of the hinge bolt: no unintentional shifting
- > Favourable lever action: optimum transmission of force
- > Pinch guard prevents operators' fingers being pinched
- > Chrome vanadium electric steel, forged, multi stage oil-hardened
- > DIN ISO 8976



Grips nuts up to 34 mm (1 5/8") across flats



Optimum access to the workpiece. Ideal for service, maintenance and equipment repair, in automotive and general industry



Very slim design in the complete head and joint area (compared to conventional water pump pliers)



87 51 250

Article No.	EAN 4003773-	↔ mm		Pliers	Head	Handles	∅ Inch	∅ mm	∅ mm	max. parallel opening width	max. gripping depth	Adjustment positions	⚖ g
87 51 250	061267	250		grey atramentized	polished	with non-slip plastic coating	1 1/4	32	34	37	42	19	328

*Other tools with tethering can be found from page 272

KNIPEX Alligator®

Water Pump Pliers

- ▶ Good access to the workpiece due to slim size of head and joint area
- ▶ More output and comfort compared to conventional water pump pliers of the same length: 9-notch adjustment positioning for 30 % more gripping capacity
- > Self-locking on pipes and nuts: no slipping on the workpiece and low handforce required
- > Gripping surfaces with special hardened teeth, teeth hardness approx. 61 HRC: high wear resistance and stable gripping
- > Box-joint design for high stability due to double guide
- > Robust construction, insensitive to dirt; particularly suitable for outdoor work
- > Pinch guard prevents operators' fingers being pinched
- > Chrome vanadium electric steel, forged, multi stage oil-hardened
- > DIN ISO 8976

88 02 250 / 88 02 250 T / 88 05 250

- > With slim multi-component grips without collar for better handling and easier transport

88 02 250 T / 88 02 300 T*

- > Pliers with tether attachment point for mounting a fall protection



88 01 180



88 02 250



88 02 250 T



88 02 300



88 02 300 T



88 03 250



88 05 250



88 05 300



Self-locking on pipes and nuts: no slipping on the workpiece; the complete actuating force can be used to turn the workpieces; not having to squeeze the pliers handles reduces the required effort

Conventional water pump pliers

KNIPEX Alligator® 250/300

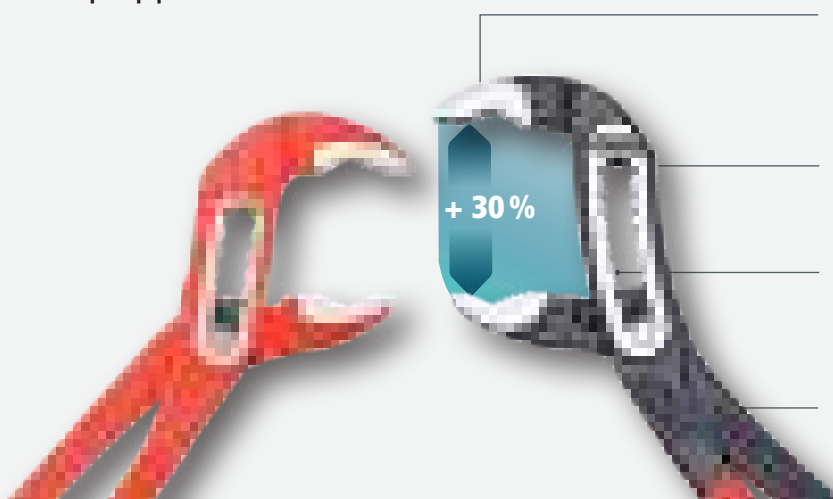

Specially hardened teeth
high resistance to wear, allowing durable, reliable gripping

Robust adjusting mechanism
insensitive to dirt, particularly suitable for outdoor work

Notch curved adjustment positioning
30% more gripping capacity, optimised adjustment to the workpiece and a handy handle position, slim design

Box joint, double guide
no loosening of the joint connection, continuous heavy duty

Article No.	EAN	↔ mm		Pliers	Head	Handles	∅ Inch	∅ mm	∅ mm	Adjustment positions	Δ g
88 01 180	035480	180					1 1/2	42	36	9	180
88 01 250	022992	250	▨	black atramentized	polished	with non-slip plastic coating	2	50	46	9	331
88 01 300	034094	300					2 3/4	70	60	9	511
88 02 180	044222	180	▨	black atramentized	polished	with multi-component grips	1 1/2	42	36	9	210
88 02 300	029151	300					2 3/4	70	60	9	565
88 02 300 T	080183	300	▨	black atramentized	polished	with multi-component grips, with integrated tether attachment point for a tool tether	2 3/4	70	60	9	595
88 02 250	019282	250	▨	black atramentized	polished	with slim multi-component grips	2	50	46	9	347
88 02 250 T	080176	250	▨	black atramentized	polished	with slim multi-component grips, with integrated tether attachment point for a tool tether	2	50	46	9	370
88 03 180	042860	180					1 1/2	42	36	9	181
88 03 250	005742	250	▨	chrome plated	chrome plated	with non-slip plastic coating	2	50	46	9	319
88 03 300	019312	300					2 3/4	70	60	9	499
88 05 180	060130	180	▨	chrome plated	chrome plated	with multi-component grips	1 1/2	42	36	9	210
88 05 300	042389	300					2 3/4	70	60	9	560
88 05 250	035497	250	▨	chrome plated	chrome plated	with slim multi-component grips	2	50	46	9	344
88 06 250	039303	250	▨ ⚡ 1000 V	chrome plated	chrome plated	insulated with multi-component grips, VDE-tested	2	50	46	9	374
88 07 250	019343	250	▨ ⚡ 1000 V	chrome plated	chrome plated	with dipped insulation, VDE-tested	2	50	46	9	420
88 07 300	022350	300					2 3/4	70	60	9	661

KNIPEX Alligator® XL

Water Pump Pliers

- ▶ The classic model, now also in 400 mm length
 - ▶ Robust construction, insensitive to dirt; particularly suitable for outdoor work
- > Good access to the workpiece due to slim size of head and joint area
 - > Pinch guard prevents operators' fingers being pinched
 - > Gripping surfaces with special hardened teeth, teeth hardness approx. 61 HRC: high wear resistance and stable gripping
 - > Self-locking on pipes and nuts: no slipping on the workpiece and low handforce required
 - > Box-joint design for high stability due to double guide
 - > Robust adjustment mechanism, insensitive to dirt, easy to clean; particularly suitable for outdoor work
 - > 11-notch adjustment positioning with a gripping capacity up to 3 1/2", optimised adjustment to the workpiece and user-friendly handle position
 - > Chrome vanadium electric steel, forged, multi stage oil-hardened
 - > DIN ISO 8976



88 01 400

The KNIPEX Alligator® XL offers the performance and comfort of a water pump pliers while being 50 % lighter in weight and having a greater gripping capacity (3 1/2") than comparable pipe wrenches. With their handy length of 400 mm, there is a place for KNIPEX Alligator® XL in every tool box.



Robust pliers for very hard applications

Gripping surfaces with special hardened teeth, teeth hardness approx. 61 HRC: low wear and stable gripping

Self-locking on pipes and nuts: no slipping on the workpiece and low handforce required

Box-joint design: high stability because of the double guide

Robust adjustment mechanism, insensitive to dirt, easy to clean; particularly suitable for outdoor work

11-notch adjustment for a gripping capacity up to 3 1/2", optimised adjustment to the workpiece and a comfortable handle position



Article No.	EAN	↔ mm		Pliers	Head	Handles	∅ Inch	∅ mm	∅ mm	Adjustment positions	⚖ g
88 01 400	075844	400		black atramentized	polished	with non-slip plastic coating	3 1/2	90.0	95.0	11	1190

Pipe Wrenches 90°

- > Swedish pattern
- > 90° angled jaws
- > Jaws with offset teeth in opposite direction
- > Teeth additionally induction-hardened
- > I-beam handle design
- > Captive adjusting nut
- > Red powder-coated, jaws bright ground
- > Chrome vanadium electric steel, forged, multi stage oil-hardened
- > DIN 5234



83 10 015



Article No.	EAN 4003773-	↔ mm		Pliers	∅ Inch	∅ mm	Inch	⚖ g
83 10 010	014188	310		red powder-coated	1 5/8	42	1	779
83 10 015	014195	420			2 3/8	60	1 1/2	1415
83 10 020	014201	560			2 3/4	70	2	2600
83 10 030	022329	650			4 3/8	110	3	3433
83 10 040	022336	750			5 1/8	130	4	4921

Pipe Wrenches 45°

- > Swedish pattern
- > 45° angled jaws
- > Jaws with offset teeth in opposite direction
- > Teeth additionally induction-hardened
- > I-beam handle design
- > Captive adjusting nut
- > Red powder-coated, jaws bright ground
- > Chrome vanadium electric steel, forged, multi stage oil-hardened
- > DIN 5234



83 20 015

Article No.	EAN 4003773-	↔ mm		Pliers	∅ Inch	∅ mm	Inch	⚖ g
83 20 010	014218	320		red powder-coated	1 5/8	42	1	817
83 20 015	014225	430			2 3/8	60	1 1/2	1408
83 20 020	014232	570			2 3/4	70	2	2596



Pipe Wrenches S-Type

- > Slim, S-type jaw
- > Jaws with offset teeth in opposite direction
- > Teeth additionally induction-hardened
- > Three-point contact on pipes, self-locking
- > I-beam handle design
- > Captive adjusting nut
- > Red powder-coated, jaws bright ground
- > Chrome vanadium electric steel, forged, multi stage oil-hardened
- > DIN 5234



83 30 015



Article No.	EAN 4003773-	↔ mm		Pliers	 Ø Inch	 Ø mm	 Inch	 g	
83 30 005	025221	245		red powder-coated		1 1/2	35	1/2	472
83 30 010	014249	320				1 5/8	42	1	836
83 30 015	014256	420				2 3/8	60	1 1/2	1540
83 30 020	014263	540				2 3/4	70	2	2669
83 30 030	014164	680				4 3/4	120	3	4366

Pipe Wrenches S-Type

PATENTED

with fast adjustment

- > Pinch guard prevents operators' fingers being pinched
- > Time-saving, precise adjustment of the gripping width directly on the workpiece at the push of a button
- > Less effort required due to self-locking action
- > No unintentional shifting of the pliers handles
- > High wear resistance due to the additionally hardened teeth
- > Maximum load capability thanks to completely hardened handles
- > Chrome vanadium electric steel, forged, multi stage oil-hardened



83 60 010



83 61 010



Article No.	EAN 4003773-	↔ mm		Pliers	Handles	 Ø Inch	 Ø mm	 Inch	 g		
83 60 010	075424	330		red powder-coated			1 5/8	42	1	955	
83 60 015	075677	420						2 3/8	60	1 1/2	1470
83 60 020	078838	560						2 3/4	70	2	2420
83 61 010	077602	330			grey powder-coated	plastic coated		1 5/8	42	1	955
83 61 015	077619	420							2 3/8	60	1 1/2
83 61 020	078876	560						2 3/4	70	2	2480

Siphon and Connector Pliers

for traps, tube fittings and connectors

- ▶ Fine adjustment for ideal adjustment to diverse diameters
- ▶ For siphons, oil filters, plastic pipes and connectors up to 80 mm diameter
- ▶ Robust, heavy duty

- > Ideal for tightening and loosening siphon screw connections, plastic pipe fittings and round union nuts
- > For connectors and couplings with screw connection, such as Cannon circular connectors
- > For gentle loosening of hoses on nozzles and filter cartridges
- > Optimum adhesion on dirt-, oil- and fatfree surfaces
- > 25 adjustment positions, box-joint design
- > Ergonomic handle geometry
- > Chrome vanadium electric steel, forged, oil-hardened
- > DIN ISO 8976

81 01 250 / 81 03 250

> With serrated gripping jaws; up to Ø 80 mm

81 11 250 / 81 13 250

> With exchangeable plastic jaws for sensitive surfaces; up to Ø 75 mm



81 01 250



81 03 250



81 11 250



81 13 250

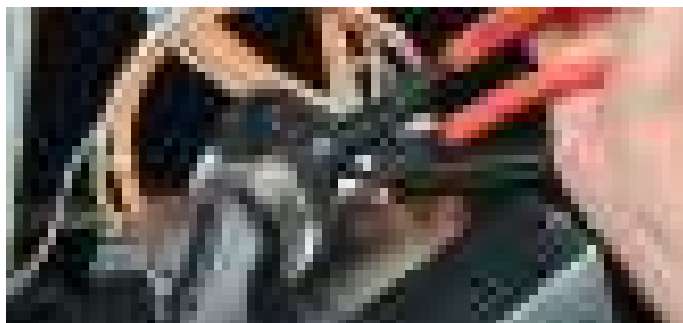

Article No.	EAN 4003773-	↔ mm		Pliers	Head	Handles	Working Capacity Ø mm	Adjustment positions	Δ g
81 01 250	078463	250		black atramentized	polished	with non-slip plastic coating	25 - 80	25	355
81 03 250	078487	250		chrome plated	polished	with non-slip plastic coating	25 - 80	25	355
81 11 250	078470	250		black atramentized	polished	with non-slip plastic coating	10 - 75	25	355
81 13 250	078494	250		chrome plated	chrome plated	with non-slip plastic coating	10 - 75	25	355
81 19 250 V01	078500	2 pairs of plastic inserts 1C for 81 11 250 / 81 13 250							
81 19 250 V02	086550	2 pairs of plastic inserts 2C for 81 11 250 / 81 13 250							

Pipe Cutter



Award-winner:
Winner of the EISEN
Innovation Award 2020

Pipe cutters for multilayer and pneumatic hoses	124
KNIPEX PlastiCut® – Cutter for flexible hoses and plastic conduit pipes	124
KNIPEX TwistCut® – Corrugated pipe cutters	125
KNIPEX BiX – Cutter for plastic pipes and sealing sleeves	126
KNIPEX DP50 – Pipe Cutter for plastic drain pipes	127
Pipe Cutter for composite pipes and protective tubes	128
Pipe Cutter for composite and plastic pipes	128, 130
Pipe Cutter for plastic composite pipes	129
KNIPEX TubiX® – Pipe Cutter	131
KNIPEX TubiX® XL – Pipe Cutter	132
Pipe Cutter for plastic conduit pipes	133



Pipe cutters for multilayer and pneumatic hoses

- ▶ Ideal for all liquid, multilayer and pneumatic hoses/pipes commonly available on the market in the wide application range from Ø 4 – 20 mm
 - ▶ With universal support for right-angled positioning
 - ▶ Easy on the hands even in continuous use thanks to low force required and automatic opening thanks to the spring mechanism
- > Exchangeable blade
 - > With opening spring and locking device
 - > Ergonomically designed glass-fibre reinforced plastic handles
 - > Not suitable for cutting cables
 - > Blade made of high-strength special grade steel, oil-hardened and tempered



90 10 185



Article No.	EAN 4003773-	↔ mm	Cutting capacities Ø mm	⚖ g
90 10 185	084846	185	4 – 20	175
90 29 01	031932	Spare blade for 90 25 20 / 90 10 185 / 90 25 185		

KNIPEX PlastiCut®

Cutter for flexible hoses and plastic conduit pipes

- > For cutting thin walled plastic pipes (conduit plastic pipes) and flexible hoses, also with fabric reinforcement, of plastic and rubber up to 25.0 mm / 1" exterior dia.
- > Not suitable for cutting cables
- > With opening spring and locking device
- > Blades: special tool steel, oil-hardened, interchangeable
- > Tool body: plastic, fibreglass-reinforced



With replaceable blade



90 20 185

Article No.	EAN 4003773-	↔ mm		Cutting capacities Ø mm	⚖ g
90 20 185	067122	185	MM	25	172
90 29 185	067139	Spare blade for 90 20 185			

KNIPEX TwistCut®

Corrugated pipe cutters

- > For corrugated plastic pipes from Ø 13 – 32 mm and a ridge width of up to 2.7 mm
- > For cutting empty or ready-assembled corrugated pipes to length
- > Application in the electrical and construction trades and for plumbing work
- > Recessed blades prevent injuries
- > Exact, flush cut, without damaging the internal cables
- > Cut on the outside of fluting – no sharp raw edge inside the corrugated pipe
- > Fast and reliable work
- > Simple insertion of the corrugated pipe for reliable and simple cutting: no waste
- > In the case of thick-walled corrugated pipes, reapply after the circular cut just behind the cut, and break off the corrugated pipe
- > Slim and ergonomically shaped for work in poorly accessible areas
- > Double-sided guide for a precise cut
- > For corrugated pipes with Ø of 13 – 32 mm
- > Body made of stable polyamide compound plastic



90 22 01 SB



90 22 02 SB



Convenient handling due to fastener with locking device and opening by means of internal spring



Also for protective pipes on aluminium composite pipes in plumbing, up to a diameter of 32 mm



Clean cutting edge with no damage to internal cables as the cut is always at the top of the corrugation



Easy to use: press KNIPEX TwistCut® together, turn with slight pressure, done

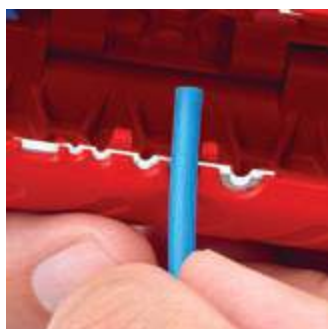

90 22 02 SB: Practical locator simplifies the insertion of single conductors for stripping



90 22 02 SB: Injection moulded length scale for consistent stripping to a uniform length, legible for left and right handed users

Article No.	EAN 4003773-	↔ mm		Cutting capacities Ø mm	Wire stripping value for conductors and strands Ø mm	⚖ g
90 22 01 SB	082286	100	⌘	13 – 32		47
90 22 02 SB	082293	100	⌘	13 – 32	0.2 – 4	47

KNIPEX BiX Cutter for plastic pipes and sealing sleeves

Practical tool for plumbers and electricians: Cuts plastic pipes and sealing sleeves quickly and efficiently

- ▶ Clever pipe cutter: Cuts pipes without shavings and fits comfortably in the hand
 - ▶ Can cut high-temperature plastic drain pipes and electrical conduits in next to no time
 - ▶ Can be used to cut sealing sleeves during final assembly – close to the wall, standard-compliant
- > Cuts unreinforced plastic pipes from Ø 20 to 50 mm with a wall thickness of up to 2.4 mm
 - > Cuts pipes quickly, cleanly and without shavings
 - > Cuts sealing sleeves approx. 2 – 3 mm from the wall
 - > Rotatable knife block for cutting plastic pipes (blade in the middle) and sealing sleeves (blade outside)
 - > With locking mechanism for safe transport
 - > Two spare blades integrated in the tool
 - > Tool made of stable, reinforced plastic, die-cast zinc blade unit
 - > Blades made of special surgical stainless steel – Made in Solingen

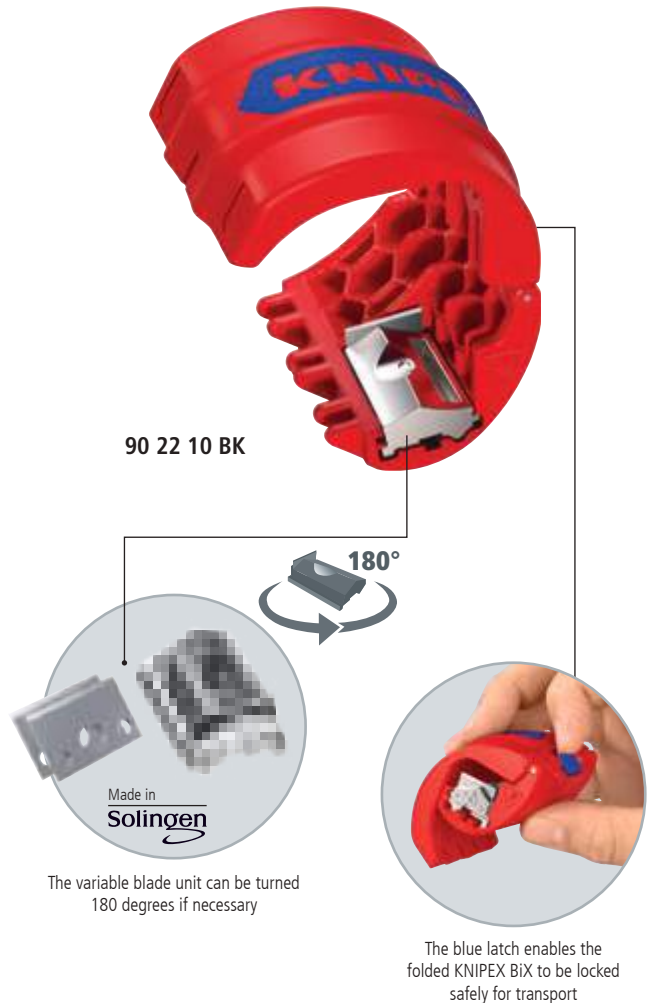

Practical, quick and clean: Plastic pipes can be cut in no time and sections are held securely in the tool

Follow DIN 18534 standards in your work right now:
Drip and sealing sleeves protect walls against long-term damage from leaks.



The unique design of the rotating blade unit means that drip and sealing sleeves can be reliably cut 2 to 3 mm from the wall, so that moisture can be safely drawn away

Article no.	EAN 4003773- 087311	↔ mm	Cutting values for HT and plastic pipes Ø mm	Cutting values for sealing sleeve Ø mm	⚖ g
90 22 10 BK	087311	72	20 – 50	20 – 50	108
90 22 10 E01	087564	Spare blades for 90 22 10 BK			8

KNIPEX DP50

Pipe Cutter for plastic drain pipes

One tool, two functions, three diameters: cut common domestic plastic wastewater pipes quickly and easily

- ▶ Cut and chamfer all common domestic plastic drain pipes up to Ø 50 mm in a single operation
 - ▶ Reversible high-quality ball-bearing steel blade, can be easily replaced without tools
 - ▶ Clean cut: no readjusting or deburring required, reducing potential blockages or damages of the seals
- > Cuts high temperature and other plastic pipes with Ø 32, 40 or 50 mm and wall thicknesses up to 2.4 mm
- > Optimal cutting due to slide-bearing and self-adjusting guide rolls
- > Easy positioning due to clear view of cutting point
- > Spring-loaded blade: no inconvenient readjusting while cutting
- > Exchangeable blade with two cutting edges can be reversed when showing signs of wear
- > Cuts lengths as small as 10 mm
- > Durable housing made of glass fibre reinforced plastic

Squeeze the blue lever to position the blade against the pipe



90 23 01 BK



Once in place, the spring-loaded blade exerts enough pressure for the cut – no readjustment necessary!



Three diameters with one tool: the pipe diameter can be preset with the metal adjuster

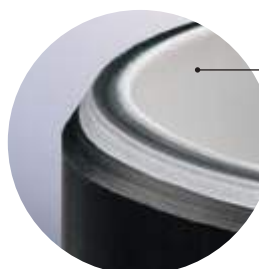

In a single operation the blade cuts the pipe and forms the chamfer for a proper connection



Segments as short as 10 mm can be cut. The spiral chip comes from chamfering



When worn, the blade can be reversed or replaced without the need for tools

Article no.	EAN	↔	Ø mm	⚖
	4003773-	mm		g
90 23 01 BK	087809	202	32 / 40 / 50	294
90 23 01 E01	088103	Double-sided spare blade for 90 23 01		6
90 23 01 E02	088110	Spare locking pin for blade for 90 23 01		3

Pipe Cutter

for composite pipes and protective tubes

- > For cutting composite pipes with diameters from 12.0 to 25.0 mm and for cutting flexible protective tubes with a diameter of 18.0 – 35.0 mm without damaging a potential pipe inside
- > A calibration arbor can be fitted, for example for Geberit composite pipes with 11.5 and 15.0 mm dia.
- > Blades: special tool steel, oil-hardened, interchangeable
- > Tool body: high-grade chrome vanadium electric steel, oil-hardened



90 25 20



Clean cut of protective tubes 18 - 35 mm diameter



Composite pipes of 12 - 25 mm dia. are cut cleanly and without deformation

Article No.	EAN 4003773-	↔ mm		Tool	Handles	Cutting capacities composite pipes Ø mm	Cutting capacities protective tubes Ø mm	Blade length mm	Δ g
90 25 20	046004	210	MM	galvanized	with multi-component grips	12 – 25	18 – 35	25	332
90 29 01	031932	Spare blade for 90 25 20 / 90 10 185 / 90 25 185							
90 29 02	031949	1 pair of spare blades for 90 25 20 (protective pipes)							
90 29 15	031956	Calibration arbor for 90 25 20 (Geberit pipes)							

Pipe Cutter

for composite and plastic pipes

- > For cutting thick walled plastic and composite pipes with diameters
- > Cuts pipes using the ratchet principle in several strokes
- > Self-adapting pipe support positions pipes of various diameters correctly for a rectangular cut
- > Blades: special tool steel, oil-hardened, interchangeable
- > Tool body: high-grade chrome vanadium electric steel, oil-hardened



90 25 40



Clean cut of thick walled plastic and composite pipes



Not suitable for thin-walled plastic pipes. Please use article number 90 20 185 or 94 10 185 for these

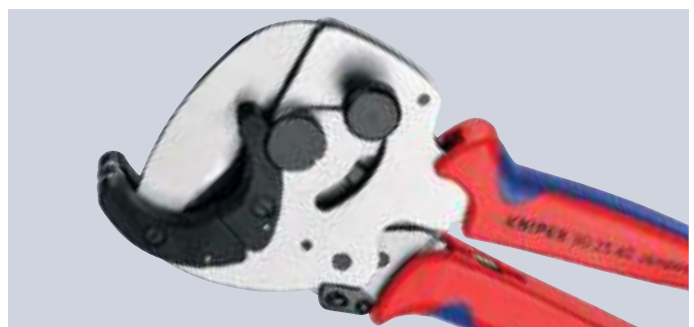

Article No.	EAN 4003773-	↔ mm		Tool	Handles	Cutting capacities Ø mm	Cutting edge length mm	Δ g	
90 25 40	045182	210	MM	galvanized	with multi-component grips	26 – 40	40	500	
90 29 40	045199	Spare blade for 90 25 40							

Pipe Cutter for plastic composite pipes

- ▶ For cutting composite pipes from Ø 12 – 25 mm
 - ▶ Clean, smooth and burr-free cut surfaces
 - ▶ Easily exchangeable blades
- > With opening spring and locking device
 > Ergonomically designed glass-fibre reinforced plastic handles
 > Not suitable for cutting cables
 > Blade made of high-strength special grade steel, oil-hardened and tempered



90 25 185



The high-strength, sharp blade cuts composite and plastic pipes smoothly and free of burr

Article No.	EAN 4003773-	↔ mm	Cutting capacities Ø mm	⚖ g
90 25 185	084839	185	12 – 25	175
90 29 01	031932	Spare blade for 90 25 20 / 90 10 185 / 90 25 185		



Pipe cutter for composite and plastic pipes

This intelligent combination of shears and pipe cutter cuts more easily than conventional shears with a fixed blade

- ▶ Up to 60 % less effort: the freely rotating cutting wheel allows the pipe to be rotated with minimal friction when cutting
- ▶ Optimal cutting results: the rotation allows the cutting wheel to penetrate the pipe effortlessly with minimal deformation
- ▶ Wide plastic supports allow perfect right-angled cuts

- > Cuts aluminium composite and plastic conduit pipes more easily than conventional shears with a fixed blade
- > Also suitable for composite pipes with increased aluminium layer thickness (e.g. Geberit Mepla)
- > For cutting composite and plastic conduit pipes up to Ø 26 mm
- > Allows for very short correction sections
- > With locking mechanism for safe transport
- > With ergonomic multi-component grips
- > Oil hardened, replaceable cutting wheel made of special tool steel
- > Replacement cutting wheel available (Art. No. 90 25 25 E01)
- > Special quality chrome vanadium electric steel, oil-hardened

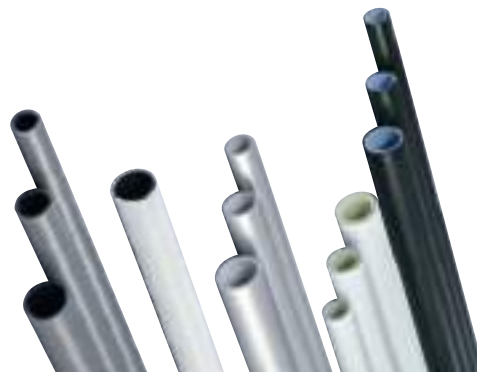

The pipe cutter cuts all common composite and plastic conduit pipes with diameters of up to 26 millimetres. Its robust construction means it is also suitable for composite conduit pipes with increased aluminium layer thickness.



Makes cutting particularly easy: the rotating cutting wheel allows the pipe to be rotated in the pipe cutter with little friction, or, vice versa, the pipe cutter can be rotated around the pipe.



The rotary movement means the pipe can also be cut with little pressure, minimising deformation.

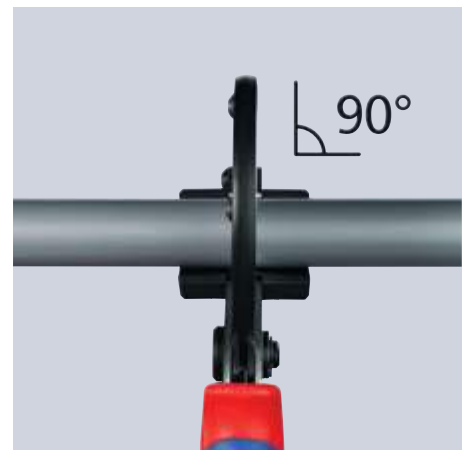

The wide plastic supports opposite the cutting wheel allow perfect right-angled cuts.

	Capacity Ø mm	⚖ g
90 25 25	up to 26	390
90 25 25 E01	Spare cutting wheel	

KNIPEX TubiX Pipe Cutter

Faster, easier and more precise: cuts copper, brass and stainless steel pipes

- ▶ QuickLock single-handed quick adjustment: slide on, cut – finished!
- ▶ Easy one-handed pushing for quick adjustment to different tube sizes
- ▶ Comfortable and easy working thanks to high-quality needle bearings in the cutting wheel and the guide rolls

- > Cuts pipes from Ø 6 – 35 mm (1/4" – 1 3/8") with wall thickness up to 2 mm
- > Cutting wheel made of high-grade ball-bearing steel
- > Practical quick replace system for the cutting wheel – with spare wheel stored under the feeding barrel
- > With precision-ground deburring tool, easy to remove
- > For the electric trade: Also suitable to cut rigid steel conduits
- > Light and durable metal enclosure of magnesium



For cutting copper, brass and stainless steel pipes with wall thickness up to 2 mm and diameters of 6 – 35 mm (1/4" – 1 3/8")



Speed in everyday operation: the QuickLock single-handed quick adjustment enables the cutting wheel to slide onto any pipe diameter with a single press of the thumb

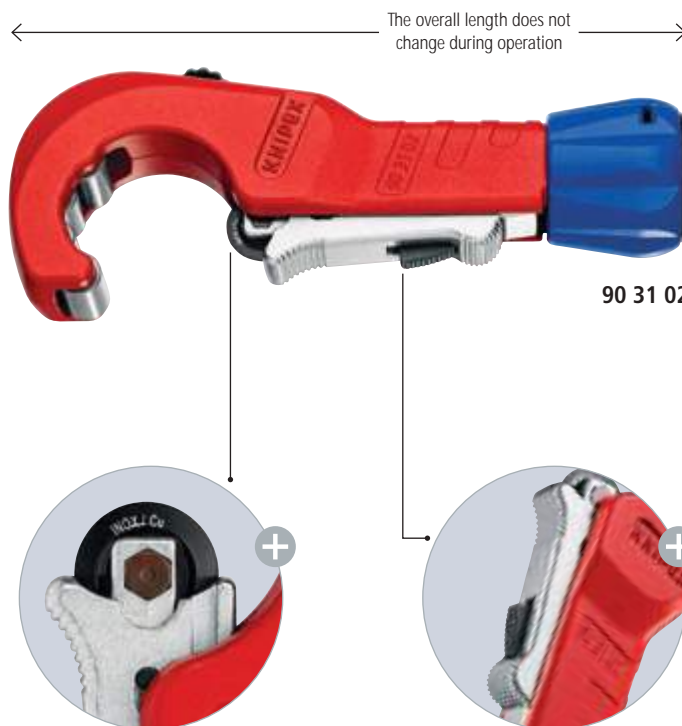

90 31 02

The needle-bearing and spring-loaded cutting wheel made of high-quality ball bearing steel is easily exchangeable

The spring-loaded cutting wheel can be pushed and fixed on the diameter of the pipe with the single-handed quick adjustment



High-quality needle bearings enable the cutting wheel and the four guide rollers to operate virtually without any friction during the cutting – cuts stainless steel pipes with particular ease

Four steps to success – how the KNIPEX TubiX pipe cutter helps you in your work



1 Cutting now made easy: position the opened KNIPEX TubiX...



2 Push the cutting wheel against the pipe with the QuickLock single hand quick adjustment: fastest adjustment to different pipe diameters



3 Tighten and cut with a swift twist and then readjust using the ergonomic blue feeding barrel...



4 and you're done! If necessary, have the edge smoothed out using the fold-out deburring tool – with surprisingly little effort

Article No.	EAN	↔	Ø mm	Ø Inch	⚖
	4003773-	mm			g
90 31 02 SB	084686	180	6 – 35	1/4" – 1 3/8"	375
90 31 02 BK	084907	180	6 – 35	1/4" – 1 3/8"	375
90 39 02 V01	085874	Cutting wheel INOX Cu for 90 31 02			8
90 39 02 V02	085881	Deburring tool for 90 31 02			7
90 39 02 V03	086307	5x Cutting wheel INOX Cu for 90 31 02			25



KNIPEX TubiX XL Pipe Cutter

Significantly easier pipe cutting due to the combination of the QuickLock mechanism and guide rollers with needle-bearings

- ▶ Spring-loaded QuickLock mechanism holds the tool on the pipe once locked in place
 - ▶ Precise and quick: exact positioning of the cutting wheel on the pipe
 - ▶ High-quality needle-bearings enable the cutting wheel and four guide rollers to cut with ease
- > Cuts pipes from Ø 6 – 76 mm (1/4" – 3") and a wall thickness up to 2 mm
 - > Cutting wheel made of high-grade ball-bearing steel
 - > Quick replacement of the cutting wheel without any tools needed – spare cutting wheel stored in the handle
 - > Lightweight and durable aluminium housing
 - > Removable, precision-ground deburring tool
 - > For plumbing, heating and air conditioning: easily cut gas and water pipes made of copper, brass and stainless steel
 - > For the electrical trade: cuts rigid steel conduits and for stripping steel wire armoured cables



90 31 03

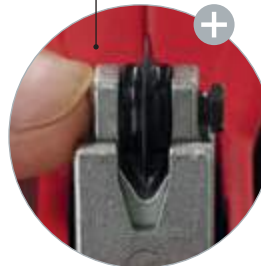

The needle-bearred and spring-loaded cutting wheel made of high-quality ball bearing steel is easily exchangeable



For cutting copper, brass and stainless steel pipes with a wall thickness up to 2 mm and diameters from 6 to 76 mm (1/4" – 3")



QuickLock locking mechanism

The spring-loaded cutting wheel keeps the KNIPEX TubiX® XL in place and prevents slipping



In one easy step, the KNIPEX TubiX® XL can be positioned quickly and precisely on all pipes with a diameter between 6 and 76 mm



High-quality needle-bearings in the guide rollers and the cutting wheel reduce the friction for easier cutting.



A spare cutting wheel is stored in the blue handle for quick replacement



The precisely ground deburring tool can be taken out of the tool when needed.

Article no.	EAN	↔	Ø mm	Ø Inch	⚖
	4003773-	mm			g
90 31 03 BK	088127	ca. 256	6 – 76	1/4 – 3	865
90 31 03 E01	088134	Deburring tool for KNIPEX TubiX® XL 90 31 02 and KNIPEX TubiX® XL 90 31 03			7
90 39 02 V01	085874	Cutting wheel for stainless steel and copper for KNIPEX TubiX® 90 31 02 and KNIPEX TubiX® XL 90 31 03			9
90 39 02 V03	086307	5 x Cutting wheel for stainless steel and copper for KNIPEX TubiX® 90 31 02 and KNIPEX TubiX® XL 90 31 03			25

Pipe Cutter

for plastic conduit pipes (electrical installation work)

- > For clean cutting of thin-walled plastic pipes (e.g. plastic conduit pipes) with \varnothing 6.0 – 35.0 mm
- > Not suitable for cutting cables
- > Blade is replaceable and can be retracted from any position
- > Low force requirement due to special blade geometry and optimum transmission
- > Minimum operator fatigue due to ergonomic handle design and incremental ratchet blade feed
- > Blade: special tool steel, oil-hardened
- > Housing: die-cast aluminium, red lacquered



94 10 185



Article No.	EAN	↔ mm		Body	Cutting capacities \varnothing mm	Cutting edge length mm	△ g
94 10 185	4003773-047025	185	MM	die-cast aluminium body, red lacquered	6 – 35	35	583
94 19 185	047032	Spare blade for 94 10 185					
94 19 02	052333	Blade support for 94 15 215					

Special Pliers and Control Cabinet Keys



Ear Clamp Pliers	136
KNIPLEX CutiX – Universal knife	137
Anvil Shears	138
Cutter for ribbon cable	138
Mitre Shears for plastic and rubber sections	139
Vinyl Shears	139
Shears for KEVLAR® fibres	140
Combination Shears	140
Punch Lock Riveters	141
Sheet Metal Nibbler	141
Notching Pliers	142
Cycle Pliers	142
Spring Hose Clamp Pliers	143
Hose Clamp Pliers for Click clamps	144
Revolving Punch Pliers	145
Tile Nibbling Pincer	145
Parrot Beak Pincer	145
Upholstery Pliers	145
Tile Breaking Pliers	146
Material catcher	146
KNIPLEX TwinKey® – Control Cabinet Key	147
Control Cabinet Keys	147
Profi-Key	148
Universal Key	148
Universal Key “Construction”	148
Control Cabinet Key “DoubleJoint”	149
Pen-Style Control Cabinet Key	149



Ear Clamp Pliers

Suitable for universal use, for 1-ear and 2-ear clamps

- > For the simple and reliable mounting of 1-ear and 2-ear clamps (Oetiker system or similar)
- > No damage to press points on the ear clamps
- > The slim head permits good accessibility in confined areas
- > Versatile use for clamps on CV boots, cooler and fuel lines, air pressure systems, compressors
- > Durable and strong
- > High-grade special tool steel, forged, oil-hardened

10 99 I220

- > Especially suitable for universal use thanks to the additional side jaw



10 98 I220



10 99 I220



Using the front press nib



Sealing the fluid hose on the connecting piece using the side press nib



Sealing the pneumatic hose on the quick action coupling



Article No.	EAN	↔ mm	Pliers	Head	Handles	⚖ g
10 98 I220	4003773-080749	220	black atramentized	polished	plastic coated	363
10 99 I220	4003773-080756	220	black atramentized	polished	plastic coated	345

KNIPEX CutiX Universal knife

A reliable helper with individually adjustable blade stabilisation: The blade cannot be accidentally bent or broken

- ▶ Innovative and variably extendable stabilisation bar: versatile, precise, and faster cutting
 - ▶ Exert targeted pressure on the back of the blade without risk of injury, no unintentional bending or breaking of the blade
 - ▶ Robust, durable magnesium housing: as light as plastic, strong as die-cast aluminium
 - ▶ Fixed blade due to high-quality blade locking: Secure fit when cutting, pushing and scraping
- > Handy: 165 mm long, weight approx. 144 g
 - > Original equipment with high quality snap-off blades with two spare blades in the handle drawer which can be changed without any tools
 - > Suitable for standard 18 mm blade types: smooth, curved and with hooks
 - > Fits comfortably in the hand due to its slim shape and numerous grip zones: firm and non-slip grip, comfortable hold
 - > Flat, ergonomic slides separately for blade and stabilisation bar, no accidental activation of the slides
 - > Reliable blade holder: Secure hold of the blade thanks to hardened steel pin
 - > When the rear end of the handle is closed, the blade slider and blade cannot slip out
 - > Tether attachment point for tool protection with KNIPEX Tethered Tools System

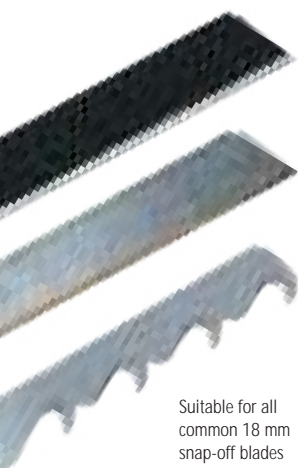
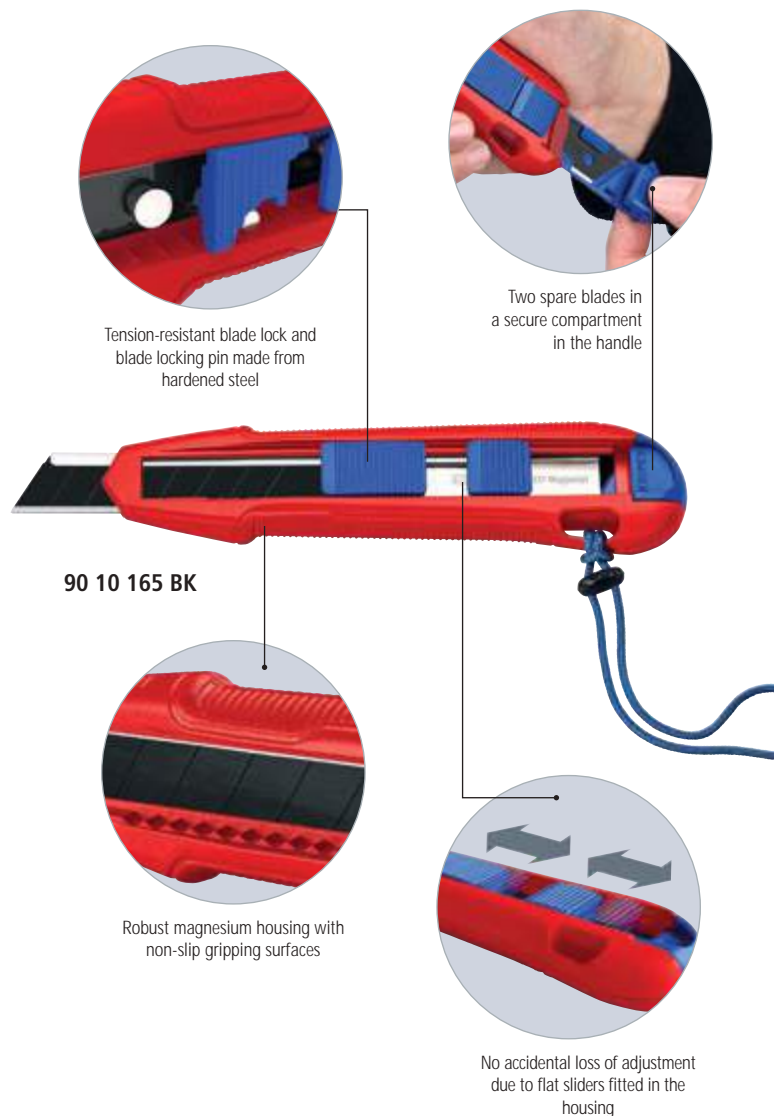

Suitable for all common 18 mm snap-off blades



Quickly sharp again: The blades can be switched without any tools by just one push of the button.



Ergonomic shape with numerous grip zones ensures safe and precise work.



The innovative blade stabilisation allows you to apply more secure pressure directly on the blade.



Variable: Depending on your needs, the blade can be used rigidly or flexibly.

Article no.	EAN 4003773-	↔ mm	⚖ g
90 10 165 BK	087533	165	144
90 10 165 E01	087557	Spare part set for stabilisation bar for 90 10 165 BK	

Anvil Shears

- > Drawing cut against firm surface for cutting soft materials without damage, e.g. rubber profiles, PVC, leather, wood, hoses etc.
- > Cuts flat material with a max. width of 40 mm and height of 7.5 mm
- > Cutting capacity for round material up to Ø 25 mm
- > Strong, replaceable blade
- > With opening spring and locking device
- > Tool body: tool steel, rolled, oil-hardened



94 55 200



Article No.	EAN 4003773-	↔ mm		Tool	Handles	Blade length mm	⚖ g
94 55 200	080763	200	MM	chrome plated	with plastic grips	40	290
94 59 200 01	080916	Spare blade for 94 55 200					

Cutter

for ribbon cable

- > For crush-free cutting of ribbon cable up to 56 mm width
- > Exchangeable cutting base with try square for rectangular cuts
- > With opening spring and locking device
- > Blade: standard trapezoidal blade, replaceable
- > Tool body: tool steel, rolled, oil-hardened



94 15 215

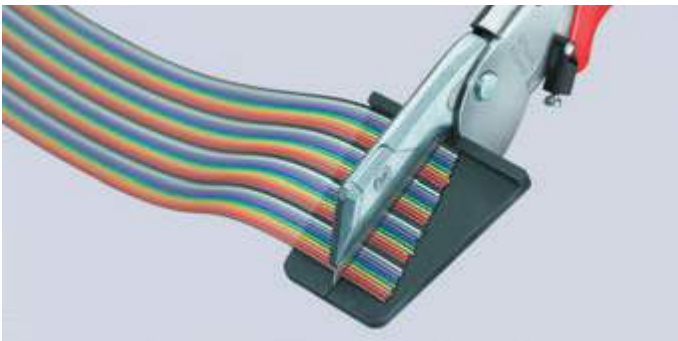

Article No.	EAN 4003773-	↔ mm		Tool	Handles	Blade length mm	⚖ g
94 15 215	046011	215	MM	chrome plated	with plastic grips	56	346
94 19 02	052333	Blade support for 94 15 215					
94 19 215	046219	Set with 10 spare blades for 94 15 215 / 94 35 215					

Mitre Shears

for plastic and rubber sections

- > For crush-free cutting of plastic, rubber and soft timber sections; also for ribbon cable
- > Exchangeable cutting base with try square for 45°-cuts and markings for 60°-, 75°-, and 90°-cuts
- > With opening spring and locking device
- > Blade: standard trapezoidal blade, replaceable
- > Tool body: special tool steel, rolled, oil-hardened



94 35 215

Article No.	EAN 4003773-	↔ mm		Tool	Handles	Blade length mm	⚖ g	
94 35 215	046028	215		chrome plated	with plastic grips	56	397	
94 19 215	046219	Set with 10 spare blades for 94 15 215 / 94 35 215						

Vinyl Shears

also for cable ducts

- > For cutting and shortening cable ducts, also for plastic material
- > Special lever transmission
- > Very effective blade geometry
- > Blade: special tool steel, oil-hardened
- > Tool body: high-grade chrome vanadium electric steel, oil-hardened



95 02 21



Blade length 110 mm for cutting wide cable ducts

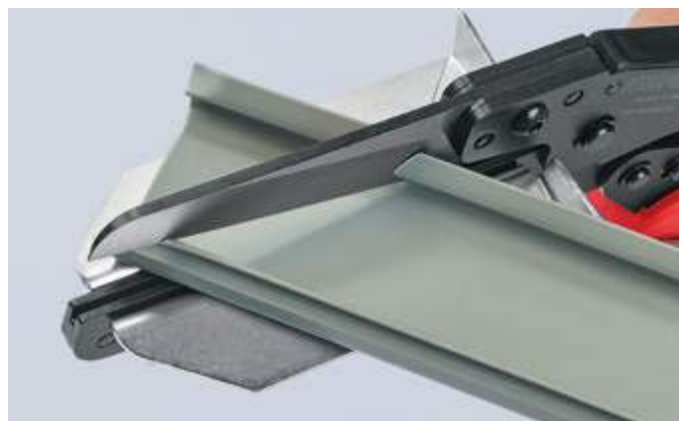

Article No.	EAN 4003773-	↔ mm		Tool	Handles	Cutting capacities mm	Blade length mm	⚖ g
95 02 21	052128	275	 (PATENTED)	burnished	with multi-component grips	max. 4	110	665

Shears

for KEVLAR® fibres

- > Only for cutting fibres of KEVLAR® in optical fibre cables, not recommended for other materials
- > Precisely ground blades with serration prevent the fibres from slipping and guarantee a clean cut
- > Riveted precision joint, for low-friction movement and smooth and even cutting of the thin KEVLAR® fibres
- > Hard-chrome plated, ground surface
- > Shears body: chrome vanadium electric steel, oil-hardened
- > User-friendly handles: plastic, impact-proof



95 03 160 SB



KEVLAR® is a registered trademark of E. I. du Pont de Nemours and Company

Article No.	EAN 4003773-	↔ mm	Shears	Handles	⚖ g
95 03 160 SB	043362	160	chrome plated	plastic coated	85

Combination Shears

- > For cutting cardboard, plastics, aluminium, brass and copper foils
- > Not suitable for steel wire or iron sheets
- > Precision-ground, hardened blades
- > With opening spring and locking device
- > Pinch guard prevents operators' fingers being pinched
- > Adjustable bolted joint
- > Shears body: surgical steel, stainless, vacuum-hardened
- > Handles: plastic, impact-proof

95 05 185

- > Angled shape – for easy execution of long cuttings; ergonomically shaped plastic handles



95 05 140



95 05 185



95 05 190



Article No.	EAN 4003773-	↔ mm		Head	Handles	⚖ g
95 05 140	019589	140	MM	polished	plastic coated	67
95 05 185	060277	185	∠40° MM	polished	plastic coated	115
95 05 190	019602	190	MM	polished	plastic coated	116

Punch Lock Riveters

- > To join metal section sheets used in dry walling for dividing walls and drop ceilings, without needing screws or rivets
- > For U- and C-shaped sections with max 1.2 mm metal (2 x 0.6 mm)
- > Minimum handforce required due to optimum lever transmission
- > Pliers body: special tool steel, rolled, oil-hardened

90 42 250

- > For one-hand operation

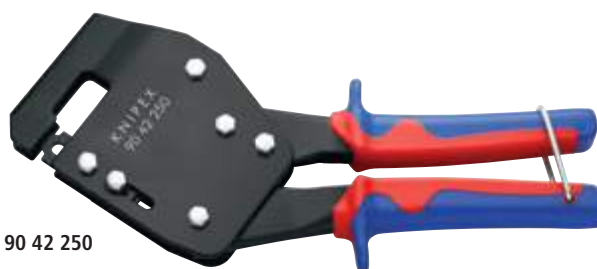

90 42 250



The punching tool is squeezed through the metal section sheets



Setting the pliers for connection of two metal section sheets



90 42 340

Article No.	EAN 4003773-	↔ mm		Pliers	Handles	Capacity	⚖ g
90 42 250	047865	250	MM	burnished	with multi-component grips	max. 1.2 (2 x 0.6)	676
90 42 340	071884	340		burnished	with multi-component grips	max. 1.2 (2 x 0.6)	901
90 49 340	028079	Spare punch for 90 42 340					
90 49 340 M	028499	Spare die for 90 42 340					

Sheet Metal Nibbler

- > For cutting iron, copper or aluminium sheet metal up to max. 1.2 mm thickness, plastic up to max. 2.0 mm thickness
- > Materials are cut without deformation
- > Clean cut edges – no trimming activities needed
- > With chip breaker
- > Easy handling
- > Cutting width: 2.7 mm
- > Blades: special tool steel, oil-hardened, interchangeable
- > Tool body: special tool steel, rolled, oil-hardened

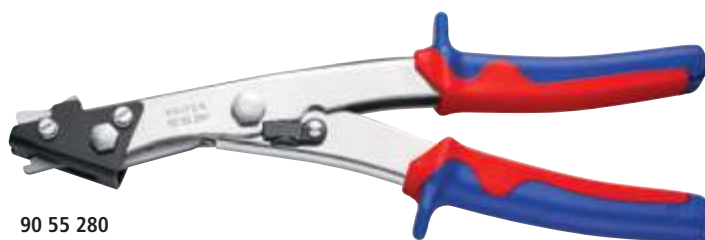

90 55 280



Notching and chip breaking in a single pass



Notching without chip breaking

Article No.	EAN 4003773-	↔ mm		Tool	Handles	⚖ g
90 55 280	026730	280	MM	nickel plated	with multi-component grips	461
90 59 280	027355	Spare blade for 90 55 280				

Notching Pliers

- > Special pliers for notching recesses into plastic ledges and plastic casings for electric and sanitary installation
- > Notches can be enlarged by initial and final cut
- > Clean cut edges – no trimming activities needed
- > Easy handling
- > With opening spring, opening limiter and locking lever
- > Pliers body: special tool steel, rolled, oil-hardened





90 61 16



90 61 20

The KNIPEX Notching Pliers produces the most common notches in plastic ledges and cable ducts in a simple, fast and clean way. No time-consuming sawing out or nibbling and no additional work required.



Article No.	EAN 4003773-	↔ mm		Pliers	Handles	Capacity	⚖ g
90 61 16	051947	250		burnished	with plastic grips	16 x 32 mm	403
90 61 20	051954	250				20 x 29 mm	414

Cycle Pliers

- > For very narrow screw connections
- > Special tool steel, forged, oil-hardened

84 11 200

- > Straight head



84 11 200



84 21 200

Article No.	EAN 4003773-	↔ mm		Pliers	Head	Handles	Recess Ø mm	Head thickness mm	⚖ g
84 11 200	052265	200		black atramentized	polished	plastic coated	10	3.5	180
84 21 200	051930	200		black atramentized	polished	plastic coated	10	3.5	182

Spring Hose Clamp Pliers

- > Rotating, universal grip inserts for reliably gripping the clamps in all positions
- > Jaw inserts can also be rotated under load
- > Extremely good leverage which allows clamps to be opened easily without great effort
- > Slim head design; narrow head width, rotating grip inserts make this an ideal tool, especially in confined areas
- > Additional function: detach hoses gently using the serrated jaw
- > Chrome vanadium electric steel, forged, oil-hardened

85 51 250 AF

- > The locking device enables simple and secure work on clamps under tension without effort



85 51 180 A



85 51 250 A



85 51 250 AF



A single pair of pliers for various sizes of clamps and spring band clamps. Rotating jaw inserts enable them to adapt to any position while still guaranteeing that clamps are securely positioned in the pliers.

APPLICATION AREAS CARS/TRUCKS Air suction, cooling, charge air, water return, thermostat, fuel, heating

The proven features of the KNIPEX Cobra® also apply to the Spring Hose Clamp Pliers

- > Less effort required due to extremely good transmission ratio
- > First class guard to prevent fingers being pinched
- > Reliable gripping with hand-friendly handle position
- > Fine adjustment ensures a precise fit to suit the most diverse clamp sizes
- > Opens at the touch of a button
- > Box-joint design: high stability due to the double guidance

Article No.	EAN	↔ mm	Pliers	Handles	Capacity	Adjustment positions	Δ g
85 51 180 A	081159	180	grey atramentized	with non-slip plastic coating	max. 50 mm	15	190
85 51 250 A	077329	250	grey atramentized	with non-slip plastic coating	max. 70 mm	25	345
85 51 250 AF	078623	250	grey atramentized	with non-slip plastic coating	max. 70 mm	19	350
85 59 250 A	077336	Spare parts assortment grip inserts, for 85 51 250 A / 85 51 250 AF					

Hose Clamp Pliers

for Click clamps

► To open and close Click clamps

- > Rotating jaw inserts for the safe actuation of clamps in any position
- > Good leverage which allows clamps to be opened and closed again comfortably and easily without a great deal of effort
- > For easy working on fuel hoses, vacuum pipes and suction nozzles and many other applications
- > Additional function: detach hoses gently using the serrated jaw
- > Slim head design; narrow head width, rotating grip inserts make this an ideal tool, especially in confined areas
- > Chrome vanadium electric steel, forged, oil-hardened



85 51 180 C



85 51 250 C



Serrated gripping jaws for easy loosening of tight hoses

The proven advantages of the KNIPEX Cobra® also apply to this Hose Clamp Pliers

- > Guard prevents operators' fingers being pinched
- > Reliable gripping with hand-friendly handle position
- > Box-joint design for high stability due to double guide



Article No.	EAN	↔ mm	Pliers	Handles	⚖ g
85 51 180 C	4003773-081166	180	grey atramentized	with non-slip plastic coating	170
85 51 250 C	078517	250			345
85 59 250 C	078999	Spare parts assortment grip inserts, for 85 51 180 C / 85 51 250 C			

Revolving Punch Pliers

- > To punch holes into leather, textiles and plastic material
- > With six interchangeable punches: 2.0 / 2.5 / 3.0 / 3.5 / 4.0 / 5.0 mm dia.
- > With opening spring and locking device
- > Powder-coated for reliable protection against rust
- > Pliers body and punches: special tool steel, oil-hardened



Interchangeable punches



90 70 220



Article No.	EAN 4003773- 019411	↔ mm 220	MM	Pliers red powder-coated	⚖ g 251
90 70 220					

Tile Nibbling Pincer

Parrot Beak Pincer

- > Enlarges holes in tiles and forms tile edges
- > Special tool steel, forged, oil-hardened



91 00 200

Article No.	EAN 4003773- 013754	↔ mm 200	Pliers black atramentized	Head polished	⚖ g 158
91 00 200					

Upholstery Pliers

- > For the professional fixing of seat covers on profiled seats to the seat frame with all popular upholstery clips
- > Securely insert upholstery clips, guide and hold: the special groove fixes the upholstery clips in the correct position
- > Easy positioning of the upholstery clips: a closing spring holds the pliers closed, the clip can be securely positioned and pressed
- > User-friendly operation thanks to multi-component grips
- > Upholstery clips can be easily pressed together due to a good transmission ratio of the pliers
- > Durable and strong
- > Special tool steel, forged, oil-hardened



91 92 180



Article No.	EAN 4003773- 080725	↔ mm 185	Pliers mirror polished	Handles with multi-component grips	⚖ g 195
91 92 180					

Tile Breaking Pliers

Work without cutting-off machine, particularly for fine strips. For less mess, dust, noise and effort.

- ▶ For the precise cutting (breaking) of tiles and porcelain stoneware after scoring with a tile cutter
- ▶ Ideal for long and thick tiles
- > Ideal protection of tiles against damage: replaceable positioning jaw made from soft, stable plastic
- > Great crushing force thanks to 10-fold increase of manual force
- > Easily adjusted to the required tile thickness at the press of a button
- > Chrome vanadium electric steel, forged, oil-hardened



91 13 250



Plastic positioning jaw: tilting for a clean break line and optimum protection of the tiles against damage

Article No.	EAN 4003773-	↔ mm	Pliers	Handles	⚖ g
91 13 250	079538	250	chrome plated	plastic coated	560
91 19 250 01	079545	Spare jaw for 91 13 250			

Material catcher

for 79 02 / 22 125 ESD

- > Material catcher for Electronics Diagonal Cutters: reliably prevents cut material from falling down
- > For particular safety, e.g. in the aerospace industry, in order to avoid FOD (Foreign Object Damage)



00 11 V79

Also suitable for the following pliers:



79 02 125



79 02 125 ESD



79 22 125



79 22 125 ESD



Easy attachment: the material catcher is easily attached and fastens securely to the pliers head



Remove the head of the cable tie using the Electronics Diagonal Cutter...



...the detached workpiece remains safely in the material catcher

Article No.	EAN 4003773-	⚖ g
00 11 V79	083443	20

KNIPEX TwinKey®

PATENTED

for all standard cabinets and shut-off systems

- ▶ 10 profiles. 2 crosses. 1 key.
- ▶ All common locking systems
- > Multifunctional key for the actuation of locking systems from the areas of facilities engineering (heating and sanitation, air conditioning, electro technology), gas and water supply and shut-off-systems
- > 8-arm version: two 4-way spider keys connected in a space-saving way using magnets
- > Reversible bit: 1,0 x 7 mm slot and PH2 cross slot
- > Key and reversible bit joined by stable stainless steel wire
- > Weight-optimised zinc die-cast design



00 11 01



Article No.	EAN 4003773- 074670	↔ mm 92	□ Ø mm 5 / 6 - 7 / 8 - 9 / 10 - 11	△ Ø mm 7 - 8 / 9 - 10 / 11 - 12	○ Ø mm 3 - 5	□ Ø mm 6	▬ Ø mm 6 - 9	⚖ g 135
00 11 01	074670	92	5 / 6 - 7 / 8 - 9 / 10 - 11	7 - 8 / 9 - 10 / 11 - 12	3 - 5	6	6 - 9	135

Control Cabinet Keys

for all standard cabinets and shut-off systems

- > For control cabinets and shut-off systems in the supply of gas, water and electricity
- > For technical installations in buildings, e.g. air conditioning and ventilation systems, shut-off valves, mains switchboards, etc.
- > With bit insert: slot 1.0 x 7 mm and cross recess PH2
- > With adapter for 1/4" bits chained to key
- > Additional bit adapter for 1/4" bits inside one profile
- > Zinc die-casted

00 11 02

- > Short version, total length 44 mm

00 11 03

- > Long execution, total length 76 mm

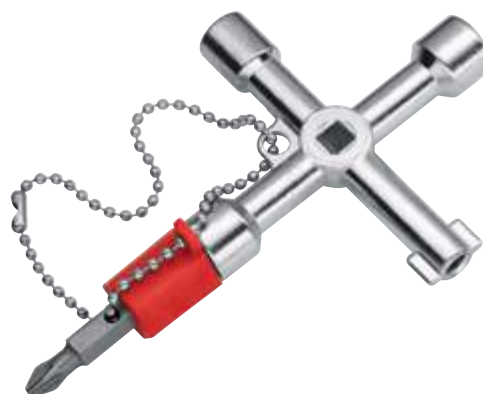

00 11 03

Article No.	EAN 4003773- 048947	↔ mm 44	□ Ø mm 6 / 8	△ Ø mm 9	○ Ø mm 3 - 5	⚖ g 65
00 11 02	048947	44	6 / 8	9	3 - 5	65
00 11 03	041658	76	5 / 6 / 8	7 / 9	3 - 5	88





Profi-Key

for all standard shut-off systems

- > Key for heating, air conditioning, sanitary and building technology, e.g. for door and window handles or for radiator-bleeding
- > With bit insert: slot 1.0 x 7 mm and cross recess PH2
- > With adapter for 1/4" bits chained to key
- > Additional bit adapter for 1/4" bits inside one profile
- > Total length: 90 mm
- > Zinc die-casted



00 11 04

Article No.	EAN 4003773-	↔ mm	 Ø mm	 Ø mm	 Ø mm	 g
00 11 04	048954	90	5 / 7 / 8	9 – 10	6 / 7 / 8 / 9 / 10	86



Universal Key

for all standard cabinets and shut-off systems

- > For locking systems in electrical engineering, the supply of gas and water, air conditioning and ventilation systems, industry, technical installations in buildings, etc.
- > 9 different die-cast zinc key-profiles in 1 tool
- > With detachable chain and snap hook
- > Total length: 90 mm
- > Zinc die-casted



00 11 06

Article No.	EAN 4003773-	↔ mm	 Ø mm	 Ø mm	 Ø mm	 Ø mm	 g
00 11 06	071334	90	5 / 6 / 7 – 8 / 9 – 10	7 / 8 – 9 / 10 – 11	3 – 5	6	220

Universal Key "Construction"

for all standard cabinets and shut-off systems

- > For locking systems in electrical engineering, the supply of gas and water, air conditioning and ventilation systems, industry, technical installations in buildings, etc.
- > 9 different die-cast zinc key-profiles in 1 tool
- > With detachable chain and snap hook
- > Construction version with plug-in, magnetically held support: catch for locks with profile cylinder hole and male square in steps
- > With bit adapter for 1/4" bits with magnet
- > Total length: 157 / 95 mm
- > Zinc die-casted



00 11 06 V01

Article No.	EAN 4003773-	↔ mm	 Ø mm	 Ø mm	 Ø mm	 Ø mm	 g
00 11 06 V01	075394	90	5 / 6 / 7 – 8 / 9 – 10	7 / 8 – 9 / 10 – 11	3 – 5	6	255





Control Cabinet Key "DoubleJoint"

- > For locking systems in electrical engineering, the supply of gas and water, air conditioning and ventilation systems, industry, technical installations in buildings, etc.
- > With bit adapter for 1/4" bits with magnet
- > Four different zinc die-cast key profiles in a single key
- > Total length: 97 mm
- > Plastic body, varnished

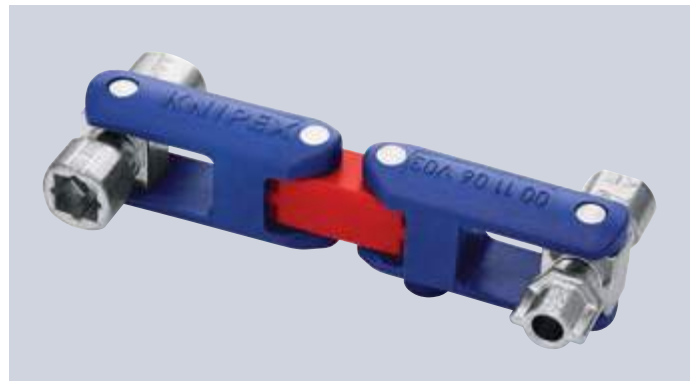

00 11 06 V03



Article No.	EAN 4003773-	↔ mm	 Ø mm	 Ø mm	 Ø mm	 g
00 11 06 V03	083085	62	5 - 8	5 / 7 - 9	3 - 5	107

Pen-Style Control Cabinet Key



for all standard cabinets and shut-off systems

- > Easy to carry pen-style control cabinet key with fastening clip
- > Four different key profiles can be utilised by swivelling the key holder
- > For control cabinets and shut-off systems in the supply of gas, water and electricity
- > For technical installations in buildings, e.g. air conditioning and ventilation systems, shut-off valves, mains switchboards, etc.
- > Universal 1/4" bit adapter for standard bits (permanent magnet for retaining)
- > Additional bit adapter for 1/4" bits inside one key profile
- > With 2 reversible bits: cross recess PH / slot 7.0 x 1.2 mm and TX20 / TX25
- > Tool body: plastic, fibreglass-reinforced
- > Key profiles: zinc die-casted



00 11 07



Article No.	EAN 4003773-	↔ mm	 Ø mm	 Ø mm	 Ø mm	 g
00 11 07	063018	145	5 / 6 / 8	9	3 - 5	95

Cable and Wire Rope Shears



KNIPLEX StepCut® – Cable Shears	153
Cable Shears	154, 157
Cable Shears with twin cutting edge	155
Wire Rope Cutters	156
Electricians' Shears	157
Angled Electricians' Shears	158
ACSR Cable Cutter (ratchet action)	159
Cable Cutters (ratchet action)	160
Cable Cutters (ratchet principle, 3-stage)	161
Cable Shears (ratchet action)	163
Wire Rope Cutters	164
Bowden Cable Cutter	164
Wire Rope and ACSR-Cable Cutters	165

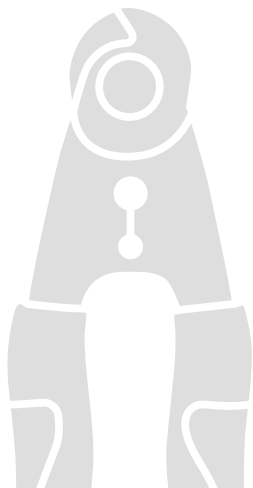

KNIPEX StepCut®

Additionally hardened blades, precision-ground:
lighter, cleaner cut without crushing



KNIPEX StepCut®

Cable cutting made easy: innovative step cutting separates wires one by one to save energy

- ▶ Small, light, strong: comfortable cutting without crushing and just 160 mm in size
 - ▶ Noticeably less effort: the gradations cut wires one after the other; cutting is up to 40% easier than with standard cable shears of the same length!
 - ▶ Ergonomic handle design: optimal cutting feel even for larger cable diameters
- > Cuts multi-core stranded copper and aluminium cables up to Ø 15 mm (50 mm²)
 - > Cuts solid copper and aluminium cables up to 5 x 4 mm²
 - > Cuts without crushing
 - > Bolted joint: precise, effortless, durable
 - > Pinch guard fitted for safe work
 - > Not suitable for steel wire and hard drawn copper conductors
 - > Long lifetime: high-grade special tool steel, forged, oil-hardened, cutting additionally induction-hardened



95 11 160



95 12 160

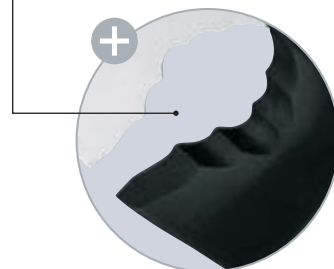

95 16 160



Article No.	EAN 4003773-	↔ mm	Tool	Handles	Cutting capacities				
					⊕ Ø mm	⊕ mm ²	AWG	⚖ g	
95 11 160	085904	165	burnished	plastic coated	15.0	50	1 / 0	180	
95 11 160 SB	085911	165	burnished	plastic coated	15.0	50	1 / 0	205	
95 12 160	085928	165	burnished	with multi-component grips	15.0	50	1 / 0	220	
95 12 160 SB	085935	165	burnished	with multi-component grips	15.0	50	1 / 0	245	
95 16 160	085966	165	⚡ 1000 V ⚡	chrome plated	insulated with multi-component grips, VDE-tested	15.0	50	1 / 0	225
95 16 160 SB	085898	165	⚡ 1000 V ⚡	chrome plated	insulated with multi-component grips, VDE-tested	15.0	50	1 / 0	250

Cable Shears

- > For cutting copper and aluminium single conductors as well as multiple stranded cables
- > Clean and smooth cut without crushing and deformation
- > Not suitable for steel wire and hard drawn copper conductors
- > Precision-ground, hardened blades
- > Easy cutting with one-hand operation
- > With guard
- > Adjustable bolted joint, self-retaining screw
- > High-grade special tool steel, forged, oil-hardened

Style 2

- > Internal opening spring, protected and captive

Style 4

- > Multifunctional tool for working on NYM cable from 3 x 1.5 mm² to 5 x 2.5 mm² (cutting and stripping); universal stripping area for both solid conductor cross-sections; reliable alignment of the cable in the stripping area due to V-shaped blade geometry

95 12 165 T / 95 16 165 T*

- > Pliers with tether attachment point for mounting a fall protection



95 11 165



95 12 165



95 12 165 T



95 16 165



95 21 165



95 22 165



Cut performed with a Cable Shear: easy, clean cut without any deformation of the cable



95 26 165: Catch locks shears to the opening spring inside



95 41 165: with stripping function

Article No.	EAN 4003773-	↔ mm		Style	Tool	Handles	Cutting capacities			⚖ g
							∅ mm	mm ²	AWG	
95 11 165	040323	165		1	burnished	plastic coated	15	50	1 / 0	215
95 12 165	029182	165		1	burnished	with multi-component grips	15	50	1 / 0	250
95 12 165 T	080190	165		1	burnished	with multi-component grips and integrated tether attachment point	15	50	1 / 0	255
95 16 165	039648	165	⚡ 1000V	1	chrome plated	insulated with multi-component grips, VDE-tested	15	50	1 / 0	262
95 16 165 T	081524	165	⚡ 1000V	1	chrome plated	insulated with multi-component grips with integrated insulated tether attachment point, VDE tested	15	50	1 / 0	260
95 21 165	069805	165	⚡	2	burnished	plastic coated	15	50	1 / 0	215
95 22 165	069812	165	⚡	2	burnished	with multi-component grips	15	50	1 / 0	254
95 26 165	069980	165	⚡ 1000V	2	chrome plated	insulated with multi-component grips, VDE-tested	15	50	1 / 0	275
95 41 165	078609	165	⚡	4	burnished	plastic coated	12	35	1 / 0	220

Cable Shears

with twin cutting edge

- > For cutting copper and aluminium cables
- > Not suitable for steel wire and hard drawn copper conductors
- > Precision-ground, hardened blades
- > Clean and smooth cut without crushing and deformation
- > By dividing the cutting actions into initial cut (insulating sheath in the front cutting area) and final cut (conductor in the back cutting area), cables up to Ø 20 mm can be cut in one-hand operation
- > Low handforce required due to favourable lever ratio and special blade geometry
- > Pinch guard prevents operators' fingers being pinched
- > Adjustable bolted joint, self-retaining screw
- > High-grade special tool steel, forged, oil-hardened



Initial cut: using the front cutting edge to cut the insulating sheath on larger cable diameters leaves an ergonomic handle opening width.



Final cut: after cutting the sheath in the front profile the conductors in the rear part are cut. Initial cut in the front profile, final cut in the rear profile - to keep it as easy as possible.



95 11 200



95 12 200



95 16 200



95 17 200

The twin cutting edge allows a comfortable handle position in all cutting situations within the specified cutting capacity.

Article No.	EAN 4003773-	↔ mm		Tool	Handles	Cutting capacities			
						Ø mm	mm ²	AWG	Δg
95 11 200	043928	200	(PATENTED)	burnished	plastic coated	20	70	2 / 0	283
95 12 200	047834	200	(PATENTED)	burnished	with multi-component grips	20	70	2 / 0	324
95 16 200	026761	200	⚡ 1000V ⚡	chrome plated	insulated with multi-component grips, VDE-tested	20	70	2 / 0	340
95 17 200	026952	200	⚡ 1000V ⚡	chrome plated	with dipped insulation, VDE-tested	20	70	2 / 0	360

Wire Rope Cutters

also for high-strength wire rope

- > Compact, light and powerful
- > Up to 30% less physical effort compared to wire rope cutters of the same length
- > Double-mounted box joint design for high level of stability
- > Cutting edges additionally induction-hardened, cutting edge hardness approx. 64 HRC
- > Convenient work thanks to opening spring
- > Secured by locking device during transport
- > Ball bearing steel

95 62 160

> For wire rope with \varnothing 4.00 / 1960 Nmm²

95 62 160 TC

> Specially optimised for precise cutting of tyre cord, wire ropes up to \varnothing 2 mm and cables up to \varnothing 2 mm; Ergonomic efficiency thanks to lightweight design and practical opening restriction



95 62 160



95 62 160 TC



Double-bearing joint



For cutting high-strength wire ropes (1960 N/mm²) with a diameter of up to 4 mm



Compact at 160 mm but nevertheless more powerful than many larger wire rope cutters



95 62 160



95 62 160 TC

Article No.	EAN 4003773-	↔ mm	Head	Handles	Cutting capacities		⚖ g
					⊕ Ø mm	⊗ mm ²	
95 62 160	082354	160	burnished	with multi-component grips	6.0	4.0	175
95 62 160 TC	082422	160	burnished	with multi-component grips	2.0	2.0	175

Cable Shears

handles extrusion plastic-coated

- > Not suitable for steel wire and hard drawn copper conductors
- > Precision-ground, hardened blades
- > No crushing, slight deformation of the cable only
- > Pinch guard prevents operators' fingers being pinched
- > Adjustable bolted joint
- > Shears body: surgical steel, stainless, vacuum-hardened
- > Handles: plastic, impact-proof

95 05 165

- > Cuts cables up to 10 mm dia. / 24 mm²; with opening spring and locking device; blades made of stainless steel; oil-hardened and tempered



95 05 165

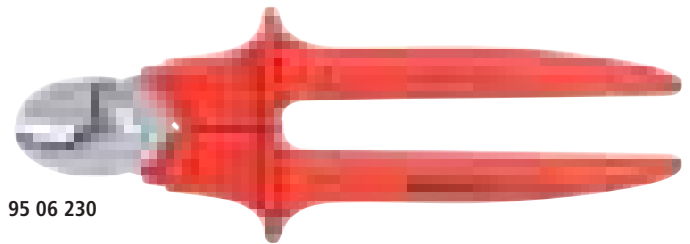

95 06 230

95 06 230

- > For copper single conductors up to 16 mm², multiple stranded wires up to 50 mm², fine stranded up to 70 mm² and aluminium conductors multiple stranded wires up to 70 mm²; easy cutting with one-hand operation due to high transmission ratio; stainless – special grade – steel, oil-hardened and tempered

Article No.	EAN 4003773-	↔ mm	Head	Handles	Cutting capacities			⚖ g
					⊘ mm	mm ²	AWG	
95 05 165	019596	165	polished	plastic coated	10	24	4	111
95 06 230	006305	230	polished	plastic insulated, VDE-tested	16	50	1 / 0	274

Electricians' Shears

- ▶ Precisely ground blades with fine serration for a clean, non-slip cut
- ▶ Cutting edge with integrated cable cutter
- ▶ With plastic belt pouch

- > Universal shears for electricians
- > Handles with multi-component grips, fibreglass-reinforced
- > Cutting edges made from stainless steel, hardness of cutting edges 56 HRC



95 05 10 SB



95 05 155 SB

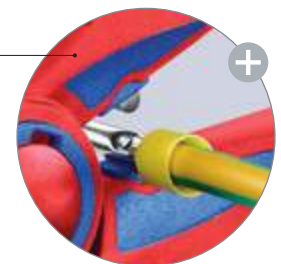

Fast, easy crimping



No slipping thanks to micro-serration



Integrated cable cutter



Safely stored and ready to hand at all times

Article No.	EAN 4003773-	↔ mm	⚖ g
95 05 10 SB	082125	160	135
95 05 155 SB	077725	155	170

Angled Electricians' Shears

Universal shears with straight hand positioning for improved ergonomics

- ▶ Precision-ground blades with fine serrations for a clean, non-slip cut
- ▶ Adapted to the hand: angled blades and optimised handle design for improved ergonomics
- > Two crimping areas for wire ferrules of 0.5 – 6 mm² and 10 – 25 mm²
- > Includes opening spring and lock for easy storage
- > Tether attachment point can be used with KNIPEX Tethered Tools System
- > Cutting edges made from stainless steel, hardness of cutting edges 56 HRC



With fine serration for precise cutting ...



and two crimping areas for standard wire ferrules sizes



Practical belt pouch available separately

Article no.	EAN	↔ mm	Head	Handles	⚖ g
95 05 20 SB	4003773-082699	160	polished	with mult-component grips, glass fibre reinforced	190
00 19 75 LE	088158	Multi-purpose belt pouch			70

Cable Shears

for two-handed use, short construction

- ▶ Short design, length only 500 mm
- ▶ Low weight, high leverage
- > For cutting copper and aluminium single conductors as well as multiple stranded cables
- > Not suitable for steel wire and wire ropes
- > Precision-ground, hardened blades
- > Clean and smooth cut without crushing and deformation
- > Low handforce required due to favourable lever ratio and special blade geometry
- > Pinch guard prevents operators' fingers being pinched
- > Adjustable bolted joint
- > Cutter head: vanadium electric steel, forged, oil-hardened
- > Handles: aluminium tube, high-strength

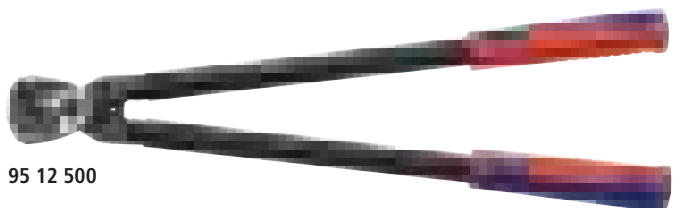

95 12 500



95 17 500



Large cutting capacity: max. 27 mm dia. / 150 mm²

Article No.	EAN	↔ mm	Head	Handles	Cutting capacities			⚖ g
					Ø mm	mm ²	AWG	
95 12 500	069966	500	burnished	with multi-component grips	27	150	6 / 0	1090
95 17 500	026785	500	⚡ 1000V ⚡	with dipped insulation, VDE-tested	27	150	6 / 0	1477

Cable Shears

for two-hand operation

- > For cutting copper and aluminium single conductors as well as multiple stranded cables
- > Not suitable for steel wire and wire ropes
- > Precision-ground, hardened blades
- > Clean and smooth cut without crushing and deformation
- > Favourable lever ratio due to toggle lever
- > Pinch guard prevents operators' fingers being pinched
- > Adjustable bolted joint
- > Bolted cutter head, replaceable
- > Handles: steel tube
- > Cutter head: high-grade chrome vanadium electric steel, forged, oil-hardened



95 21 600



95 27 600

Article No.	EAN 4003773-	↔ mm	Head	Handles	Cutting capacities			⚖ g
					⊘ mm	mm ²	AWG	
95 21 600	025252	600	polished	with plastic grips	27	150	6 / 0	1862
95 27 600	021797	600	⚠ 1000V  polished	with dipped insulation, VDE-tested	27	150	6 / 0	2262
95 29 600	021803	Spare cutter head for 95 21 600 / 95 27 600						

ACSR Cable Cutter

(ratchet action)

for cables with a steel core

- ▶ Handy. Compact. Sturdy.
- ▶ Extremely robust design.

- > Cuts through aluminium conductor cable with steel core up to a diameter of 32 mm in one or two-handed operation
- > Cutters with precision cut and induction-hardened cutting edge
- > Two-stage ratchet drive for easy cutting
- > Less physical effort due to very high transmission ratio
- > Fixed handle with support area for putting down the pliers when cutting
- > Locking mechanism for transporting with safely closed handles
- > Special high grade tool steel, multi stage oil-hardened



95 32 340 SR



Enormous power with a weight of just 1300 g



The strong "flange" on the handle can be used as a practical support surface when cutting larger diameters

Article No.	EAN 4003773-	↔ mm	Head	Handles	Cutting capacities			⚖ g
					⊘ mm	⊘ inch	MCM	
95 32 340 SR	081241	340		with multi-component grips	32	1	477	1310
95 39 340 01	081340	Pivot cutter repair kit for 95 32 340 SR						

Cable Cutters

(ratchet action)

- > For cutting copper and aluminium single conductors as well as multiple stranded cables
- > Not suitable for steel wire and wire ropes
- > Precision-ground, hardened blades
- > Clean and smooth cut without crushing and deformation
- > One-hand operation using ratchet principle
- > Little handforce required due to very high transmission ratio
- > Two-stage ratchet drive for easy cutting
- > Simple handling as a result of low weight and compact design – can be used even in confined areas
- > Pinch guard prevents operators' fingers being pinched
- > High-grade special tool steel, forged, oil-hardened

95 31 280 / 95 36 280

- > Suitable for aluminium sector cable up to 4 x 150 mm²

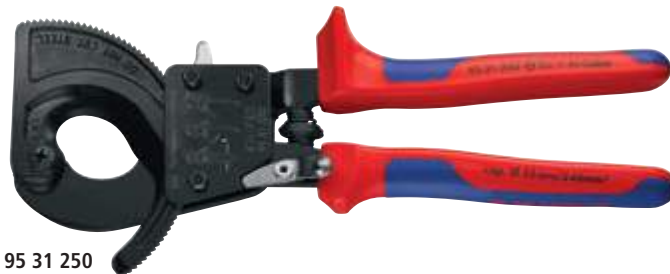

95 31 250



95 31 280



95 36 250

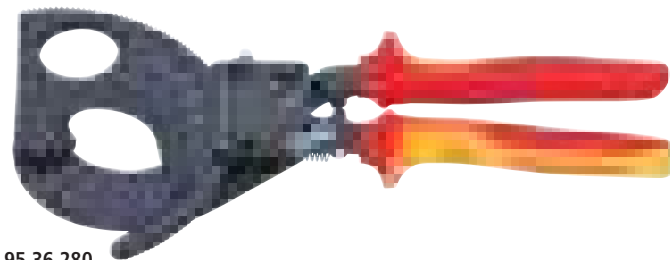

95 36 280



Ratchet principle and two-stage ratchet drive for easier cutting



95 31 280: Large cutting capacity: maximum 52 mm dia. / 380 mm²



95 31 250/280: fixed handle with support area as an aid to position the cutters on a flat surface

Article No.	EAN 4003773-	↔ mm	Blade	Tool	Handles	Cutting capacities		MCM	⚖ g
						⊘ mm	mm ²		
95 31 250	043935	250	MM	black lacquered	with multi-component grips	32	240	500	676
95 31 280	043942	280	MM	black lacquered	with multi-component grips	52	380	750	860
95 36 250	026884	250	⚡ 1000 V ⚡ MCM MM	black lacquered	insulated with multi-component grips, VDE-tested	32	240	500	652
95 36 280	026891	280	⚡ 1000 V ⚡ MCM MM	black lacquered	insulated with multi-component grips, VDE-tested	52	380	750	835
95 39 04	039167	Feed pawl 95 3 250/280							
95 39 250	022244	Movable spare blade for 95 31 250 / 95 36 250							
95 39 08	039204	Barrel spring for 95 31 250/280							
95 39 280	025283	Movable spare blade for 95 31 280 / 95 36 280							
95 39 08 S	039211	Tension spring set for lateral mounting 95 36 25/28							

Cable Cutters

(ratchet principle, 3-stage)

- ▶ Sturdy. Easy to use. Stable.
 - ▶ Innovative ratchet-drive.
 - ▶ For cable up to 60 mm diameter.
- > Fixed handle with support area for putting down the pliers when cutting
 - > Easy handling due to low weight (825 g) and compact construction (320 mm length) – also usable in confined areas
 - > Cutting through copper and aluminium cables with diameters of up to 60 mm in one-hand and two-hand operation
 - > Hardened cutting edges, precisely ground, cut smoothly and neatly without crushing
 - > For cutting copper and aluminium single conductors as well as multiple stranded cables (not suitable for steel wire and wire ropes)
 - > Innovative three-stage ratchet-drive with high leverage for easy cutting in one-hand and two-hand operation
 - > High-grade special tool steel, forged, oil-hardened



95 32 320



95 36 320

The innovative three gear drive permits three operating modes

- > Fast working with full lift of handles and one-handed operation when cutting through insulation material
- > Powerfully sliding the sickle knife forward when cutting through the stranded conductor with two hand through use of the central lifting area (handling opening of between 1/3 and 2/3)
- > Powerfully pushing the sickle knife forward with one hand to cut through the stranded conductor through use of the first third of the handle lift with one or two hands

First manual ratchet-action cable cutter for one-hand and two-hand operation for cutting copper and aluminium cables with diameters of up to 60 mm!



Article No.	EAN 4003773-	↔ mm		Tool	Head	Handles	Cutting capacities			Δg
							Ø mm	mm ²	MCM	
95 32 320	075172	320	AWW	black atramentized	polished	with multi-component grips	60	600	1200	825
95 36 320	075189	320	▲ 1000 V AWW	black atramentized	polished	insulated with multi-component grips, VDE-tested	60	600	1200	830
95 39 320 01	075714	Pivot cutter repair kit for 95 32 320 and 95 36 320								
95 39 320 02	075721	Fixed cutter repair kit for 95 32 320 and 95 36 320								

Cable Cutters

(ratchet action)

for steel wire armoured cables (SWA cable)

- ▶ Cuts through steel wire armoured cables with a diameter of up to 45 mm / 380 mm² (e.g. 4 x 95 mm²) using one or two-handed operation
- ▶ Sturdy. Easy to use. Stable.
- > Simple handling due to low weight (800 g) and compact design (315 mm length) – can also be used in confined areas
- > Precision-ground blades and induction-hardened cutting edges cut smoothly and neatly without crushing
- > Innovative high leverage three-stage ratchet-drive
- > Support area for putting down the pliers when cutting
- > Not suitable for cutting ACSR cable and wire rope!
- > Cutter head: special high-grade tool steel, forged, oil-hardened



95 32 315 A



95 36 315 A

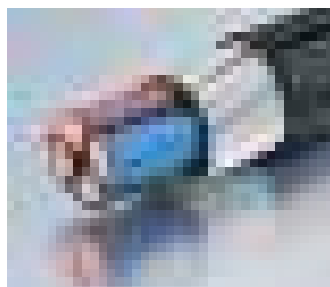

Precision-milled and induction-hardened cutting edge

Article No.	EAN 4003773-	↔ mm	Tool	Handles	Cutting capacities			⚖ g	
					Ø mm	mm ²	MCM		
95 32 315 A	078562	315	MM	black lacquered	with multi-component grips	45	380	750	800
95 36 315 A	078579	315	⚠ 1000 V ⚡ MM	black lacquered	insulated with multi-component grips, VDE-tested	45	380	750	800
95 39 315 A01	078586	Pivot cutter repair kit for 95 32 315 A and 95 36 315 A							

Cable Shears

(ratchet action)

with telescopic handles

▶ Cable shears with adjustable telescopic handles allowing angular positioning

- > For cable diameters up to 38 mm, handles can be positioned at an angle to set the optimum handle width, which makes the shear also suitable for work in confined areas
- > Comfortable work thanks to ratchet action and low weight
- > Heavy duty telescopic handles made of oval aluminium tubing; extendable up to 770 mm for maximum leverage on large cable diameters; retractable down to 570 mm for minimum space requirements during transport
- > Replaceable cutting head
- > Extensive cutting range up to max. Ø 38 mm or max. 280 mm² (e.g. 4 x 70 mm² NYY) in copper and aluminium cables
- > Easier, neater cut due to optimised cutting edge geometry
- > Adjustable bolted joint
- > Handles: high-strength oval aluminium tubing
- > Cutting head: special quality high-grade tool steel, oil-hardened

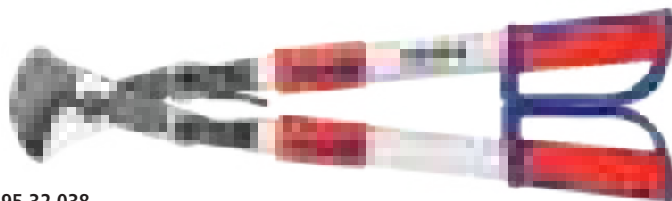

95 32 038



Handles adjustable in length and angular position for easier work: set the handle length to the optimum lever for powerful cutting; put the handles at an angle for a comfortable gripping position

Article No.	EAN 4003773-	↔ mm	Head	Handles	Cutting capacities			⚖ g
					Ø mm	mm ²	MCM	
95 32 038	071556	570	burnished	with multi-component grips	38	280	550	1980
95 39 038	073260	Spare cutter head for 95 32 038						

Cable Cutters

(ratchet action)

with telescopic handles

- > For copper and aluminium single conductors as well as multiple stranded cables – also with hard rubber or plastic sheath
- > Not suitable for steel wire and wire ropes
- > Also suitable for cables with iron sheath reinforcement
- > Little hand force required for cutting due to optimum transmission ratio
- > High cutting capacity due to two-hand operation and ratchet action
- > The blade can be opened in any cutting position
- > Handle length with multiple position adjustment from 400 - 610 mm (short transport length, individual adaptation to working conditions)
- > Blade: special-quality high-grade tool steel, oil-hardened
- > Handles: high-strength oval aluminium tubing

95 32 100

> Tool length: 650 - 860 mm; weight only 4980 g

95 32 060

> Tool in length: 630 to 830 mm; weight only approx. 3820 g

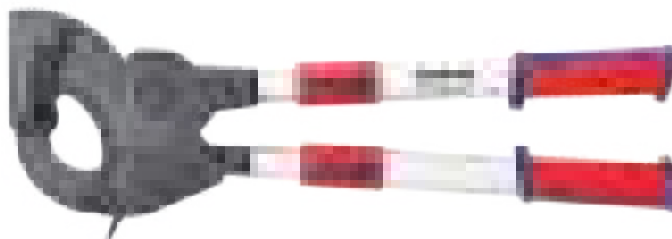

95 32 060



Article No.	EAN 4003773-	↔ mm	Head	Handles	Cutting capacities			⚖ g
					Ø mm	mm ²	MCM	
95 32 060	071563	630	burnished	with multi-component grips	60	740	1400	3820
95 32 100	071570	680			100	960	1900	4980
95 39 720	025290	Movable spare blade for 95 31 720 / 95 32 060						
95 39 870	025306	Movable spare blade for 95 31 870 / 95 32 100						

Wire Rope Cutters

forged

Double function: neat cutting, precise crimping

- > With two crimping dies for end caps on Bowden cable sheaths and end ferrules for traction cables
- > Comfortable work thanks to handy, slim design and internal opening spring
- > Bolted joint for precise blade guidance, re-adjustable
- > High leverage for reduced effort
- > Cutting edge hardness approx. 64 HRC
- > Chrome vanadium heavy-duty steel, forged, multi stage oil-hardened

95 62 190 T*

- > Pliers with tether attachment point for mounting a fall protection



95 61 190



95 62 190



95 62 190 T

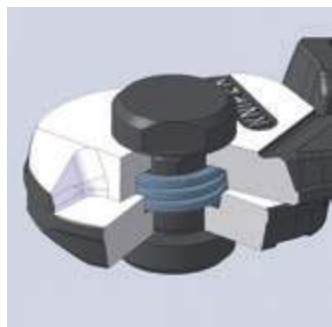

Internal opening spring



Crimping of the end caps on the Bowden cable sheath

Cuts all wire ropes without splaying, including those that are extremely strong

Article No.	EAN 4003773-	↔ mm		Head	Handles	Cutting capacities				⚖ g
						⊙ mm	⊙ mm	◐ mm	● mm	
95 61 190	040651	190	MM	polished	plastic coated	7.0	5.0	4.0	2.5	310
95 62 190	071976	190	MM	burnished	with multi-component grips	7.0	5.0	4.0	2.5	314
95 62 190 T	080206	190	MM	burnished	with multi-component grips and integrated tether attachment point	7.0	5.0	4.0	2.5	345

Bowden Cable Cutter

- > For Bowden cables and soft wire rope up to 3.0 mm dia. (also V2A)
- > Smooth and clean cutting due to special shape of the cutting edges
- > Sickle shape cutting edges surround the material and prevent the wire rope fanning out
- > Little handforce required due to very high transmission ratio
- > With opening spring and locking device
- > Chrome vanadium heavy-duty steel, forged, multi stage oil-hardened



95 61 150



Article No.	EAN 4003773-	↔ mm		Shears	Head	Handles	Cutting capacities	⚖ g
							⊙ mm	
95 61 150	065197	150	MM	black atramentized	polished	plastic coated	3.0	205

*Other tools with tethering can be found from page 272

Wire Rope and ACSR-Cable Cutters

Handles: aluminium, high-strength

- > For wire ropes and steel rods, copper and aluminium cables
- > Suitable for cutting overhead cables with strain relief wire (ACSR-cables)
- > Angular cutting blades allow cutting of single rope wire
- > Optimum transmission ratio for high cutting performance
- > Bolted cutter head, replaceable
- > Low weight
- > Handles: aluminium, high-strength
- > Cutter head: high-grade special tool steel, multi stage oil-hardened

95 81 600

- > With reinforced cutter head for higher performance, also cuts piano wire



95 71 445



95 71 600



95 77 600



95 81 600

Article No.	EAN 4003773-	↔ mm		Head	Handles	Cutting capacities				AWG	⚖ g
						⊗ mm ²	⊙ Ø mm	◐ Ø mm	● Ø mm		
95 71 445	014522	445		polished	plastic coated	95	10,0	7,0		4 / 0	1083
95 71 600	014539	600		polished	plastic coated	150	14,0	9,0		6 / 0	1716
95 77 600	025313	600	⚡ 1000V ⚠	polished	dipped insulation	150	14,0	9,0		6 / 0	2359
95 81 600	025344	600		polished	plastic coated	150	16,0	10,0	4,5	6 / 0	2256
95 79 445	025320	Spare cutter head for 95 71 445									
95 79 600	025337	Spare cutter head for 95 71 600 / 95 77 600									
95 89 600	025351	Spare cutter head for 95 81 600									

Crimping Pliers and Crimp Assortments



Crimping Pliers	168
Insertion tool	169
KNIPEX MultiCrimp – Crimping Pliers with changer magazine	170
Crimp System Pliers	172
KNIPEX eCrimp – Electromechanical Crimp System Pliers	173
Crimping Dies	174
Tool Case for Photovoltaics	176
Set of Mounting Tools	177
Compression Tool for coax connectors	177
Crimping Pliers for Scotchlok™ connectors	177
Crimping Pliers for Western plugs	178
Crimping Pliers for RJ45 Western plugs	179
Crimping Pliers short design	179
Crimping Pliers also for two-hand operation	180
KNIPEX PreciForce – Crimping Pliers	181
Four-Mandrel Crimping Pliers for turned contacts	182
Self-Adjusting Crimping Pliers for wire ferrules with lateral access	184
Automatic Crimping Pliers for Wire Ferrules	185
KNIPEX Twistor® 16 – Self-Adjusting Crimping Pliers for wire ferrules	186
Self-Adjusting Crimping Pliers for wire ferrules with front loading	187
Crimping Pliers for micro plugs	188
Crimping Pliers for wire ferrules	188
Crimp Assortments	190
Cable Connectors	192
Assortment Boxes	196
F-compression connector	197

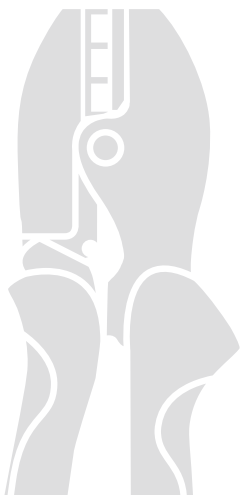

Crimping Pliers

- > For cutting cables, stripping wire and crimping insulated and non-insulated terminals, connectors and plug type connectors
- > With threaded holes for cutting copper and brass screws threaded M 2.6 / M 3 / M 3.5 / M 4 and M 5
- > Bolted joint for higher stability and even movement
- > Special steel, high-strength

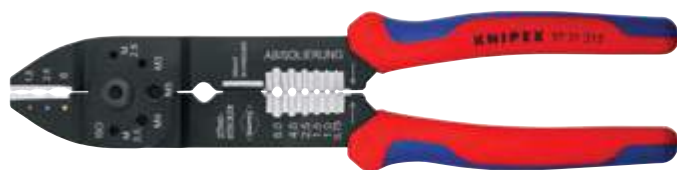

97 21 215

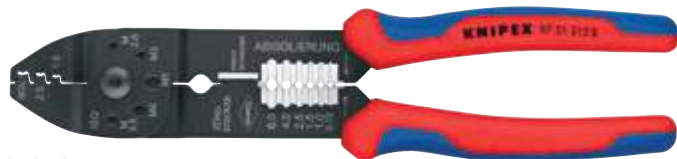

97 21 215 B

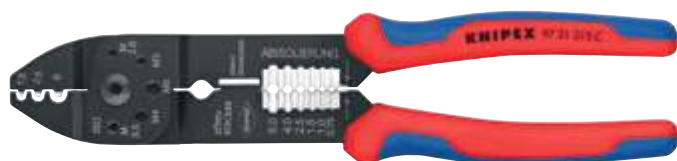

97 21 215 C

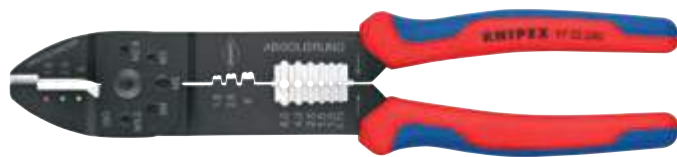

97 22 240

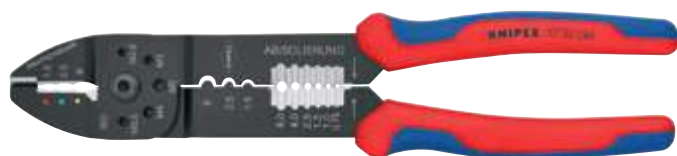

97 32 240

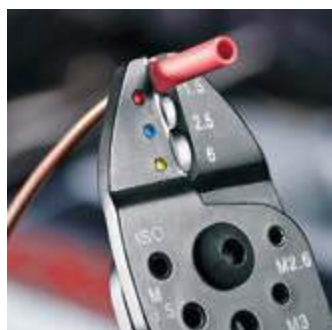

Article No.	EAN 4003773-	↔ mm			Pliers	Handles	Applications	Capacity mm ²	AWG	Δ g
97 21 215	019688	230			black lacquered	with multi-component grips	insulated terminals + cable connectors	0.5 - 6	20 - 10	290
97 21 215 B	019695	230			black lacquered	with multi-component grips	non-insulated open plug-type connectors (plug width 6.3 mm)	0.5 - 2.5	20 - 14	290
97 21 215 C	019701	230			black lacquered	with multi-component grips	non-insulated terminals + cable connectors	0.5 - 6	20 - 10	290
97 22 240	070726	240			black lacquered	with multi-component grips	insulated terminals + cable connectors/ non-insulated open plug-type connectors (plug width 6.3 mm)	0.5 - 6	20 - 10	270
							non-insulated open plug-type connectors (plug width 6.3 mm)			
97 32 240	079491	240			black lacquered	with multi-component grips	insulated terminals + cable connectors/ non-insulated terminals + cable connectors	0.5 - 6	20 - 10	300
							non-insulated terminals + cable connectors			

Insertion tool

for LSA-Plus and identical construction design

- > Tool for putting on boards, sockets and fields
- > Pushing down and cutting in one operation
- > For UTP and STP cables, conductor 0.4 - 0.8 mm dia.
- > With integrated pulling hook and release blade
- > Housing: plastic, impact-proof



97 40 10



With integrated pulling hook



Inserts and cuts cables in one operation

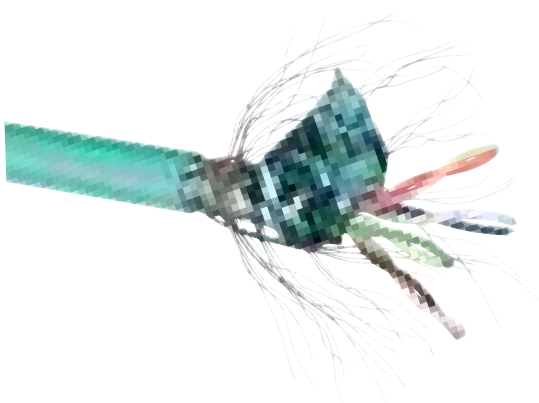

Article No.	EAN	↔ mm	Head	Applications	Capacity Ø mm	⚖ g
97 40 10	4003773-044895	175	burnished	UTP- and STP-cables, LSA-Plus and identical	0.4 - 0.8	100



KNIPEX MultiCrimp

PATENTED

Crimping Pliers with changer magazine

- > Just one tool for the most common crimping applications
- > Crimping dies changed quickly and easily without any additional tool
- > Sorted and protected storage of the interchangeable dies in a round magazine
- > Comfortable, powerful crimping pliers in professional quality
- > Same reliable crimping results as with fixed crimping dies
- > Consistently high crimping quality thanks to precision dies and forced locking mechanism (unlockable)
- > Chrome vanadium electric steel in special quality, oil-hardened
- > Round magazine: plastic, fibreglass-reinforced

97 33 01

- > Crimping pliers with round magazine and three interchangeable crimping dies for non-insulated open plug type connectors (4.8 + 6.3 mm width) from 0.5 - 6.0 mm²; for insulated terminals, plug connectors and butt connectors from 0.5 - 6.0 mm² and for insulated and non-insulated wire end sleeves from 0.25 - 6.0 mm²

97 33 02

- > Crimping pliers with round magazine and five interchangeable dies for non-insulated open plug type connectors (plug width 4.8 + 6.3 mm) from 0.5 - 6 mm²; for insulated terminals, plug connectors and butt connectors from 0.5 - 6 mm²; for insulated and non-insulated end sleeves (ferrules) from 0.25 - 6 mm²; for insulated and non-insulated wire end sleeves with 10 / 16 / 25 mm² and for non-insulated crimp terminals, tube and compression cable lugs in accordance with DIN 46234 and DIN 46235 and non-insulated crimp, butt and press connectors in accordance with DIN 46341 and DIN 46267



97 33 01



97 33 02

Compact, inexpensive and light-weight crimping pliers for fitting and repairs. The electrician needs only one tool now instead of five as before.



Changing position: service lever opens out for parallel jaw positioning



Changing the crimping dies: unlock the magazine position, take out the set of dies which the pliers have been pushed on



Fold in the service lever and press the pliers – ready for use again



Magazine for crimping dies can be carried on a belt



Clearly visible marking on the crimping dies with pictograms

Article No.	EAN	↔ mm			Applications	Capacity mm ²	AWG	Δ g
97 33 01	4003773-066927	250			non-insulated open plug type connectors (plug width 4.8 + 6.3 mm)	0.5 - 6	20 - 10	770
					insulated terminals, plug connectors + butt connectors	0.5 - 6	20 - 10	
					Wire ferrules	0.25 - 6	24 - 10	
97 33 02	066934	250			non-insulated open plug type connectors (plug width 4.8 + 6.3 mm)	0.5 - 6	20 - 10	870
					insulated terminals, plug connectors + butt connectors	0.5 - 6	20 - 10	
					Wire ferrules	0.5 - 6	24 - 10	
				non-insulated crimp terminals, tube and compression cable lugs in accordance with DIN 46234 and DIN 46235 and non-insulated crimp, butt and press connectors in accordance with DIN 46341 and DIN 46267	10 / 16 / 25	8 / 6 / 4		
97 39 05	070078				Crimping dies for non-insulated open plug type connectors (plug width 4.8 + 6.3 mm)			
97 39 09	077763				Crimping dies for insulated and non-insulated wire ferrules			
97 39 06	070085				Crimping dies for insulated terminals, plug connectors and butt connectors			
97 39 08	070092				Crimping dies for insulated and non-insulated wire ferrules			
97 39 13	070108				Crimping dies for non-insulated crimp terminals, tube and compression cable lugs in accordance with DIN 46234 and DIN 46235 and non-insulated crimp, butt and press connectors in accordance with DIN 46341 and DIN 46267			
97 39 90	070061				Changer magazine empty			

Crimp System Pliers

for exchangeable crimping dies

- > Just one tool for almost 1000 crimping applications
- > Almost parallel crimping motion
- > Consistently high crimping quality thanks to precision dies and forced locking mechanism (unlockable)
- > Crimping pressure has been set precisely (calibrated) in the factory, re-adjustable
- > Optimum transmission of force due to lever action for fatigue-reduced operation
- > Ergonomically designed handles
- > Different locators for precise positioning of the connectors
- > Crimping dies for applications not covered in the range offered here, may be available on request
- > Chrome vanadium electric steel in special quality, oil-hardened

97 43 05

- > With attached crimping dies for non-insulated open plug-type connectors (4.8 and 6.3 mm connector width)

97 43 06

- > With attached crimping dies for insulated terminals and plug connectors

97 43 200

- > Comes in a plastic case; foam insert with recesses for crimping dies and locators; with service tool (Allen key), screws and nuts; without crimping dies

97 43 200 A

- > Pliers without crimping dies, without case



97 43 200



97 43 200 A



97 43 05



97 43 06

With the possibility of crimping almost all currently available crimping connections with just one tool and state-of-the-art crimping pliers technology, the crimp system pliers solves almost all tasks in mobile and stationary crimping technology and is an excellent tool for professionals to use for standard crimping.



97 43 200 with crimping dies 97 49 06 for insulated terminals, plug connectors and butt connectors



97 43 200 with crimping dies 97 49 09 for wire ferrules



97 43 400 with crimping dies 97 49 24 and locator 97 49 93 for D-Sub plugs

Article No.	EAN	↔ mm		Pliers	Handles	Applications	Capacity mm ²	AWG	Δ g
97 43 200	4003773-030812	200		burnished	with multi-component grips	see crimping dies table			988
97 43 200 A	071587	200		burnished	with multi-component grips	see crimping dies table			574
97 43 05	031031	200		burnished	with multi-component grips	Crimp System Pliers for non-insulated open plug-type connectors (4.8 and 6.3 mm connector width)	0.5 - 6	20 - 10	618
97 43 06	031048	200		burnished	with multi-component grips	Crimp System Pliers for insulated terminals and plug connectors	0.5 - 6	20 - 10	610

KNIPEX eCrimp

PATENTED

Electromechanical Crimp System Pliers for exchangeable crimping dies

- > Strong electromechanical drive, no hydraulic components, no leakages
- > Possible use of over 40 KNIPEX crimping dies and locators as well as more than 1000 special crimping dies from the proven Crimp System Pliers (97 43 200)
- > Ergonomically optimised, user-friendly working height during workshop operation
- > LED working light for targeted illumination of the crimping area
- > Low noise level
- > Long servicing intervals (up to 25,000 crimping actions)! The KNIPEX eCrimp is designed to only require servicing after 25,000 crimping actions. This means the intervals between servicing the electromechanical crimping pliers is 2.5 : 1 in relation to conventionally actuated crimping pliers. The pliers are therefore available for crimping use for considerably longer. They do not need to be sent away frequently for servicing. High availability without downtimes while being serviced.
- > Powerful li-ion rechargeable battery (12 V; 1.5 Ah; 18 Wh); charge time approx. 30 min; no memory effect
- > Tether attachment point to prevent falling during field work
- > Max. pressing force of the jaws approx. 11 kN
- > Approx. 170 operating cycles for plug-in connectors with 10 mm² nominal size with a single battery charge

97 43 E

- > With euro plug

97 43 E AUS

- > With plug adapter for AS/NSZ 3112 (AUS+NZ)

97 43 E UK

- > With plug adapter for BS 5733 (GB)

97 43 E US

- > With plug NEMA 1-15P (USA / Canada / Mexico)



97 43 E

The KNIPEX eCrimp is the first electromechanically actuated model of crimping pliers in the world. The possible use of over 40 KNIPEX crimping dies and locators as well as more than 1,000 special crimping dies from the proven Crimp System Pliers (97 43 200). Its universal application range makes it an essential tool in the workshop and for rough field work.





















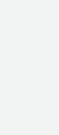



Article No.	EAN	Mains voltage/frequency	Connector socket	△△ g
97 43 E	4003773-076858	230 V / 50 Hz	CEE 7/16	1960
97 43 E UK	076865	230 V / 50 Hz	BS 5733	1960
97 43 E AUS	076872	230 V / 50 Hz	AS/NSZ 3112	1960
97 43 E US	077008	120 V / 60 Hz	NEMA 1-15P	1960

Crimping Dies

for KNIPEX Crimp System Pliers

Art. No.: 97 43 XX

> Up to 250 different die profiles available; special profiles on request

Article No.	EAN 4003773-		Applications	Capacity mm ²	AWG	Capacity SW mm	Sleeves Ø mm
97 49 04	030850		non-insulated open plug type connectors (plug width 2.8 + 4.8 mm)	0.1 - 2.5	27 - 14		
97 49 05	030867		non-insulated open plug type connectors (plug width 4.8 + 6.3 mm)	0.5 - 6	20 - 10		
97 49 06	030836		insulated terminals, plug connectors + butt connectors	0.5 - 6	20 - 10		
97 49 07	077749		heat shrinkable sleeve connectors	0.5 - 6	20 - 10		
97 49 08	030874		insulated and non-insulated wire ferrules	0.25 - 6	24 - 10		
97 49 09	030881		insulated and non-insulated wire ferrules	10 / 16 / 25	8 / 6 / 4		
97 49 10	076896		non-insulated tubular cable lugs and crimp terminals in accordance with DIN 46237 and non-insulated butt and crimp connectors in accordance with DIN 46341	0.25 - 0.75 / 1 - 1.5 / 2.5	20 - 18 / 18 - 16 / 14		
97 49 11	076902		non-insulated crimp terminals, tube and compression cable lugs in accordance with DIN 46234 and DIN 46235 and non-insulated crimp, butt and press connectors in accordance with DIN 46341 and DIN 46267	4 / 6 / 10	12 / 10 / 8		
97 49 14	077756		for non-insulated crimp terminals, tube and compression cable lugs in accordance with DIN 46234 and DIN 46235 and non-insulated crimp, butt and press connectors in accordance with DIN 46341 and DIN 46267	0.5 - 10	20 - 8		
97 49 15	043164		for plug connectors and angled spade connectors according to DIN 46346 Form A (1.5 - 2.5 mm ²) / for non-insulated, open lug connectors (straight version) according to DIN 46247 (2.5 - 6 mm ²)	1.25 - 2.5 / 3 - 6			
97 49 16	040675		insulated terminals + cable connectors	10 - 16	8 / 6		
97 49 18	063186		Twin wire ferrules for two flexible conductors	6 / 10 / 16			
97 49 19	030898		insulated and non-insulated wire ferrules	35 - 50	2 / 0		
97 49 20	045069		F-connectors for TV and satellite connections			7.0 / 8.4 / 8.1	7.7 / 9.5 / 9.5
97 49 23	052135		non-insulated terminals + cable connectors	16 / 25	6 / 4		
97 49 24	030911		D Sub; HD 20; HDE plug	0.03 - 0.56	32 - 20		
97 49 25	079798		for crimping connectors from the Micro-Fit™ series from Molex LLC		30 - 26 / 24 - 22 / 20		
97 49 26	079804		for crimping connectors in the Mini-Fit® series from Molex LLC		24 - 20 / 18 / 16		
97 49 27	079811		MQS connectors	0.25 / 0.35 / 0.5	24 / 22 / 20		
97 49 28	083757		connectors of the AMP Superseal 1.5 series from Tyco Electronics	0.35 - 0.5 / 0.75 / 1 / 1.5	32 - 20		
97 49 30	030904		non-insulated crimp connectors in accordance with DIN 46267	1.5 - 4 / 6 / 10	16 - 8 / 10 / 8		
97 49 35	034315		spark plug connectors and distributors	1	18		
97 49 40	030959		Coax connectors RG 58, 59, 62, 71, 223			5.4 / 6.48 / 1.72	6.4 / 7.6 / 2.1

Article No.	EAN 4003773-		Applications	Capacity mm ²	AWG	Capacity SW mm	Sleeves Ø mm
97 49 44	041443		PCB plug connector, type Phoenix-Contact module connector MCC-MT	0.14 / 1.5			
97 49 50	030966		Coax connectors/ car phone RG 58, 74, 188, 316			3.25 / 4.52 / 5.4 / 1.72 / 1.07 / 0.72	3.9 / 5.4 / 6.4 / 2.1 / 1.3 / 0.95
97 49 54	041450		TE Timer Contact System / Junior Power Timer / Receptacle Contacts (length 18.8 mm)	0.5 - 2.5			
97 49 59	073734		solar cable connectors Helios H4 (Amphenol)	2.5 / 4 / 6	14 - 10		
97 49 60	030928		turned contacts (HTS + Harting)	0.14 - 4	26 - 12		
97 49 61	045137		turned contacts	1.5 / 2.5 / 4 / 6	16 / 14 / 12 / 10		
97 49 62	063179		solar cable connectors (Huber + Suhner)	2.5 / 4	14 / 12		
97 49 63	066675		solar cable connectors (Huber + Suhner)	4 / 6	12 / 10		
97 49 64	044055		ABS connectors in motor vehicles	1 / 6	18 - 10		
97 49 65	066682		solar cable connectors MC3 (Multi-Contact)	2.5 - 6	14 / 10		
97 49 66	066699		solar cable connectors MC4 (Multi-Contact)	2.5 - 6	14 / 10		
97 49 66 4	072096		solar cable connectors MC4 (Multi-Contact) cutting – stripping – crimping	4	12		
97 49 66 6	072102		solar cable connectors MC4 (Multi-Contact) cutting – stripping – crimping	6	10		
97 49 67	066705		solar cable connectors (Hirschmann)	2.5 - 6	14 - 10		
97 49 68	066712		solar cable connectors (Tyco)	1.5 - 6	16 - 10		
97 49 69 1	072119		solar cable connectors gis® solar PST 40 (Wieland)	0.14 - 4	26 - 12		
97 49 69 2	072126		solar cable connectors gis® solar PST 40 (Wieland)	4 - 10	12 - 8		
97 49 70	030942		solar cable connectors MC4 (Multi-Contact)	4 - 10			
97 49 71	075066		solar cable connectors MC4 (Multi-Contact)	4 - 10	12 - 8		
97 49 72	076957		solar cable connectors MC3 (Multi-Contact)	4 / 6 / 10	12 / 10 / 8		
97 49 74	044062		unshielded Molex plugs				
97 49 76	047513		shielded Stewart plugs				
97 49 81	042778		fibre optic connectors, e.g. Harting			3.0 / 4.95 / 6.5	3.5 / 6.0 / 7.5
97 49 82	042785		fibre optic connectors, e.g. Telegärtner			3.25 / 3.65 / 4.52	3.6 / 4.0 / 5.4
97 49 83	044079		fibre optic connectors, e.g. FSMA-;ST-; SC- + STSC-/K-connectors			3.65 / 4.2 / 5.0	4.3 / 5.4 / 6.0
97 49 84	042792		fibre optic connectors, e.g. Huber/Suhner			3.8 / 4.3 / 4.95	4.5 / 5.2 / 6.0
97 49 87	043331		fibre optic connectors, e.g. FSMA-;ST- and MIC-connectors			8.7	9.5
97 49 94	030997	Locator for 97 49 04					
97 49 95	031000	Locator for 97 49 05					
97 49 93	047926	Locator for 97 49 24 (DSubplugs)					
97 49 28 1	083764	Wire Feed Stopper for 97 49 28					
97 49 59 1	073741	Locator for 97 49 59 (solar cable connectors Helios H4)					
97 49 90	031017	Locator for 97 49 60 (HTS+Harting)					
97 49 65 1	066729	Locator for 97 49 65 (solar cable connectors MC3)					
97 49 66 1	066736	Locator for 97 49 66 (solar cable connectors MC4)					
97 49 68 1	066743	Locator for 97 49 68 (solar cable connectors Solarlok)					
97 49 69 11	072133	Locator for 97 49 69 1 and 97 49 69 2					
97 49 71 1	075073	Locator for 97 49 71 (solar cable connectors MC4)					

Tool Case for Photovoltaics

- > With tools for photovoltaics
- > Without crimping dies – please order separately (see ref. 97 49...) for individual assortment
- > With service tools (hexagonal key) for the change of crimping dies
- > Shock-resistant plastic case
- > Foam insert with recesses for tools, crimping dies and locators
- > Dimensions, exterior (W x H x D):
345 x 80 x 280 mm



97 91 01

Article No.	EAN				Quantity	Δ g
97 91 01	4003773-070351			Tool Case for Photovoltaics	1	1964
	062998	///	12 12 11	Precision Insulation Stripper with adapted blades	1	
	039648	⚠ 1000 V ⚡ ⚙ ⚙	95 16 165	Cable Shears	1	
	030812	///	97 43 200	Crimp System Pliers for exchangeable crimping dies	1	

Set of Mounting Tools

for solar cable connectors MC4 (Multi-Contact)

- > Set of two mounting tools
- > To loosen and tighten cable glands of MC4 solar plugs
- > To open the locking of MC4 housings (even in case of mounted lock clip)
- > Tool: plastic, fibreglass-reinforced

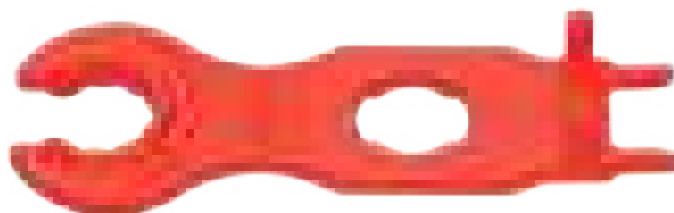

97 49 66 2

Article No.	EAN 4003773-	↔ mm	⚖ g
97 49 66 2	074106	115	18
97 49 66 1	066736	Locator for 97 49 66 (solar cable connectors MC4)	
97 49 66 4	072096	Crimping dies	
97 49 66 6	072102	Crimping dies	

Compression Tool

for coax connectors

- ▶ For crimping F, BNC and RCA connectors
- ▶ Robust design

- > Suitable for RG 59 / 6 / 11 cable
- > Rotatable head for different cable sizes
- > Rotatable insert for various types of connector
- > Adjusting screw for various connector lengths
- > Applicable among others for compression connectors Kathrein EMK 12; Cablecon F-56 CX3 5.1; Astro FKS 06



97 40 20 SB

Article No.	EAN 4003773-	↔ mm	Applications	⚖ g
97 40 20 SB	077626	175	for F, BNC and RCA connectors	430



Crimping Pliers for Scotchlok™ connectors

with side cutter

- > For crimping plastic-insulated telecommunication or signal cables using the U-contact principle in single Scotchlok™ connectors
- > No stripping necessary, U-shaped elements establish the connection
- > Cutting edges additionally induction-hardened, cutting edge hardness approx. 59 - 62 HRC
- > With opening spring
- > Vanadium electric steel; forged, oil-hardened



97 50 01

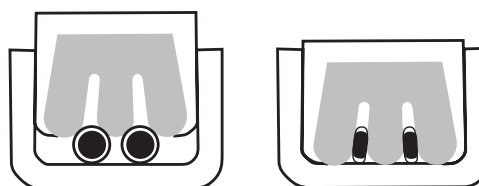

Article No.	EAN 4003773-	↔ mm	Head	Handles	Applications	Capacity Ø mm	⚖ g
97 50 01	028239	155	 	polished plastic coated	Scotchlok™ single connector	0.4 - 1.1	135

Crimping Pliers for Western plugs

- > Professional tool for cutting and stripping unshielded ribbon telephone cables
- > For crimping 6- and 8-pole Western plugs type RJ 11/12 (9.65 mm width) and type RJ 45 (11.68 mm width)
- > Precise crimping process thanks to parallel crimping
- > Repetitive, high crimping quality due to integral lock (self-releasing mechanism)
- > With length cutter and stripping knife for ribbon cables 6 and 12 mm length
- > With additional stripping device for round cables
- > Optimum transmission of force due to lever action for fatigue-reduced operation
- > For Western plug type RJ 10 (7.65 mm wide), RJ 11/12 (9.65 mm wide) and RJ 45 (11.68 mm wide)
- > Head burnished, two-colour dual component handles
- > Chrome vanadium electric steel in special quality, oil-hardened







97 51 10



97 51 12



Article No.	EAN	↔ mm			Handles	Capacity	△ g	
97 51 10	043171	190			with multi-component grips	RJ 11/12 (6-poles) 9.65 mm RJ 45 (8-poles) 11.68 mm	340	
97 51 12	043188	200			with multi-component grips	RJ 10 (4-poles) 7.65 mm RJ 11/12 (6-poles) 9.65 mm RJ 45 (8-poles) 11.68 mm	533	
97 59 06	029700	4 spare blades for 97 51 10						
97 59 12	069997	3 spare blades for 97 51 12						

Crimping Pliers for RJ45 Western plugs

Professional network crimping tool: cutting, stripping, crimping – crimps unshielded and shielded 8-pole modular plugs

- ▶ All-in-one tool for cable cutting, stripping of round cable and crimping of common RJ45 plugs
- ▶ Reliably crimps shielded and unshielded RJ45 Western plugs (8P8C)
- ▶ With adjustable retaining bracket, for all common RJ45 plugs with closed and non-closed housings
- > Exact crimping process due to parallel crimp and self-releasing mechanism
- > Dual crimping points for equal and balanced crimping pressure
- > Quick cutting and stripping of CAT-cables with the high-quality blade
- > With ergonomic multi-component handles
- > For current and future Western connection technology in the network / Ethernet area and Western modular plugs with 8P8C pin assignment



For shielded and unshielded Western plugs!



Article no.	EAN 4003773-	↔ mm		Handles	Capacity	⚖ g	
97 51 13	087908	190		with multi-component grips	Western plugs, 8-poles	345	
97 59 12	069997	1 spare blade for 97 51 13					

Crimping Pliers

short design

- > Consistently high crimping quality thanks to precision dies and forced locking mechanism (unlockable)
- > Crimping pressure has been set precisely (calibrated) in the factory, re-adjustable
- > Optimum transmission of force thanks to toggle lever for fatigue-reduced operation
- > Good handling due to 20° angled head, low weight and short design
- > Optimum transmission of force due to lever action for fatigue-reduced operation
- > Chrome vanadium electric steel in special quality, oil-hardened

97 52 14

- > Available as accessory: locator for non-insulated open plug-type connectors



97 52 14



97 52 20

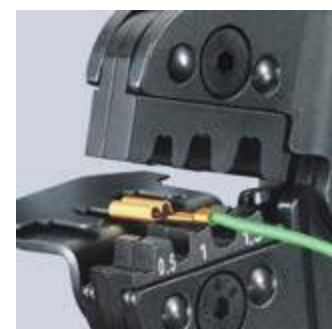

Article No.	EAN 4003773-	↔ mm		Handles	Applications	Capacity mm ²	AWG	⚖ g
97 52 14	026808	195		with multi-component grips	non-insulated open plug type connectors (plug width 2.8 + 4.8 mm)	0.1 - 1.5	27 - 16	387
97 52 20	026853	195		with multi-component grips	Coax-, BNC- and TNC-connectors RG 58/59/62/71/223			380
97 59 14	026976	Locator for 97 52 14						

Crimping Pliers

also for two-hand operation

- > For solder-free electrical connections
- > The ingenious lever transmission reduces the handforce up to 30 % compared with regular crimping pliers
- > Consistently high crimping quality thanks to precision dies and forced locking mechanism (unlockable)
- > Crimping pressure has been set precisely (calibrated) in the factory, re-adjustable
- > Two-hand operation for easy crimping of large conductor diameters
- > Easy handling as a result of well balanced centre of gravity, angled head and ergonomically shaped handles
- > Chrome vanadium electric steel in special quality, oil-hardened



First step: move the handle with two fingers only until both jaws touch the connector to be crimped



Second step: now use the whole hand for further crimping procedure



Third step: when greater hand force is required, such as e.g. when crimping insulated connectors 6.0 mm², two-hand operation is possible by the longer handles



97 52 04



97 52 05



97 52 06



97 52 08



97 52 09



97 52 10



97 52 13



97 52 19

Article No.	EAN 4003773-	↔ mm			Applications	Capacity mm ²	AWG	Δ g
97 52 04	025450	250			non-insulated open plug type connectors (plug width 2.8 + 4.8 mm)	0,1 - 2,5	27 - 14	562
97 52 05	025467	250			non-insulated open plug type connectors (plug width 2.8 + 4.8 mm)	0,5 - 6	20 - 10	572
97 52 06	025474	250			insulated terminals, plug connectors and butt connectors	0,5 - 6	20 - 10	565
97 52 08	025481	250			insulated and non-insulated end sleeves (ferrules)	0,25 - 6	24 - 10	565
97 52 09	025498	250			insulated and non-insulated end sleeves (ferrules)	10 / 16 / 25	8 / 6 / 4	571
97 52 10	023678	250			Coax-, BNC- and TNC-connectors			577
97 52 13	048084	250			non-insulated crimp terminals, tube and compression cable lugs in accordance with DIN 46234 and DIN 46235 and non-insulated crimp, butt and press connectors in accordance with DIN 46341 and DIN 46267	0,5 - 10	20 - 8	558
97 52 19	052142	250			insulated and non-insulated end sleeves (ferrules)	35 - 50	2 / 0	567
97 52 23	052159	250			non-insulated terminals + cable connectors	16 / 25	6 / 4	565
97 52 18	026839	250			Twin end sleeves (ferrules) 2 x 6 / 2 x 10 / 2 x 16 mm ²		2 x 10 / 2 x 8 / 2 x 6	571
97 49 94	030997	Locator for 97 49 04 / 97 52 04 / 97 52 34						
97 49 95	031000	Locator for 97 49 05 / 97 52 05 / 97 52 35						

KNIPEX PreciForce

Crimping Pliers

- > Consistently high crimping quality thanks to precision dies and forced locking mechanism (unlockable)
- > Crimping pressure has been set precisely (calibrated) in the factory, re-adjustable
- > Optimum transmission of force thanks to toggle lever for fatigue-reduced operation
- > Good handling thanks to favourable handle position, low weight, compact design and ergonomically shaped handles
- > Chrome vanadium electric steel in special quality, oil-hardened

For daily crimping applications, the specialist likes crimping pliers that work precisely and reliably. In addition, they should be light, comfortable to use, robust and reasonably priced: KNIPEX PreciForce.



97 52 36



97 52 37



97 52 30



97 52 33



97 52 34



97 52 35



97 52 36



97 52 37



97 52 38



97 52 50

Article No.	EAN 4003773-	↔ mm		Applications	Capacity mm ²	AWG	Δ g	
97 52 30	051855	220		compression joints according to DIN 46267	1,5 - 4 / 6 / 10	16 - 8	477	
97 52 33	051862	220		non-insulated crimp terminals, tube and compression cable lugs in accordance with DIN 46234 and DIN 46235 and non-insulated crimp, butt and press connectors in accordance with DIN 46341 and DIN 46267	0,5 - 10	20 - 8	478	
97 52 34	051879	220		non-insulated open plug type connectors (plug width 2.8 + 4.8 mm)	0,1 - 2,5	27 - 14	483	
97 52 35	051886	220		non-insulated open plug type connectors (plug width 4.8 + 6.3 mm)	0,5 - 6	20 - 10	494	
97 52 36	051893	220		insulated terminals + cable connectors	0,5 - 6	20 - 10	487	
97 52 37	063193	220		heat shrinkable sleeve connectors	0,5 - 6	20 - 10	478	
97 52 38	051909	220		insulated and non-insulated end sleeves (ferrules)	0,25 - 6	24 - 10	493	
97 52 50	051916	220		COAX-, BNC- and TNC-connectors for RG 58; 174; 188; 316			498	
97 49 94	030997	Locator for 97 49 04 / 97 52 04 / 97 52 34						
97 49 95	031000	Locator for 97 49 05 / 97 52 05 / 97 52 35						

Four-Mandrel Crimping Pliers for turned contacts

- > For crimping turned contacts
- > Four-mandrel crimping for top-quality crimping connections
- > Mandrel gauge to check the basic setting
- > Repetitive, high crimping quality due to integral lock (self-releasing mechanism)
- > Optimum transmission of force due to highly effective lever action for fatigue-reduced operation
- > High operation comfort thanks to handy shape
- > Chrome vanadium electric steel in special quality, oil-hardened

97 52 63

- > Fine adjustment of pressure depending on the conductor's diameter by means of adjusting wheel. Pliers in a plastic case with foam insert and standard locator for precise positioning of the contacts

97 52 63 DG

- > Crimping capacity can be adjusted in increments of 0.01 mm; With digital display of the preset crimping capacities and possibility of re-calibration via RESET function with electronic wear monitoring; Adjustment in mm, inches or comparable selection positions according to MIL; Pliers in a plastic case with foam insert and standard locator for precise positioning of the contacts

97 52 64

- > Pressure adjustment depending on the conductor's diameter by means of adjusting wheel in 4 different positions; Locator for positioning the contacts

97 52 65

- > Fine adjustment of pressure depending on the conductor's diameter by means of adjusting wheel; Locator for positioning the contacts; With table for calculating the settings; Pliers in a plastic case with foam insert

97 52 65 A

- > Fine adjustment of pressure depending on the conductor's diameter by means of adjusting wheel; With table for calculating the settings; Pliers in a plastic case with foam insert

97 52 65 DG

- > Crimping capacity can be adjusted in increments of 0.01 mm; With digital display of the preset crimping capacities and possibility of re-calibration via RESET function with electronic wear monitoring; Adjustment in mm, inches or comparable selection positions according to MIL; With table for calculating the settings; Pliers in a plastic case with foam insert and standard locator for precise positioning of the contacts

97 52 65 DGA

- > Crimping capacity can be adjusted in increments of 0.01 mm; With digital display of the preset crimping capacities and possibility of re-calibration via RESET function with electronic wear monitoring; Adjustment in mm, inches or comparable selection positions according to MIL; With table for calculating the settings; Pliers in a plastic case with foam insert; Without locator

97 59 65 2

- > Locator for holding turned contacts for crimping; Precisely adjustable to the length (20 - 45 mm) and diameter (1 - 8 mm) of the crimping connector; Locator that is universally adjustable (in length and diameter) for the repeatable exact alignment of turned contacts in crimping pliers; can be set to all commercially available turned contacts in the four-mandrel crimping pliers' capacity range



97 52 63

(PATENTED)



97 52 63 DG



97 52 64



97 52 65

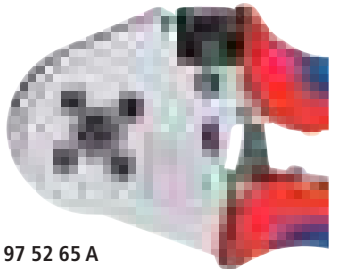

97 52 65 A



97 52 65 DG



97 52 65 DGA



97 59 65 2

Universal Locator

Turned contacts are used for particularly demanding plug-type connections, e.g. in medical industry and aeronautics. Extremely reliable crimping connections can be achieved only with pliers that work with absolute precision and maintain the required crimping depth in the 1/100 mm range.



Standard locator



Multi-functional digital display, adjustment in mm, inch or comparable selection positions according to MIL



Article No.	EAN 4003773-	↔ mm			Pliers	Handles	Applications	Capacity mm ²	AWG	⚖ g
97 52 63	050148	180			chrome plated	with multi-component grips	turned contacts	0.08 - 2.5	28 - 14	388
97 52 63 DG	063209	195			chrome plated	with multi-component grips	turned contacts	0.08 - 2.5	28 - 14	388
97 52 64	044093	180			chrome plated	with multi-component grips	turned contacts	0.08 - 2.5	28 - 14	424
97 52 65	045236	230			chrome plated	with multi-component grips	turned contacts (Harting; Ilme; Phoenix; Amphenol; Walther; HTS; Contact; Weidmüller)	0.14 - 6	26 - 10	676
97 52 65 A	071594	250			chrome plated	with multi-component grips	turned contacts (Harting; Ilme; Phoenix; Amphenol; Walther; HTS; Contact; Weidmüller)	0.14 - 6	26 - 10	604
97 52 65 DG	063216	250			chrome plated	with multi-component grips	turned contacts (Harting; Ilme; Phoenix; Amphenol; Walther; HTS; Contact; Weidmüller)	0.14 - 6	26 - 10	633
97 52 65 DG A	071990	250			chrome plated	with multi-component grips	turned contacts (Harting; Ilme; Phoenix; Amphenol; Walther; HTS; Contact; Weidmüller)	0.14 - 6	26 - 10	633
97 59 14	026976	Locator for 97 52 14								
97 59 65 2	071600	Universal Locator for 97 52 65 / 97 52 65 A / 97 52 65 DG / 97 52 65 DG A								

Self-Adjusting Crimping Pliers for wire ferrules

PATENTED

with lateral access

► Narrow handle width and improved ergonomics

- > For crimping wire ferrules according to DIN 46228 parts 1 + 4
- > Self-adjustment to the size of wire ferrules required
- > Repetitive, high crimping quality due to integral lock (self-releasing mechanism)
- > Tools have been set precisely (calibrated) in the factory
- > Optimum transmission of force thanks to toggle lever for fatigue-reduced operation
- > Handy shape and low weight provide high operation comfort
- > Chrome vanadium electric steel in special quality, oil-hardened

The small crimping pliers for wire end sleeves with two major advantages for the user:

- > Automatic adjustment to the end sleeves used: This makes work easier for the professional and offers reliable and fast crimping
- > Expanded range of applications

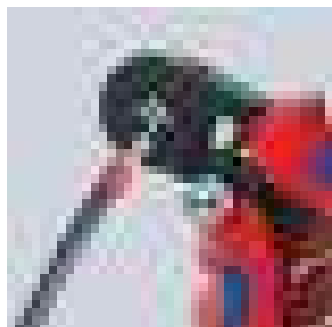

Crimping capacity can be switched over simply from 10 mm² to 16 mm².

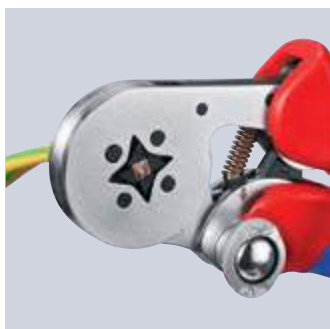

97 53 04



97 55 04



97 55 14

Article No.	EAN 4003773-	↔ mm			Pliers	Handles	Applications	Capacity mm ²	AWG	△ g
97 53 04	028017	180			burnished	with multi-component grips	Wire ferrules	0.08 - 10 / 16	28 - 6	459
97 55 04	084853	180			chrome plated	with multi-component grips	Wire ferrules	0.08 - 10 / 16	28 - 6	459
97 55 14	084860	180			chrome plated	with multi-component grips	Wire ferrules	0.08 - 10	28 - 8	445
97 59 30	053965	Extension spring for 97 53 4/5/8/9/14 thin								
97 59 31	053972	Extension spring for 97 53 4/5/8/9/14 thick								

Now capable of crimping twin wire ferrules up to 2 x 10 mm²

Automatic Crimping Pliers for Wire Ferrules

PATENTED

Now with greater crimping capacity: easy crimping of wire ferrules up to 16 mm² or twin wire ferrules up to 2 x 10 mm²

- ▶ Hexagonal crimp layout for near round form, particularly suitable for confined connections
- ▶ Automatic self-adjustment to wire ferrules with ratcheting mechanism ensuring a complete crimping cycle for consistent, reliable and fast crimping
- > Reliable hexagonal crimping of wire ferrules from 0.08 to 16 mm² (AWG 6) by simply turning and setting the adjusting wheel and all twin wire ferrules up to 2 x 10 mm² (AWG 2 x 8)
- > Automatic adaptation via self-adjustment to the wire ferrule size for precise and quick crimping
- > Crimping pressure calibrated in the factory for precise crimping
- > Optimum transmission of force due to toggle lever for fatigue-reduced operation
- > Ergonomic and comfortable handle, smooth operation and lightweight
- > Crimping of wire ferrules according to DIN 46228 parts 1+4



The crimping pliers can be adjusted to large wire ferrules of 16 mm² or 2 x 10 mm² with the adjusting wheel.



Enormous capacity: crimps single wire ferrules up to 16 mm² or twin wire ferrules up to 2 x 10 mm²



Suitable for fine conductors: crimps fine conductors from 0.08 mm²

Also suitable for twin wire ferrules: capacity up to 2 x 10 mm²

Article no.	EAN	↔ mm	Handles	Application	Capacity mm ²	AWG	⚖ g
97 53 14	041474	180	with multi-component grips	Hexagonal crimp	Wire ferrules 0.08 – 16 Twin wire ferrules 2 x 10	Wire ferrules 6 Twin wire ferrules 2 x 8	416
97 53 14 SB	048497	180	with multi-component grips	Hexagonal crimp	Wire ferrules 0.08 – 16 Twin wire ferrules 2 x 10	Wire ferrules 6 Twin wire ferrules 2 x 8	416

KNIPEX Twistor® 16

Self-Adjusting Crimping Pliers for wire ferrules with rotatable die head

- > Self-adjusting crimping pliers for wire ferrules with rotatable crimp head
- > Crimp head can be freely rotated 360°, with 8 locking positions
- > Square crimp profile, high capacity range from 0.14 to 16 mm²
- > Wire ferrules can be crimped from almost any working position
- > Crimping pliers adjust automatically to different cross-sections
- > Crimp opening accessible from both sides, extra-long wire ferrules can be fed in
- > Crimping of Twin wire ferrules up to 2 x 6 mm² possible
- > Repetitive, high crimping quality due to integral lock (self-releasing mechanism)
- > Light and handy tool, manual force reinforced by toggle lever mechanism
- > Chrome vanadium electric steel in special quality, oil-hardened



97 53 18

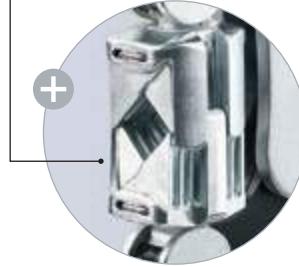

Crimp head can be freely rotated 360°



Crimp head can be rotated 360° for optimal accessibility, even in confined spaces



97 90 13

All-round care-free solution: KNIPEX Twistor 16 with accessories in the practical TANOS MINI-systainer®



Twin wire ferrules up to 2 x 6 mm² can be crimped without adjustment



Uniquely flexible: connectors can be inserted in the rotatable crimp head from almost any position



Article No.	EAN	↔ mm			Pliers	Handles	Applications	Capacity mm ²	AWG	Δ g
97 53 18	4003773-082729	240			chrome plated	with multi-component grips	Wire ferrules	0.14 - 16	26 - 6	478

Self-Adjusting Crimping Pliers for wire ferrules

with front loading

- > For crimping wire ferrules according to DIN 46228 parts 1 + 4
- > Self-adjusting adaptation to the desired wire ferrule size: no wrong crimps caused by using the wrong die
- > Frontal insertion of the wire ferrules into the pliers
- > Repetitive, high crimping quality due to integral lock (self-releasing mechanism)
- > Crimping pressure has been set precisely (calibrated) in the factory, re-adjustable
- > Optimum transmission of force thanks to toggle lever for fatigue-reduced operation
- > Handy shape and low weight provide high operation comfort
- > Chrome vanadium electric steel in special quality, oil-hardened

97 53 08

- > Compression from 0.08 - 10.0 mm² in one profile; wire end sleeves up to 2.5 mm² can also be loaded parallelly from the side; suitable in particular for all twin wire end sleeves up to 2 x 4 mm² or 2 x AWG 10

97 53 09

- > Compression from 0.08 - 10.0 and 16.0 mm² in one profile; with selector lever for setting the crimping area either to 0.08 - 10 mm² or 16 mm²; suitable in particular for all twin wire end sleeves up to 2 x 6 mm² or 2 x AWG 8



97 53 08



97 53 09



97 53 08: lateral loading of wire ferrules up to 2.5 mm² parallelly from the side e.g. in confined areas



Front loading of wire ferrules e.g. in switchboards



Square-Crimp

The crimping pliers for end sleeves (ferrules) with three great advantages for the user:

- > Automatic self-adjustment to the wire end sleeve used: this allows the specialist to work with less strain and enables secure, reliable and quick crimping.
- > Range of applications also for large cross-sections: square crimping 0.08 to 10 + 16 mm²
- > Front loading: very helpful under difficult working conditions in confined areas.

Article No.	EAN	↔ mm			Pliers	Handles	Applications	Capacity mm ²	AWG	Δ g
97 53 08	040187	190			burnished	with multi-component grips	Wire ferrules	0.8 - 10	28 - 8	477
97 53 09	044550	190			burnished	with multi-component grips	Wire ferrules	0.08 - 10 / 16	28 - 6	486
97 59 30	053965	Extension spring for 97 53 4 / 5 / 8 / 9 / 14 thin								
97 59 31	053972	Extension spring for 97 53 4 / 5 / 8 / 9 / 14 thick								

Crimping Pliers for micro plugs

parallel crimping

- > Parallel crimping performance to satisfy the particularly high standards of small connectors
- > Consistently high crimping quality thanks to precision dies and forced locking mechanism (unlockable)
- > Crimping pressure has been set precisely (calibrated) in the factory, re-adjustable
- > Optimum transmission of force thanks to toggle lever for fatigue-reduced operation
- > Crimping pliers for other mini plugs such as HD 22, Modu IV, Micro Timer, MQS ... on request
- > Chrome vanadium electric steel in special quality, oil-hardened



97 54 24

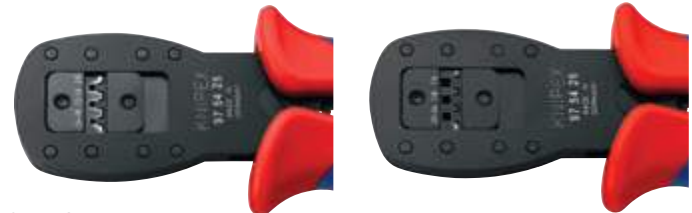

97 54 25



97 54 26



97 54 27

Article No.	EAN 4003773-	↔ mm			Pliers	Handles	Applications	Capacity mm ²	AWG	⚖ g
97 54 24	060215	190			burnished	with multi-component grips	D Sub; HD 20; HDE plug	0.03 - 0.56	32 - 20	305
97 54 25	079859	190			burnished	with multi-component grips	for crimping connectors from the Micro-Fit™ series from Molex LLC		30 - 26 / 24 - 22 / 20	305
97 54 26	079866	190			burnished	with multi-component grips	for crimping connectors in the Mini-Fit® series from Molex LLC		16 / 18 / 20 - 24	305
97 54 27	079873	190			burnished	with multi-component grips	MQS connectors	0.25 / 0.35 / 0.5		305

Crimping Pliers for wire ferrules

with trapezoid crimp

- > For crimping wire ferrules according to DIN 46228 parts 1 + 4 in the range from 0.25 up to 2.5 mm²
- > Crimping in marked trapezoidal dies for reliable connections between the sleeve and the conductor
- > Vanadium electric steel; forged, oil-hardened



97 61 145 A



97 68 145 A

Article No.	EAN 4003773-	↔ mm			Head	Handles	Capacity mm ²	AWG	⚖ g
97 61 145 A	035558	145			polished	plastic coated	0.25 - 2.5	24 - 14	140
97 62 145 A	060154	145			polished	with multi-component grips	0.25 - 2.5	24 - 14	170
97 68 145 A	071754	145			polished	insulated with multi-component grips, VDE-tested	0.25 - 2.5	24 - 14	175

Crimping Pliers for wire ferrules

with mandrel crimp

- ▶ Light and slim design
 - ▶ Also as VDE version
 - ▶ Easy crimping due to optimised transmission ratio
- > For crimping wire ferrules according to DIN 46228 parts 1 + 4 from 0.25 to 16 mm²
- > Crimping in marked half-round dies for reliable connections between the sleeve and the conductor
- > 9 particularly deep dies with conical side faces
- > Special tool steel, forged, oil-hardened

97 78 180 T *

- > Pliers with tether attachment point for mounting a fall protection



97 71 180



97 72 180



97 78 180



97 78 180 T

Article No.	EAN 4003773-	↔ mm		Head	Handles	Applications	Capacity mm ²	AWG	Δ g
97 71 180	040668	180		polished	plastic coated	Wire ferrules	0.25 - 16	24 - 6	205
97 72 180	060185	180		polished	with multi-component grips	Wire ferrules	0.25 - 16	24 - 6	242
97 78 180	072003	180		polished	insulated with multi-component grips, VDE-tested	Wire ferrules	0.25 - 16	24 - 6	254
97 78 180 T	081531	180		polished	insulated with multi-component grips, with integrated insulated tether attachment point, VDE tested	Wire ferrules	0.25 - 16	24 - 6	260

Crimping Pliers for wire ferrules

with front loading

- > For crimping wire ferrules according to DIN 46228 parts 1 + 4 in the range 0.5 to 6 mm²
- > Ideal for work in confined areas, e.g. in narrow and deep switch boxes
- > Special tool steel, forged, oil-hardened



97 81 180

Article No.	EAN 4003773-	↔ mm		Head	Handles	Applications	Capacity mm ²	AWG	Δ g
97 81 180	019794	180		polished	plastic coated	Wire ferrules	0.5 - 6	20 - 10	209

*Other tools with tethering can be found from page 272

Crimp Assortments

for non-insulated wire ferrules

- > In a TANOS MINI-systainer® (solid plastic box)
- > T-Loc fastener for one-handed operation: open or close the systainer® with one turn and connect to a second systainer®
- > Opening when connected: fast and simple access to content without disconnecting
- > Two stackable plastic inserts with 6 trays each for connectors
- > With an assortment of wire ferrules with/without collar

97 90 05

- > With Crimping Pliers for end sleeves 97 71 180; Wire end sleeves without collar

97 90 17

- > With crimping pliers for wire ferrules 97 53 09 and self-adjusting insulation stripper 12 42 195

97 90 23

- > With Crimping Pliers KNIPEX PreciForce for wire end sleeves 97 52 38

97 90 06

- > With Crimping Pliers for end sleeves 97 71 180; Wire end sleeves with collar

97 90 09

- > With Self-Adjusting Crimping Pliers for wire end sleeves 97 53 04

97 90 10

- > With Self-Adjusting Insulation Stripper 12 40 200; With Self-Adjusting Crimping Pliers for wire end sleeves 97 53 04

97 90 13

- > With KNIPEX Twistor 16 97 53 18 crimping pliers for wire ferrules

97 90 14

- > With crimping pliers for wire ferrules KNIPEX Twistor 16 97 53 18 and automatic insulation stripper KNIPEX PreciStrip16 12 52 195

97 90 15

- > With crimping pliers for wire ferrules 97 53 09 and automatic insulation stripper KNIPEX PreciStrip16 12 52 195

97 90 16

- > With crimping pliers for wire ferrules 97 53 09 and self-adjusting insulation stripper 12 40 200



97 90 05



97 90 10



97 90 13



97 90 23



Several boxes can be connected with each other

Article No.	EAN 4003773-		Pliers	200 x mm ²	150 x mm ²	100 x mm ²	75 x mm ²	50 x mm ²	40 x mm ²	Δ g
97 90 05	025535		97 71 180	0,5 / 0,75 / 1 / 1,5 / 2,5	4 / 6			10 / 16		930
97 90 06	025542		97 71 180	0,5 / 0,75 / 1 / 1,5	2,5		6	10	16	1000
97 90 09	028574		97 53 04	0,5 / 0,75 / 1 / 1,5 / 2,5		4 / 6		10		1420
97 90 10	046202		12 40 200 97 53 04	0,5 / 0,75 / 1 / 1,5 / 2,5		4 / 6		10		1353
97 90 13	083474		97 53 18	0,5 / 0,75 / 1 / 1,5	2,5		6	10	16	1270
97 90 14	084884		97 53 18 12 52 195	0,5 / 0,75 / 1 / 1,5	2,5		6	10	16	1450
97 90 15	084877		97 53 09 12 52 195			1,5 / 2,5		6	4	1450
97 90 16	086024		12 40 200 97 53 09	0,5 / 0,75 / 1 / 1,5 / 2,5		4 / 6		10		1450
97 90 17	086031		97 53 09	0,5 / 0,75 / 1 / 1,5 / 2,5		4 / 6		10		1450
97 90 23	062158		97 52 38	0,5 / 0,75 / 1 / 1,5 / 2,5		4 / 6				1226
97 90 00 LE	054009	TANOS MINI-systainer® empty								900

Crimp Assortments

for cable connectors

- > In a TANOS MINI-systainer® (solid plastic box)
- > T-Loc fastener for one-handed operation: open or close the systainer® with one turn and connect to a second systainer®
- > Opening when connected: fast and simple access to content without disconnecting
- > Two stackable plastic inserts with 6 trays each for connectors
- > With an assortment of standard cable connectors

97 90 21

- > With Crimping Pliers KNIPEX PreciForce® 97 52 36 (for insulated terminals and plug connectors)

97 90 22

- > With Self-Adapting Universal Insulation Stripper KNIPEX Multi-strip 10, 12 42 195; with Crimping Pliers KNIPEX PreciForce 97 52 36 (for insulated terminals and plug connectors)

97 90 25

- > With crimping pliers 97 22 240

97 90 26

- > With crimping pliers 97 32 240



97 90 21



97 90 22



97 90 25



97 90 26

Article No.	EAN	Image	Pliers	Cable Connectors			g
					Quantity	Cable mm ²	
97 90 21	062134		97 52 36	Blade Terminal Sockets, 6.3 x 0.8 mm	25	0,5 - 1	1416
					25	1,5 - 2,5	
					25	0,5 - 1	
				Round Sockets, Ø 4 mm	25	0,5 - 1	
				Cable Connectors, eye type, Ø 4 mm	25	4 - 6	
					25	4 - 6	
				Cable Connectors, eye type, Ø 5 mm	25	1,5 - 2,5	
					25	1,5 - 2,5	
				Cable Connectors, eye type, Ø 6 mm	25	1,5 - 2,5	
				Butt Connectors, insulated, red	25	0,5 - 1	
				Butt Connectors, insulated, blue	25	4 - 6	
				Round Pin Plugs, Ø 4 mm	25	1,5 - 2,5	
97 90 22	062141		97 52 36 12 42 195	Blade Terminal Sockets, 6.3 x 0.8 mm	25	0,5 - 1	1527
					25	1,5 - 2,5	
					25	0,5 - 1	
				Cable Connectors, eye type, Ø 4 mm	25	0,5 - 1	
				Cable Connectors, eye type, Ø 5 mm	25	0,5 - 1	
				Cable Connectors, eye type, Ø 6 mm	25	1,5 - 2,5	
				Cable Connectors, eye type, Ø 8 mm	25	1,5 - 2,5	
				Cable Connectors, eye type, Ø 4 mm	25	1,5 - 2,5	
				Cable Connectors, eye type, Ø 5 mm	25	4 - 6	
				Cable Connectors, eye type, Ø 6 mm	25	4 - 6	
				Butt Connectors, insulated, red	25	0,5 - 1	
				Butt Connectors, insulated, blue	25	1,5 - 2,5	
Butt Connectors, insulated, yellow	25	4 - 6					
97 90 25	076971		97 22 240	Blade Terminal Sockets, 6.3 x 0.8 mm	25	0,5 - 1,5	1150
					25	1 - 2,5	
				Cable Connectors, eye type, Ø 4 mm	25	0,5 - 1	
				Cable Connectors, eye type, Ø 5 mm	25	1,5 - 2,5	
				Cable Connectors, eye type, Ø 4 mm	25	4 - 6	
				Cable Connectors, eye type, Ø 5 mm	25	0,5 - 1	
				Cable Connectors, eye type, Ø 6 mm	25	1,5 - 2,5	
					25	0,5 - 1	
				Cable Connectors, eye type, Ø 8 mm	25	1,5 - 2,5	
				Butt Connectors, insulated, red	25	0,5 - 1	
				Butt Connectors, insulated, blue	25	1,5 - 2,5	
				Butt Connectors, insulated, yellow	25	4 - 6	
97 90 26	079521		97 32 240	Non-insulated Blade Terminal Sockets 6.3 x 0.8 mm	25	1,5 - 2,5	1420
					25	4 - 6	
				Blade Terminal Sockets 6.3 x 0.8 mm	25	0,5 - 1	
					25	0,5 - 1	
				Blade Terminal Plugs 6.3 x 0.8 mm	25	1,5 - 2,5	
					25	4 - 6	
				Cable Connectors, eye type Ø 4 mm	25	4 - 6	
					25	0,5 - 1	
				Butt Connectors, insulated, red	25	1,5 - 2,5	
				Butt Connectors, insulated, blue	25	0,5 - 1	
				Butt Connectors, insulated, yellow	25	0,5 - 1	
				97 90 00 LE	054009	TANOS MINI-systainer® empty	

Blade Terminal Sockets

insulated

Article No.	EAN 4003773-		Width x Thickness mm ²	Cable mm ²	AWG	Colour	
97 99 001	075882	Blade Terminal Sockets insulated	2.8 x 0.5	0.5 - 1	20 - 18	Red	100
97 99 010	075899	Blade Terminal Sockets insulated	4.8 x 0.8	0.5 - 1	20 - 18		100
97 99 020	075912	Blade Terminal Sockets insulated	6.3 x 0.8	0.5 - 1	20 - 18		100
97 99 011	075905	Blade Terminal Sockets insulated	4.8 x 0.8	1.5 - 2.5	16 - 14	Blue	100
97 99 021	075929	Blade Terminal Sockets insulated	6.3 x 0.8	1.5 - 2.5	16 - 14		100
97 99 030	075943	Blade Terminal Sockets insulated	7.7 x 0.8	1.5 - 2.5	16 - 14		100
97 99 022	075936	Blade Terminal Sockets insulated	6.3 x 0.8	4 - 6	12 - 10	Yellow	100



97 99 022

Plug Connectors

non-insulated

Article No.	EAN 4003773-		Width x Thickness mm ²	Cable mm ²	AWG		
97 99 050	075950	Plug connector non-insulated	2.8 x 0.8	0.5 - 1	20 - 18		100
97 99 060	075967	Plug connector non-insulated	4.8 x 0.8	1.5 - 2.5	16 - 14		100
97 99 070	075974	Plug connector non-insulated	6.3 x 0.8	0.5 - 1.5	20 - 16		100
97 99 071	075981	Plug connector non-insulated	6.3 x 0.8	1 - 2.5	18 - 14		100



97 99 050

Flat Pin Accessory Distributors

insulated

Article No.	EAN 4003773-		Width x Thickness mm ²	Cable mm ²	AWG	Colour	
97 99 090	075998	Flat Pin Accessory Distributors insulated	6.3 x 0.8	0.5 - 1	20 - 18	Red	100
97 99 091	076001	Flat Pin Accessory Distributors insulated	6.3 x 0.8	1.5 - 2.5	16 - 14	Blue	100
97 99 092	076018	Flat Pin Accessory Distributors insulated	6.3 x 0.8	4 - 6	12 - 10	Yellow	100



97 99 091

Blade Terminal Plugs

insulated

Article No.	EAN 4003773-		Width x Thickness mm ²	Cable mm ²	AWG	Colour	
97 99 110	076025	Blade Terminal Plug insulated	6.3 x 0.8	0.5 - 1	20 - 18	Red	100
97 99 111	076032	Blade Terminal Plug insulated	6.3 x 0.8	1.5 - 2.5	16 - 14	Blue	100
97 99 112	076049	Blade Terminal Plug insulated	6.3 x 0.8	4 - 6	12 - 10	Yellow	100



97 99 111

Round Sockets

insulated

Article No.	EAN 4003773-		Plug Ø mm	Cable mm ²	AWG	Colour	
97 99 130	076056	Round Sockets insulated	4.0	0.5 - 1	20 - 18	Red	100
97 99 131	076063	Round Sockets insulated	5.0	1.5 - 2.5	16 - 14	Blue	100



97 99 131

Round Pin Plugs

insulated

Article No.	EAN 4003773-		Plug Ø mm	Cable mm ²	AWG	Colour	
97 99 150	076070	Round Pin Plug insulated	4.0	0.5 - 1	20 - 18	Red	100
97 99 151	076087	Round Pin Plug insulated	5.0	1.5 - 2.5	16 - 14	Blue	100



97 99 151

Cable Connectors, eye type

insulated

> DIN 46237

Article No.	EAN 4003773-		Screws Ø mm	Cable mm ²	AWG	Colour	
97 99 170	076094	Cable Connectors, eye type insulated	3.0	0.5 - 1	20 - 18	Red	200
97 99 171	076100	Cable Connectors, eye type insulated	4.0	0.5 - 1	20 - 18		200
97 99 172	076117	Cable Connectors, eye type insulated	5.0	0.5 - 1	20 - 18		200
97 99 173	076124	Cable Connectors, eye type insulated	4.0	1.5 - 2.5	16 - 14	Blue	100
97 99 174	076131	Cable Connectors, eye type insulated	5.0	1.5 - 2.5	16 - 14		100
97 99 175	076148	Cable Connectors, eye type insulated	6.0	1.5 - 2.5	16 - 14		100
97 99 176	076155	Cable Connectors, eye type insulated	8.0	1.5 - 2.5	16 - 14		100
97 99 177	076162	Cable Connectors, eye type insulated	5.0	4 - 6	12 - 10	Yellow	100
97 99 178	076179	Cable Connectors, eye type insulated	6.0	4 - 6	12 - 10		100
97 99 179	076186	Cable Connectors, eye type insulated	8.0	4 - 6	12 - 10		100
97 99 180	076193	Cable Connectors, eye type insulated	10.0	4 - 6	12 - 10		100



97 99 170

Non-insulated Solderless Terminals

> DIN 46234

Article No.	EAN 4003773-		Screws Ø mm	Cable mm ²	AWG	
97 99 210	076209	Non-insulated Solderless Terminals	3.0	0.5 - 1	20 - 18	200
97 99 211	076216	Non-insulated Solderless Terminals	4.0	0.5 - 1	20 - 18	200
97 99 212	076223	Non-insulated Solderless Terminals	5.0	0.5 - 1	20 - 18	200
97 99 213	076230	Non-insulated Solderless Terminals	4.0	1.5 - 2.5	16 - 14	100
97 99 214	076247	Non-insulated Solderless Terminals	5.0	1.5 - 2.5	16 - 14	100
97 99 215	076254	Non-insulated Solderless Terminals	6.0	1.5 - 2.5	16 - 14	100
97 99 216	076261	Non-insulated Solderless Terminals	8.0	1.5 - 2.5	16 - 14	100
97 99 217	076278	Non-insulated Solderless Terminals	5.0	4 - 6	12 - 10	100
97 99 218	076285	Non-insulated Solderless Terminals	6.0	4 - 6	12 - 10	100
97 99 219	076292	Non-insulated Solderless Terminals	8.0	4 - 6	12 - 10	100
97 99 220	076308	Non-insulated Solderless Terminals	10.0	4 - 6	12 - 10	100



97 99 210

Heat Shrinkable Butt Connectors

Article No.	EAN 4003773-		Cable mm ²	AWG	Colour	
97 99 250	076315	Heat Shrinkable Butt Connectors	0.75 - 1	20 - 18	Red	100
97 99 251	076322	Heat Shrinkable Butt Connectors	1.5 - 2.5	16 - 14	Blue	100
97 99 252	076339	Heat Shrinkable Butt Connectors	4 - 6	12 - 10	Yellow	100



97 99 252

Butt Connectors, insulated

Article No.	EAN 4003773-		Cable mm ²	AWG	Colour	
97 99 270	076346	Butt Connectors, insulated	0.75 - 1	20 - 18	Red	100
97 99 271	076353	Butt Connectors, insulated	1.5 - 2.5	16 - 14	Blue	100
97 99 272	076360	Butt Connectors, insulated	4 - 6	12 - 10	Yellow	100



97 99 272

Butt Connectors, non-insulated

> DIN 46341-B

Article No.	EAN 4003773-		Cable mm ²	AWG	
97 99 290	076377	Butt Connectors, non-insulated	0.75 - 1	20 - 18	200
97 99 291	076384	Butt Connectors, non-insulated	1.5 - 2.5	16 - 14	200
97 99 292	076391	Butt Connectors, non-insulated	4 - 6	12 - 10	100
97 99 293	076407	Butt Connectors, non-insulated	10	8	100



97 99 290

Wire ferrules with plastic collar

Article No.	EAN 4003773		↔ mm	Cable mm ²	AWG	Colour	
97 99 330	076414	Wire ferrules with plastic collar	14.0	0.5	20	white	200
97 99 331	076421	Wire ferrules with plastic collar	14.0	0.75	18	grey	200
97 99 335	076469	Wire ferrules with plastic collar	17.0	4	12	grey	200
97 99 332	076438	Wire ferrules with plastic collar	14.0	1	18	Red	200
97 99 333	076445	Wire ferrules with plastic collar	14.0	1.5	16	black	200
97 99 334	076452	Wire ferrules with plastic collar	14.0	2.5	4	Blue	200
97 99 336	076476	Wire ferrules with plastic collar	20.0	6	10	Yellow	100
97 99 337	076483	Wire ferrules with plastic collar	22.0	10	8	Red	100
97 99 338	076490	Wire ferrules with plastic collar	24.0	16	6	Blue	100
97 99 339	076506	Wire ferrules with plastic collar	30.0	25	4	Yellow	50
97 99 350	076513	Wire ferrules with plastic collar	16.0	0.5	20	white	200
97 99 351	076520	Wire ferrules with plastic collar	16.0	0.75	18	grey	200
97 99 352	076537	Wire ferrules with plastic collar	16.0	1	17	Red	200
97 99 353	076544	Wire ferrules with plastic collar	16.0	1.5	16	black	200
97 99 354	076551	Wire ferrules with plastic collar	16.0	2.5	14	Blue	200
97 99 355	076568	Wire ferrules with plastic collar	20.0	4	12	grey	200
97 99 356	076575	Wire ferrules with plastic collar	26.0	6	10	Yellow	100
97 99 357	076582	Wire ferrules with plastic collar	28.0	10	8	Red	100
97 99 358	076599	Wire ferrules with plastic collar	28.0	16	6	Blue	100
97 99 359	076605	Wire ferrules with plastic collar	32.0	25	4	Yellow	50



97 99 353



97 99 336

Twin wire ferrules

with plastic collar

Article No.	EAN 4003773		↔ mm	Cable mm ²	AWG	Colour	
97 99 370	076612	Twin wire ferrules with plastic collar	15.0	2 x 0.5	2 x 20	white	200
97 99 371	076629	Twin wire ferrules with plastic collar	16.0	2 x 0.75	2 x 18	grey	200
97 99 372	076636	Twin wire ferrules with plastic collar	15.0	2 x 1	2 x 18	Red	200
97 99 373	076643	Twin wire ferrules with plastic collar	18.0	2 x 1.5	2 x 16	black	200
97 99 374	076650	Twin wire ferrules with plastic collar	18.0	2 x 2.5	2 x 14	Blue	100
97 99 375	076667	Twin wire ferrules with plastic collar	23.0	2 x 4	2 x 12	grey	100
97 99 376	076674	Twin wire ferrules with plastic collar	26.0	2 x 6	2 x 10	Yellow	50
97 99 377	076681	Twin wire ferrules with plastic collar	24.0	2 x 10	2 x 8	Red	50
97 99 378	076698	Twin wire ferrules with plastic collar	29.0	2 x 16	2 x 6	Blue	25



97 99 374

Non-insulated wire ferrules

> DIN 46228-1

Article No.	EAN 4003773		↔ mm	Cable mm ²	AWG	
97 99 390	076704	Non-insulated wire ferrules	6.0	0.5	20	200
97 99 391	076711	Non-insulated wire ferrules	6.0	0.75	18	200
97 99 392	076728	Non-insulated wire ferrules	6.0	1	18	200
97 99 393	076735	Non-insulated wire ferrules	7.0	1.5	16	200
97 99 394	076742	Non-insulated wire ferrules	7.0	2.5	14	200
97 99 395	076759	Non-insulated wire ferrules	9.0	4	12	200
97 99 396	076766	Non-insulated wire ferrules	12.0	6	10	100
97 99 397	076773	Non-insulated wire ferrules	12.0	10	8	100
97 99 398	076780	Non-insulated wire ferrules	12.0	16	6	100
97 99 399	076797	Non-insulated wire ferrules	12.0	25	4	50



97 99 390

Assortment Boxes

► Practical dispenser box, stackable and reclosable

- > Handy, transparent dispenser box
- > Rotating lid with opening to remove individual wire ferrules
- > Format: Ø 90 mm, height 44 mm



Article No.	EAN 4003773-	Quantity	Cable mm ²	AWG	Length of crimp area	↔ mm	Colour	Size	⚖ g
With insulated wire ferrules, with insulated wire ferrules by DIN colour code									
97 99 905	082446								70
		30	0.25	24	6.0	10.0		Ø 90 x 44	
		30	0.34	22	6.0	10.0		Ø 90 x 44	
		30	0.5	20	8.0	14.0	white	Ø 90 x 44	
		30	0.75	18	8.0	14.0	grey	Ø 90 x 44	
		30	1	18	8.0	14.0	red	Ø 90 x 44	
97 99 906	082453								95
		50	0.5	20	8.0	14.0	white	Ø 90 x 44	
		100	0.75	18	8.0	14.0	grey	Ø 90 x 44	
		100	1	18	8.0	14.0	red	Ø 90 x 44	
		100	1.5	16	8.0	14.0	black	Ø 90 x 44	
		50	2.5	14	8.0	14.0	blue	Ø 90 x 44	
97 99 907	082460								90
		50	4	12	10.0	17.0	grey	Ø 90 x 44	
		20	6	10	12.0	20.0	yellow	Ø 90 x 44	
		20	10	8	12.0	22.0	red	Ø 90 x 44	
		10	16	6	12.0	24.0	blue	Ø 90 x 44	
With Twin wire ferrules, with insulated wire ferrules by DIN colour code									
97 99 908	082477								95
		50	2 x 0.75	2 x 18	8.0	16.0	grey	Ø 90 x 44	
		50	2 x 1	2 x 18	8.0	15.0	red	Ø 90 x 44	
		50	2 x 1.5	2 x 16	10.0	18.0	black	Ø 90 x 44	
		50	2 x 2.5	2 x 14	9.0	18.0	blue	Ø 90 x 44	
97 99 909	082484								85
		20	4	2 x 12	12.0	23.0	grey	Ø 90 x 44	
		10	2 x 6	2 x 10	12.0	24.0	yellow	Ø 90 x 44	
		10	2 x 10	2 x 8	12.0	24.0	red	Ø 90 x 44	
		5	2 x 16	2 x 6	16.0	29.0	blue	Ø 90 x 44	
With non-insulated wire ferrules, rotating lid with opening to remove individual wire ferrules									
97 99 910	082491								145
		500	0.5	20		6.0		Ø 90 x 44	
		500	0.75	18		6.0		Ø 90 x 44	
		400	1	18		6.0		Ø 90 x 44	
		300	1.5	16		7.0		Ø 90 x 44	
		200	2.5	14		7.0		Ø 90 x 44	
97 99 911	082507								140
		150	4	12		9.0		Ø 90 x 44	
		75	6	10		12.0		Ø 90 x 44	
		75	10	8		12.0		Ø 90 x 44	
		50	16	6		12.0		Ø 90 x 44	

F-compression connector

- > Suitable for coax cable with outer diameter of 7 mm and dielectric from 4.7 mm diameter (all standard coax cable with Ø 1.1 mm inner conductor)
- > Nitin-6™ coating ensures excellent protection against environmental influences
- > Waterproof (8 h /at a depth of 30 m), ideal for connection to LNB and external antennae
- > Suitable for KNIPEX 97 40 20 compression tool
- > 10 Cablecon F-compression connectors in a blister pack



97 99 500

Article No.	EAN 4003773-	
97 99 500	082378	10

Insulated Tools



Pliers	202
Universal Tweezers	216
Cable Shears	216
Cable Cutters	218
Wire Rope and ACSR-Cable Cutters	221
Crimping Pliers	222
Wrenches	223
Nut Drivers	225
Screwdrivers	226
Sockets with Torx drive	230
T-handle	230
Reversible Ratchets	230
Extension Bars	231
Hexagon Sockets	231
Reversible Ratchet	233
Torque Wrenches	233
Cable Knives	234
Stripping Knives	234
Insulated Pliers of plastic	235
Insulating Clamp from plastic	236
Plastic Slip-On Caps	236
Electricians' Gloves	236
Self-Clamping Slip-On Caps	236
Insulating Mats	237
Stand Mats	237
PUK® Junior Hacksaw	237
Tool Kits	238





Testing dielectric strength, subjecting each pair of pliers to a load of 10,000 V AC.

Insulated tools are a matter of trust

Professionals trust their tools. This trust is vital when working on electrical installations. In this case, the electrician holding the pliers is also holding his life in his hands. Our insulated tools therefore not only meet statutory requirements, but also offer the greatest possible safety, reliability and performance.





Regulated by standards

Only trained professionals are allowed to work on live installations. Such work is subject to strict occupational health and safety standards such as the German DIN VDE 0105 and the international EN 50110 and IEC 60364. In each case they must deploy special tools that have been specifically manufactured and tested for this work. Which requirements have to be met by tools used in live work is determined by DIN EN / IEC 60900. KNIPEX tools which bear the special mark  1000 V are approved for work up to 1000 V AC.

Guaranteed individually checked

Every insulated tool undergoes, one by one, a dielectric strength at 10,000 V AC before we sell it. This means that work in the area up to 1,000 V AC has a safety buffer of ten times the permitted maximum limit. Other procedures check the reliability of the insulation towards heat, cold, tensile and impact force. In addition to the KNIPEX quality assurance team, external institutes and test centres such as the VDE guarantee that all VDE criteria have been satisfied. We go through this effort to safeguard the user. He trusts his well-being with our pliers, day in and day out. In return we want to give him the best possible safety at all times. We stand by this responsibility with our name on the insulation of KNIPEX tools.

Strong beneath the insulation

The insulation provides safety when handling electrical installations, but it does not cut, grip or crimp. The mechanical properties of the basic tool, such as cutting performance, precision and stability, therefore style part of the overall quality of insulated tools.

With our insulated pliers, users can depend on the quality and durability of products from KNIPEX production. For assembly tools insulated by us, we use basic tools from tried and tested suppliers whose quality we subject to regular, stringent checks. The expert can rely on this double dependability of tool and insulation.

Always comply with the currently valid regulations and observe the SAFETY INSTRUCTIONS given below:

- > Insulated tools must be transported in a manner that will prevent any damage to the insulation.
- > Check before every use whether the insulation is damaged in any way, defective tools must be discarded.
- > Always keep your insulated tools clean and dry.
- > Wear protective goggles when working with cutting nippers or working overhead.
- > Always wear goggles or a facial mask when working on live equipment.
- > Make sure the workplace is clean and orderly, particularly when you are working on live installations.
- > Wear protective clothing and use SAFETY equipment (e.g. insulating gloves, insulating mats, protective covers) especially in confined working spaces.
- > Use only a tool with suitable dimensions. That will prevent slipping on the workpiece and unintentional contact with non-insulated parts.
- > Make sure that detached parts or cut-off ends of conductors do not fall onto live parts.

Combination Pliers

Chrome Vanadium

- > For heavy duty
- > With gripping zones for flat and round material, suitable for versatile use
- > With cutting edges for soft, hard and piano wire
- > Long cutting edges for thicker cables
- > Cutting edges additionally induction-hardened, cutting edge hardness approx. 64 HRC
- > Particularly wear resistant gripping jaws; hardness of the gripping jaws approx. 53 HRC
- > Chrome vanadium heavy-duty steel, forged, multi stage oil-hardened
- > DIN ISO 5746, DIN EN 60900, IEC 60900



01 06 160

Article No.	EAN 4003773	↔ mm	1000 V	Pliers	Head	Handles	Cutting capacities				
							Ø mm	Ø mm	Ø mm	mm ²	Δ g
01 06 160	040729	160	1000 V	chrome plated	chrome plated	insulated with multi-component grips, VDE-tested	2.0	1.5	10.0	16	220
01 06 190	040415	190	1000 V				2.5	2.0	13.0	25	320

High Leverage Combination Pliers

- ▶ 35 % less effort required than with conventional combination pliers
- ▶ With cutting edges (hardness approx. 63 HRC) for heavy duty
- > Easier work due to optimised leverage
- > Easier cutting, powerful gripping, bending and pulling
- > Long cutting edges for thicker cables
- > With gripping zones for flat and round material, suitable for versatile use
- > Cutter head: special high-grade tool steel, forged, oil-hardened
- > DIN ISO 5746, DIN EN 60900, IEC 60900



02 06 180



02 07 225

Article No.	EAN 4003773	↔ mm	1000 V	Pliers	Head	Handles	Cutting capacities				
							Ø mm	Ø mm	Ø mm	mm ²	Δ g
02 06 180	010012	180	1000 V				2.5	2.0	11.5	16	247
02 06 200	010029	200	1000 V	chrome plated	chrome plated	insulated with multi-component grips, VDE-tested	2.8	2.2	13.0	25	343
02 06 225	010036	225	1000 V				3.0	2.5	14.0	25	425
02 07 200	022299	200	1000 V	chrome plated	chrome plated	with dipped insulation, VDE-tested	2.8	2.2	13.0	25	380
02 07 225	022305	225	1000 V				3.0	2.5	14.0	25	486

Combination Pliers

- > With gripping zones for flat and round material, suitable for versatile use
- > With cutting edges for soft and hard wire
- > Long cutting edges for thicker cables
- > Cutting edges additionally induction-hardened, cutting edge hardness approx. 60 HRC
- > Special tool steel, forged, multi stage oil-hardened
- > DIN ISO 5746, DIN EN 60900, IEC 60900

03 06 180 T*

> Pliers with tether attachment point for mounting a fall protection

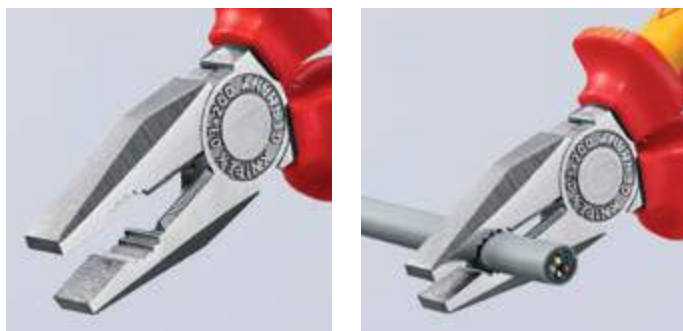

03 06 180



03 06 180 T



03 07 200

Article No.	EAN	↔ mm	1000V	Pliers	Head	Handles	Cutting capacities				
							Ø mm	Ø mm	Ø mm	mm ²	g
03 06 160	4003773	160					3.1	2.0	10.0	16	228
03 06 180	021902	180		chrome plated	chrome plated	insulated with multi-component grips, VDE-tested	3.4	2.2	12.0	16	264
03 06 200	033776	200		chrome plated	chrome plated	insulated with multi-component grips, VDE-tested	3.8	2.5	13.0	16	355
03 06 180 T	081395	180		chrome plated	chrome plated	insulated with multi-component grips with integrated insulated tether attachment point, VDE tested	3.4	2.2	12.0	16	270
03 07 160	015307	160					3.1	2.0	10.0	16	254
03 07 180	015314	180		chrome plated	chrome plated	with dipped insulation, VDE-tested	3.4	2.2	12.0	16	285
03 07 200	015321	200		chrome plated	chrome plated		3.8	2.5	13.0	16	339
03 07 250	015345	250					3.8	2.5	15.0	25	597



*Other tools with tethering can be found from page 272

Needle-Nose Combination Pliers

Small High Leverage Combination Pliers with pointed jaw. For all common installation and repair work.

- ▶ Handy use when working in confined areas thanks to slim head design and pointed jaws (anti-twist)
- ▶ Gripping surfaces with special convex contour on one side for secure gripping of flat parts
- ▶ Milled groove in the gripping area permits small parts such as nails, pins and bolts to be held and pulled

- > The reliable and diverse combination pliers when out and about
- > Easy cutting thanks to the high leverage joint
- > With cutting edges for soft, medium-hard and hard wire
- > Long service life and stable tips
- > Forged from special high grade tool steel, manifold oil-hardened
- > DIN ISO 5746, DIN EN 60900, IEC 60900

08 26 145 T*

- > Pliers with tether attachment point for mounting a fall protection



08 26 145



08 26 145 T

Article No.	EAN 4003773	↔ mm		Pliers	Head	Handles	Cutting capacities				g
							Ø mm	Ø mm	Ø mm	mm ²	
08 26 145	079361	145		chrome plated	chrome plated	insulated with multi-component grips, VDE-tested	3.0	2.0	8.0	16	145
08 26 145 T	081401	145		chrome plated	chrome plated	insulated with multi-component grips with integrated insulated tether attachment point, VDE tested	3.0	2.0	8.0	16	155

Insulation Strippers

universal

- > For single, multiple and fine stranded conductors with plastic or rubber insulation up to 5.0 mm dia. or 10 mm² cable cross-section
- > Easy adjustment to the required diameter of solid or stranded wire with knurled screw and lock nut
- > Special tool steel, forged, oil-hardened
- > DIN EN 60900, IEC 60900

11 06 160 T*

- > Pliers with tether attachment point for mounting a fall protection



11 06 160



11 07 160

Article No.	EAN 4003773-	↔ mm		Pliers	Head	Handles	Stripping capacities			g
							Ø mm	mm ²	AWG	
11 06 160	021933	160		chrome plated	chrome plated	insulated with multi-component grips, VDE-tested	5.0	10	8	200
11 06 160 T	081418	160		chrome plated	chrome plated	insulated with multi-component grips with integrated insulated tether attachment point, VDE tested	5.0	10	8	180
11 07 160	015499	160		chrome plated	chrome plated	with dipped insulation, VDE-tested	5.0	10	8	180
11 17 160	015505	160		chrome plated	chrome plated	with dipped insulation, VDE-tested	5.0	10	8	181
11 09 01	052326	Set of spare parts (screw and nut) for 11 160								

KNIPEX StriX®

PATENTED

Insulation strippers with Cable Shears – two essential electrical installation tools in one pair of pliers

- > Integrated Cable Shears for the clean cutting of Cu and Al cables without crushing
- > Universal adjustment of the wire stripping blades by means of a knurled screw
- > Slim design for good accessibility
- > For stripping single, multiple and fine stranded conductors with plastic and rubber insulation up to a max. Ø 5 mm or resp. 10 mm² conductor cross-section
- > Graduated jaw provides a visual orientation aid when stripping wire in standard lengths (11 mm and 16 mm)
- > Special high grade tool steel that has been oil-hardened in multiple stages

13 66 180 T*

- > Pliers with tether attachment point for mounting a fall protection



13 66 180



13 66 180 T



Induction hardened precision blade



Length marking: visual markings provide support during repeated stripping of wire in standard lengths (11 and 16 mm)



Induction hardened shear blade with precisely ground cutting edges for crushing-free cutting of copper cables up to Ø 15 mm (5 x 2.5 mm²)

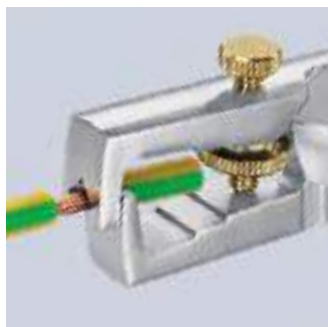

Lock nut prevents any unintentional adjustment



Article No.	EAN 4003773- 081302	↔ mm	Pliers	Head	Handles	Cutting capacities		Stripping capacities		⚖ g
						Ø mm	mm ²	Ø mm	mm ²	
13 62 180	081302	180	black atramentized	polished	with multi-component grips	15	50	5.0	10	210
13 66 180	081319	180	chrome plated		insulated with multi-component grips, VDE-tested	15	50	5.0	10	210



Stripping Pliers

Multifunctional – cutting and stripping with one pair of pliers

- ▶ For time-saving stripping of all round sheathed and damp-proof installation cables (e.g. NYM cable)
- ▶ Simplified access especially into deep mounted junction boxes thanks to slim head design and optimally angled cable sheath cutter
- ▶ Strip cables easily and without damage thanks to circular cutting edge with depth limiter

- > Suitable for universal use: precision wire stripping holes for conductors from 1.5 and 2.5 mm²
- > With side cutters for cutting and trimming conductors, wires, small screws and nails
- > All cutters additionally induction-hardened to approx. 61 HRC for high wear resistance
- > 30 % lighter than comparable pliers
- > Vanadium electric steel, forged, multi stage oil-hardened
- > DIN EN 60900, IEC 60900



13 46 165



Article No.	EAN 4003773-	↔ mm		Pliers	Head	Handles	Cable stripping values Ø mm	Stripping capacities mm ²	⊙ mm	⊙ mm	⚖ g
13 46 165	079699	165		chrome plated	chrome plated	insulated with multi-component grips, VDE-tested	8.0 - 13.0	0.75 - 1.5 / 2.5	3.2	2.2	190

Diagonal Insulation Strippers

- ▶ With long cutter
- ▶ High cutting capacity due to high leverage joint

- > Precision stripping holes for single conductors of 1.5 and 2.5 mm²
- > Convenient cutting of NYM cables up to 5 x 2.5 mm²
- > Long tips for ultra fine cutting work also in confined areas
- > Induction-hardened precision blades, cutting edge hardness approx. 60 HRC
- > Vanadium electric steel, forged, multi stage oil-hardened
- > DIN EN 60900, IEC 60900



14 26 160

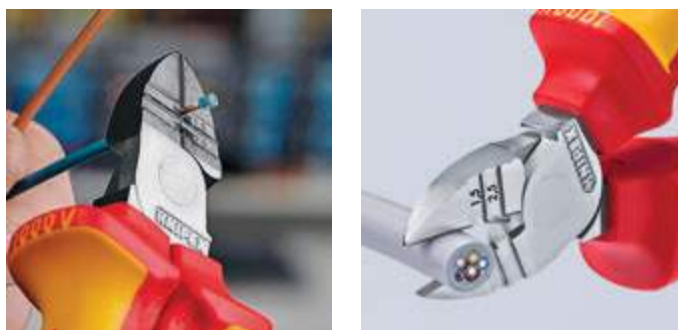

Article No.	EAN 4003773-	↔ mm		Pliers	Head	Handles	Stripping capacities mm ²	AWG	Cutting capacities		⚖ g
									⊙ mm	⊙ mm	
14 26 160	040279	160		chrome plated	chrome plated	insulated with multi-component grips, VDE-tested	1.5 / 2.5	16 / 14	2.5	1.5	216

Round Nose Pliers

- > For bending wire loops
- > Round, short jaws; finely ground
- > Smooth tips
- > Special tool steel, forged, oil-hardened
- > DIN ISO 5745, DIN EN 60900, IEC 60900

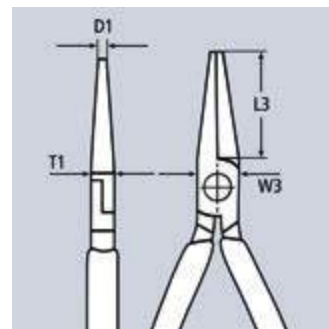
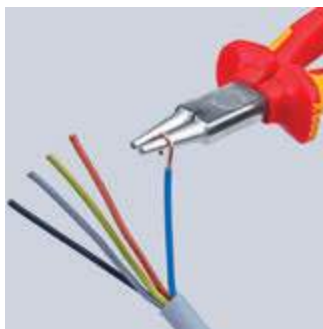

22 06 160

Article No.	EAN 4003773-	↔ mm	Pliers	Head	Handles	Dimensions				⚖ g	
						L3 mm	W3 mm	D1 mm	T1 mm		
22 06 160	033790	160	⚡ 1000 V	chrome plated	chrome plated	insulated with multi-component grips, VDE-tested	30.0	18.0	3.0	9.5	175

Pliers for Electrical Installation

PATENTED

The all-rounder for professionals

- ▶ 6 functions in one pair of pliers
- ▶ Multifunctional pliers for the electrical installation; to grip flat and round material, for bending, deburring, cutting cable, stripping and crimping wire ferrules

- > Smooth surfaces near the tips grip single cores without damaging them; serrated gripping surfaces and pipe grip for gripping flat and round material
- > Clear-cut outside edge on the jaw for working on flush-mounted junction boxes and deburring feed-through holes
- > Stripping holes for conductors of 0.75 - 1.5 mm² and 2.5 mm²
- > Crimping die for wire ferrules 0.5 - 2.5 mm²
- > Cable shears with (induction-hardened) precision cutting edges for copper and aluminium cables up to 5 x 2.5 mm² / dia. 15 mm
- > Slim dimensions for easy access
- > Bolted joint: precise, zero backlash operation of pliers
- > High-grade special tool steel, forged, multi stage oil-hardened
- > DIN EN 60900, IEC 60900



13 86 200



13 96 200



13 96 200 T

13 96 200

- > In case of models with opening spring integrated in the joint, the activated locking lever keeps the cutting edges closed while other functions remain active; the intelligent latching mechanism enables you to "grip" without opening the pliers. The cutting edge remains closed and protected

13 96 200 T*

- > Pliers with tether attachment point for mounting a fall protection



Article No.	EAN 4003773-	↔ mm	Pliers	Head	Handles	Cutting capacities		Stripping capacity for cross-sections mm ²	Crimping capacities mm ²	⚖ g	
						∅ mm	mm ²				
13 86 200	075097	200	⚡ 1000 V	chrome plated	chrome plated	insulated with multi-component grips, VDE-tested	15.0	50	0.75 - 1.5 / 2.5	0.5 - 2.5	280
13 96 200	075110	200	⚡ 1000 V	chrome plated	chrome plated	insulated with multi-component grips, VDE-tested	15.0	50	0.75 - 1.5 / 2.5	0.5 - 2.5	280
13 96 200 T	081425	200	⚡ 1000 V	chrome plated	chrome plated	insulated with multi-component grips with integrated insulated tether attachment point, VDE tested	15.0	50	0.75 - 1.5 / 2.5	0.5 - 2.5	275

Flat Nose Pliers

- > Flat, short, wide jaws
- > Knurled gripping surfaces
- > Special tool steel, forged, oil-hardened
- > DIN ISO 5745, DIN EN 60900, IEC 60900



20 06 160

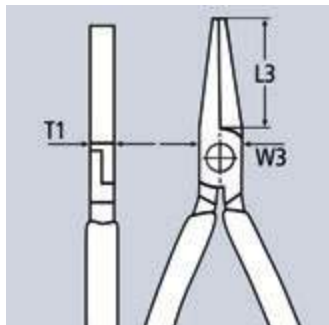

Article No.	EAN 4003773-	↔ mm		Pliers	Head	Handles	Dimensions			 g
							L3 mm	W3 mm	T1 mm	
20 06 160	033783	160		chrome plated	chrome plated	insulated with multi-component grips, VDE-tested	30.0	17.0	9.5	176

Snipe Nose Side Cutting Pliers

Radio Pliers

- > Suitable for finer gripping and cutting work
- > Half-round, long, tapered jaws
- > Knurled gripping surfaces
- > With cutting edges for soft, medium-hard and hard wire
- > Cutting edges additionally induction-hardened, cutting edge hardness approx. 61 HRC
- > Vanadium electric steel, forged, multi stage oil-hardened
- > DIN ISO 5745, DIN EN 60900, IEC 60900



25 06 160



25 26 160



Article No.	EAN 4003773-	↔ mm		Pliers	Head	Handles	Cutting capacities		 g
							 Ø mm	 Ø mm	
25 06 160	033806	160		chrome plated	chrome plated	insulated with multi-component grips, VDE-tested	2.5	1.6	146
25 06 160 T	081432	160		chrome plated	chrome plated	insulated with multi-component grips, VDE-tested, with integrated insulated tether attachment point for a tool tether	2.5	1.6	155
25 26 160	052111	160		chrome plated	chrome plated	insulated with multi-component grips, VDE-tested	2.5	1.6	144

Snipe Nose Side Cutting Pliers

Stork Beak Pliers

▶ Elastic tips: dimensionally stable even when twisted

- > Distortion-tolerant, elastic precision tips
- > Half-round, long, tapered jaws
- > With cutting edges (hardness approx. 61 HRC) for soft, medium-hard and hard wire
- > Vanadium electric steel, forged, multi stage oil-hardened
- > DIN ISO 5745, DIN EN 60900, IEC 60900

26 16 200 T / 26 26 200 T*

> Pliers with tether attachment point for mounting a fall protection

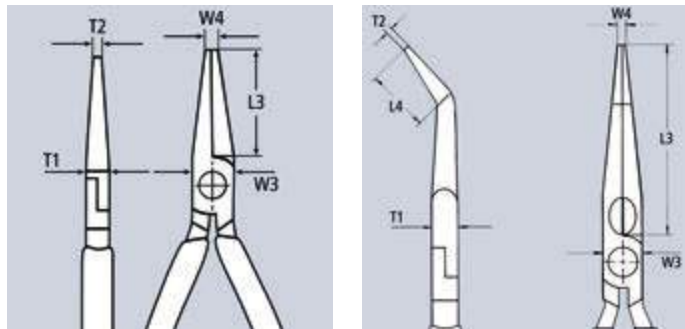

Article No.	EAN 4003773-	↔ mm		Pliers	Head	Handles	Cutting capacities		Dimensions						
							Ø mm	Ø mm	L3 mm	L4 mm	W3 mm	T1 mm	W4 mm	T2 mm	g
26 16 200	022831	200		chrome plated	chrome plated	insulated with multi-component grips, VDE-tested	3.2	2.2	73.0		18.0	9.5	3.0	2.5	206
26 16 200 T	081449	200		chrome plated	chrome plated	insulated with multi-component grips with integrated insulated tether attachment point, VDE tested	3.2	2.2	73.0		18.0	9.5	3.0	2.5	215
26 17 200	016069	200		chrome plated	chrome plated	with dipped insulation, VDE-tested	3.2	2.2	73.0		18.0	9.5	3.0	2.5	212
26 26 200	022855	200		chrome plated	chrome plated	insulated with multi-component grips, VDE-tested	3.2	2.2	73.0	23.0	18.0	9.5	3.0	2.5	204
26 26 200 T	081456	200		chrome plated	chrome plated	with multi-component grips and integrated tether attachment point	3.2	2.2	73.0	23.0	18.0	9.5	3.0	2.5	215
26 27 200	016090	200		chrome plated	chrome plated	with dipped insulation, VDE-tested	3.2	2.2	73.0	23.0	18.0	9.5	3.0	2.5	220

Long Nose Pliers

- > Heavy duty and wear resisting
- > Different jaw styles
- > Chrome vanadium electric steel, forged, oil-hardened
- > DIN ISO 5745, DIN EN 60900, IEC 60900

Style 1

- > Long, trapezoidal jaws; knurled gripping surfaces

Style 3

- > Long, round jaws; smooth gripping surfaces



30 16 160



30 36 160

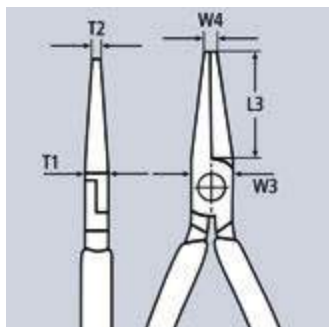

Article No.	EAN 4003773-	↔ mm		Style	Pliers	Head	Handles	Dimensions					Δ g
								L3 mm	W3 mm	T1 mm	W4 mm	T2 mm	
30 16 160	001904	160		1	chrome plated	chrome plated	insulated with multi-component grips, VDE-tested	46.5	16.5	9.5	3.0	5.0	150
30 36 160	002123	160		3	chrome plated	chrome plated	insulated with multi-component grips, VDE-tested	41.0	16.5	9.5	5.0	2.5	141

Diagonal Cutters

- > The indispensable diagonal cutter for all-round use
- > High-quality material and precise workmanship for long service life
- > Precision cutting edges for soft and hard wire
- > Clean cutting of thin copper wires, also at the cutting edge tips
- > Cutting edges additionally induction-hardened, cutting edge hardness approx. 62 HRC
- > Narrow head style for use in confined areas
- > Vanadium electric steel, forged, multi stage oil-hardened
- > DIN ISO 5749, DIN EN 60900, IEC 60900

70 06 160 T / 70 06 180 T*

- > Pliers with tether attachment point for mounting a fall protection



70 06 160



70 06 160 T



70 06 180



70 07 180



70 26 160



Clean cutting of thin copper wires, also at the cutting edge tips

Article No.	EAN 4003773-	↔ mm	Icons	Pliers	Head	Handles	Cutting capacities			
							⊘ mm	⊘ mm	⊘ mm	⚖ g
70 06 125	018124	125	⚡ 1000 V	chrome plated	chrome plated	insulated with multi-component grips, VDE-tested	3.0	2.3	1.5	121
70 06 140	040293	140	⚡ 1000 V	chrome plated	chrome plated	insulated with multi-component grips, VDE-tested	4.0	2.5	1.8	160
70 06 160	021995	160	⚡ 1000 V	chrome plated	chrome plated	insulated with multi-component grips, VDE-tested	4.0	3.0	2.0	216
70 06 160 T	081463	160	⚡ 1000 V	chrome plated	chrome plated	insulated with multi-component grips with integrated insulated tether attachment point, VDE tested	4.0	3.0	2.0	230
70 06 180	033813	180	⚡ 1000 V	chrome plated	chrome plated	insulated with multi-component grips, VDE-tested	4.0	3.0	2.5	254
70 06 180 T	081470	180	⚡ 1000 V	chrome plated	chrome plated	insulated with multi-component grips with integrated insulated tether attachment point, VDE tested	4.0	3.0	2.5	270
70 07 160	018155	160	⚡ 1000 V	chrome plated	chrome plated	with dipped insulation, VDE-tested	4.0	3.0	2.0	227
70 07 180	018179	180	⚡ 1000 V	chrome plated	chrome plated	with dipped insulation, VDE-tested	4.0	3.0	2.5	269
70 26 160	018223	160	⚡ 1000 V	chrome plated	chrome plated	insulated with multi-component grips, VDE-tested	4.0			216

KNIPEX X-Cut®

PATENTED

Compact Diagonal Cutters

high lever transmission

- ▶ Cuts finest strands as well as multi-core cables and piano wires
- ▶ Powerful, light and universal
- > High cutting performance with minimum effort due to optimum co-ordination of the cutting edge angle and transmission ratio
- > Box-joint design: highest stability with low weight
- > Doubly supported joint axis for heavy duty
- > Large opening width for thicker cables
- > Cuts precisely, even through fine copper wires
- > Compact, low-weight construction
- > Universally usable, in the assembly, maintenance and production
- > 40 % less force required compared with standard diagonal cutters of the same length
- > Chrome vanadium heavy-duty steel, forged, multi stage oil-hardened
- > DIN ISO 5749, DIN EN 60900, IEC 60900



73 06 160



73 06 160 T

40 % less effort

required compared to diagonal cutters of the same length. With double mounted hinged joint.

73 06 160 T*

> Pliers with tether attachment point for mounting a fall protection

Article No.	EAN 4003773-	↔ mm	Icons	Pliers	Head	Handles	Cutting capacities					
							Ø mm	Ø mm	Ø mm	Ø mm	Ø mm	Δ g
73 06 160	075141	160	Icons	chrome plated	chrome plated	insulated with multi-component grips, VDE-tested	4.8	3.8	2.7	2.2	12.0	175
73 06 160 T	081487	160	Icons	chrome plated	chrome plated	insulated with multi-component grips with integrated insulated tether attachment point, VDE tested	4.8	3.8	2.7	2.2	12.0	185

High Leverage Diagonal Cutters

- > For very tough, continuous use
- > High cutting performance with minimum effort due to optimum co-ordination of the cutting edge angle and transmission ratio
- > Precision cutting edges additionally induction-hardened (cutting edge hardness approx. 64 HRC), for all sorts of wire including piano wire
- > Chrome vanadium heavy-duty steel, forged, multi stage oil-hardened
- > DIN ISO 5749, DIN EN 60900, IEC 60900



74 06 200



74 06 200 T

20 % less effort

Required compared to high-leverage diagonal cutters of the same length. With integrated forged joint axle.

74 06 250 T*

> Pliers with tether attachment point for mounting a fall protection

Article No.	EAN 4003773-	↔ mm	Icons	Pliers	Head	Handles	Cutting capacities			Δ g
							Ø mm	Ø mm	Ø mm	
74 06 160	040705	160					3.4	2.5	2.0	215
74 06 180	022985	180					3.8	2.7	2.2	280
74 06 200	033820	200	Icons	chrome plated	chrome plated	insulated with multi-component grips, VDE-tested	4.2	3.0	2.5	304
74 06 250	041955	250					4.6	3.5	3.0	453
74 06 200 T	081494	200	Icons	chrome plated	chrome plated	insulated with multi-component grips with integrated insulated tether attachment point, VDE tested	4.2	3.0	2.5	305
74 06 250 T	081500	250	Icons	chrome plated	chrome plated	insulated with multi-component grips with integrated insulated tether attachment point, VDE tested	4.6	3.5	3.0	465
74 07 200	018414	200	Icons	chrome plated	chrome plated	with dipped insulation, VDE-tested	4.2	3.0	2.5	328
74 07 250	018421	250	Icons	chrome plated	chrome plated	with dipped insulation, VDE-tested	4.6	3.5	3.0	510

Pliers Wrenches

Pliers and a wrench in a single tool

- ▶ Replaces the need for sets of metric and imperial spanners
 - ▶ Smooth jaws for damage free installation of plated fittings – working directly on chrome!
 - ▶ Practical adjustment scale: A laser-cut (metric and imperial) enables pre-setting to the width across flats
- > Also excellent for gripping, holding, pressing and bending workpieces
- > Zero backlash jaw pressure prevents damage to edges of sensitive components
- > Fast adjustment by pushing a button directly on the workpiece
- > No unintentional shift of the gripping jaws and no slipping of the joint
- > Parallel jaws give a more solid grip; its design allows flexible adjustment of all widths up to the specified maximum size
- > The ratchet type principle allows quick and easy tightening and release of all bolted connections
- > Lever transmission greater than 10 : 1 for strong gripping power
- > Chrome vanadium electric steel, forged, oil-hardened
- > DIN EN 60900, IEC 60900



86 06 250

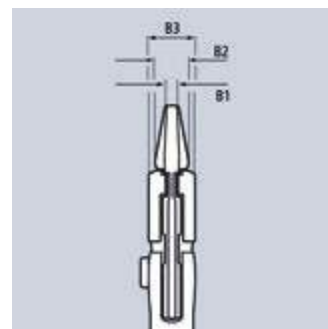

Article No.	EAN 4003773-	↔ mm	1000V	Pliers	Handles	Hex		Adjustment positions	Dimensions			Δ g
						Inch	mm		B1 mm	B2 mm	B3 mm	
86 06 250	082408	250	1000V	chrome plated	insulated with multi-component grips, VDE-tested	2	52.0	19	8.0	8.0	14.0	525

KNIPEX Alligator®

Water Pump Pliers

- ▶ Good access to the workpiece due to slim size of head and joint area
 - ▶ More output and comfort compared to conventional water pump pliers of the same length: 9-notch adjustment positioning for 30 % more gripping capacity
- > Self-locking on pipes and nuts: no slipping on the workpiece and low handforce required
- > Gripping surfaces with special hardened teeth, teeth hardness approx. 61 HRC: high wear resistance and stable gripping
- > Box-joint design for high stability due to double guide
- > Robust construction, insensitive to dirt; particularly suitable for outdoor work
- > Pinch guard prevents operators' fingers being pinched
- > Chrome vanadium electric steel, forged, multi stage oil-hardened
- > DIN ISO 8976, DIN EN 60900, IEC 60900



88 06 250



88 07 250



Article No.	EAN 4003773-	↔ mm	1000V	Pliers	Head	Handles	○	○	⬡	Adjustment positions	Δ g
							∅ Inch	∅ mm	mm		
88 06 250	039303	250	1000V	chrome plated	chrome plated	insulated with multi-component grips, VDE-tested	2	50.0	46.0	9	374
88 07 250	019343	250	1000V	chrome plated	chrome plated	with dipped insulation, VDE-tested	2	50.0	46.0	9	420
88 07 300	022350	300	1000V	chrome plated	chrome plated		2 3/4	70.0	60.0	9	661

KNIPEX Cobra® VDE

Hightech Water Pump Pliers, insulated

- > Adjustment by shifting one jaw directly on to the workpiece: fast, reliable and comfortable handling
- > Fine adjustment: allows optimum adjustment to differently sized workpieces and comfortable handle position
- > Good access to the workpiece due to slim size of head and joint area
- > Self-locking on pipes and nuts: no slipping on the workpiece and low handforce required
- > Gripping surfaces with special hardened teeth, teeth hardness approx. 61 HRC: high wear resistance and stable gripping
- > Box-joint design for high stability due to double guide
- > Pinch guard prevents operators' fingers being pinched
- > Chrome vanadium electric steel, forged, multi stage oil-hardened
- > DIN ISO 8976, DIN EN 60900, IEC 60900

87 26 250 T*

- > Pliers with tether attachment point for mounting a fall protection



87 26 250



87 26 250 T

The adjustment action to adapt to the workpiece is easy and reliable with the KNIPEX Cobra® VDE: place the upper gripping jaw of the opened pliers on the workpiece, push pliers to close, done!



Quick setting without using a push-button



Just push the pliers handle to adjust!

Article No.	EAN	↔ mm		Pliers	Head	Handles	⊘ Inch	⊘ mm	⬡ mm	Adjustment positions	⚖ g
87 26 250	071495	250		chrome plated	chrome plated	insulated with multi-component grips, VDE-tested	2	50.0	46.0	24	340
87 26 250 T	081517	250		chrome plated	chrome plated	insulated with multi-component grips, VDE-tested with integrated insulated tether attachment point for a tool tether	2	50.0	46.0	24	400
87 29 01	079002	range of spare parts for 87 2x-250									

*Other tools with tethering can be found from page 272

Universal Tweezers, insulated

DIN EN 60900, IEC 60900, tested protection against electrical voltage up to 1000 V

- > With insulated handles for working on electrical installations: safety up to 1000 V
- > For a wide range of requirements and applications in the electronics industry
- > Individually tested in accordance with 1000 V EN 60900 / IEC 60900 / VDE and approved for work with voltage up to 1000 Volts
- > The insulation is REACH-compliant and free from phthalates that are harmful to health
- > Antimagnetic to avoid electromagnetic damage
- > High quality stainless steel: extremely tough and very good corrosion resistance against a variety of atmospheric environments and many corrosive materials
- > Also available as a set (92 00 04)
- > Stainless steel

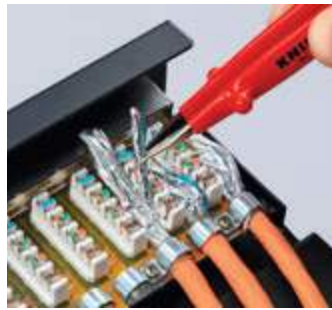

92 27 61

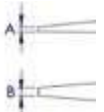

92 27 62

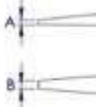

92 37 64



92 47 01



92 67 63



Article No.	EAN 4003773-	L x B x H mm		Handles	Finish	Tweezers tip version	Tips width A x B mm	⚖ g
92 27 61	054757	125 x 11 x 35	1000 V	smooth	straight	pointed	0,5 x 0,5	21
92 27 62	054764	150 x 8 x 40	1000 V	smooth	straight	pointed	1,0 x 1,3	22
92 37 64	054856	148 x 14 x 40	1000 V	smooth	30° bent	blunt	1,0 x 1,3	22
92 47 01	086963	142 x 16 x 38	1000 V	smooth	30° bent	blunt	1,3 x 3,0	29
92 67 63	054931	145 x 11 x 38	1000 V	smooth	straight	blunt	1,3 x 3,0	29

Cable Shears

handles extrusion plastic-coated

- > Not suitable for steel wire and hard drawn copper conductors
- > Precision-ground, hardened blades
- > No crushing, slight deformation of the cable only
- > Adjustable bolted joint
- > Shears body: surgical steel, stainless, vacuum-hardened
- > Handles: plastic, impact-proof
- > DIN EN 60900, IEC 60900

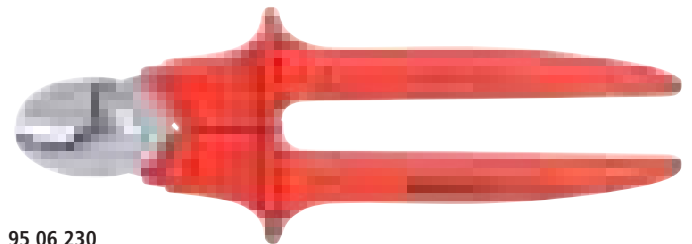

95 06 230

Article No.	EAN 4003773-	↔ mm		Head	Handles	Cutting capacities			⚖ g
						Ø mm	mm ²	AWG	
95 06 230	006305	230	1000 V	polished	plastic insulated, VDE-tested	16.0	50	1 / 0	274

Cable Shears

- > For cutting copper and aluminium single conductors as well as multiple stranded cables
- > Clean and smooth cut without crushing and deformation
- > Not suitable for steel wire and hard drawn copper conductors
- > Precision-ground, hardened blades
- > Easy cutting with one-hand operation
- > With guard
- > Adjustable bolted joint, self-retaining screw
- > High-grade special tool steel, forged, oil-hardened
- > DIN EN 60900, IEC 60900

95 16 165 T*

- > Pliers with tether attachment point for mounting a fall protection



95 16 165



95 26 165



Cutting a cable with a conventional wire cutter. High force is required, and the cable is squeezed and deformed.



Cut performed with a Cable Shear: easy, clean cut without any deformation of the cable



95 26 165: Catch locks shears to the opening spring inside



Article No.	EAN 4003773-	↔ mm	1000 V	Tool	Handles	Cutting capacities			⚖ g
						Ø mm	mm ²	AWG	
95 16 165	039648	165		chrome plated	insulated with multi-component grips, VDE-tested	15.0	50	1 / 0	262
95 16 165 T	081524	165		chrome plated	insulated with multi-component grips with integrated insulated tether attachment point, VDE tested	15.0	50	1 / 0	260
95 26 165	069980	165		chrome plated	insulated with multi-component grips, VDE-tested	15.0	50	1 / 0	275

Cable Shears

with twin cutting edge

- > For cutting copper and aluminium cables
- > Not suitable for steel wire and hard drawn copper conductors
- > Precision-ground, hardened blades
- > Clean and smooth cut without crushing and deformation
- > Adjustable bolted joint, self-retaining screw
- > Low handforce required due to favourable lever ratio and special blade geometry
- > Pinch guard prevents operators' fingers being pinched
- > By dividing the cutting actions into initial cut (insulating sheath in the front cutting area) and final cut (conductor in the back cutting area), cables up to Ø 20 mm can be cut in one-hand operation
- > High-grade special tool steel, forged, oil-hardened
- > DIN EN 60900, IEC 60900



95 16 200



Initial cut: using the front cutting edge to cut the insulating sheath on larger cable diameters leaves an ergonomic handle opening width.



Final cut: after cutting the sheath in the front profile the conductors in the rear part are cut. Initial cut in the front profile, final cut in the rear profile – to keep it as easy as possible.

Article No.	EAN 4003773-	↔ mm	1000 V	Tool	Handles	Cutting capacities			⚖ g
						Ø mm	mm ²	AWG	
95 16 200	026761	200		chrome plated	insulated with multi-component grips, VDE-tested	20.0	70	2 / 0	340
95 17 200	026952	200		chrome plated	with dipped insulation, VDE-tested	20.0	70	2 / 0	360

*Other tools with tethering can be found from page 272

Cable Shears

for two-handed use, short construction

- ▶ Short design, length only 500 mm
- ▶ Low weight, high leverage

- > For cutting copper and aluminium single conductors as well as multiple stranded cables
- > Not suitable for steel wire and wire ropes
- > Precision-ground, hardened blades
- > Clean and smooth cut without crushing and deformation
- > Low handforce required due to favourable lever ratio and special blade geometry
- > Pinch guard prevents operators' fingers being pinched
- > Adjustable bolted joint
- > Cutter head: vanadium electric steel, forged, oil-hardened
- > Handles: aluminium tube, high-strength
- > DIN EN 60900, IEC 60900



95 17 500



Large cutting capacity:
max. 27 mm dia. / 150 mm²

Article No.	EAN 4003773-	↔ mm		Head	Handles	Cutting capacities			⚖ g
						Ø mm	mm ²	AWG	
95 17 500	026785	500	⚡ 1000V	polished	with dipped insulation, VDE-tested	27.0	150	5 / 0	1477

Cable Shears

for two-hand operation

- > For cutting copper and aluminium single conductors as well as multiple stranded cables
- > Not suitable for steel wire and wire ropes
- > Precision-ground, hardened blades
- > Clean and smooth cut without crushing and deformation
- > Favourable lever ratio due to toggle lever
- > Pinch guard prevents operators' fingers being pinched
- > Adjustable bolted joint
- > Bolted cutter head, replaceable
- > Handles: steel tube
- > Cutter head: high-grade chrome vanadium electric steel, forged, oil-hardened
- > DIN EN 60900, IEC 60900



95 27 600

Article No.	EAN 4003773-	↔ mm		Head	Handles	Cutting capacities			⚖ g
						Ø mm	mm ²	AWG	
95 27 600	021797	600	⚡ 1000V	polished	with dipped insulation, VDE-tested	27.0	150	5 / 0	2262
95 29 600	021803	Spare cutter head for 95 21 600 / 95 27 600							

Cable Cutters

(ratchet action)

- > For cutting copper and aluminium single conductors as well as multiple stranded cables
- > Not suitable for steel wire and wire ropes
- > Precision-ground, hardened blades
- > Clean and smooth cut without crushing and deformation
- > One-hand operation using ratchet principle
- > Little handforce required due to very high transmission ratio
- > Two-stage ratchet drive for easy cutting
- > Simple handling as a result of low weight and compact design – can be used even in confined areas
- > Pinch guard prevents operators' fingers being pinched
- > High-grade special tool steel, forged, oil-hardened
- > DIN EN 60900, IEC 60900

95 36 280

- > Suitable for aluminium sector cable up to 4 x 150 mm²



95 36 250



95 36 280



Ratchet principle and two-stage ratchet drive for easier cutting



Article No.	EAN 4003773-	↔ mm		Tool	Handles	Cutting capacities			Δ g
						⊕ Ø mm	⊕ mm ²	MCM	
95 36 250	026884	250	⚡ 1000 V ⚡ M	black lacquered	insulated with multi-component grips, VDE-tested	32.0	240	500	652
95 36 280	026891	280	⚡ 1000 V ⚡ M	black lacquered	insulated with multi-component grips, VDE-tested	52.0	380	750	835
95 39 04	039167	Feed pawl 95 3 250/280							
95 39 08 S	039211	Tension spring set for lateral mounting 95 36 25/28							
95 39 250	022244	Movable spare blade for 95 31 250 / 95 36 250							
95 39 280	025283	Movable spare blade for 95 31 280 / 95 36 280							

Cable Cutters

(ratchet principle, 3-stage)

- ▶ Sturdy. Easy to use. Stable.
- ▶ Innovative ratchet-drive.
- ▶ For cable up to 60 mm diameter.

- > Fixed handle with support area for putting down the pliers when cutting
- > Easy handling due to low weight (825 g) and compact construction (320 mm length) – also usable in confined areas
- > Cutting through copper and aluminium cables with diameters of up to 60 mm in one-hand and two-hand operation
- > Hardened cutting edges, precisely ground, cut smoothly and neatly without crushing
- > For cutting copper and aluminium single conductors as well as multiple stranded cables (not suitable for steel wire and wire ropes)
- > Innovative three-stage ratchet-drive with high leverage for easy cutting in one-hand and two-hand operation
- > High-grade special tool steel, forged, oil-hardened
- > DIN EN 60900, IEC 60900



95 36 320

Article No.	EAN 4003773- 075189	↔ mm 320	1000V	Tool	Head	Handles	Cutting capacities			
							Ø mm	mm ²	MCM	g
95 36 320	075189	320		black atramentized	polished	insulated with multi-component grips, VDE-tested	60.0	600	1200	830
95 39 320 01	075714	Pivot cutter repair kit for 95 32 320 and 95 36 320								
95 39 320 02	075721	Fixed cutter repair kit for 95 32 320 and 95 36 320								

Cable Cutters

(ratchet action)

for steel wire armoured cables (SWA cable)

- ▶ Cuts through steel wire armoured cables with a diameter of up to 45 mm / 380 mm² (e.g. 4 x 95 mm²) using one or two-handed operation
- ▶ Sturdy. Easy to use. Stable.

- > Simple handling due to low weight (800 g) and compact design (315 mm length) – can also be used in confined areas
- > Precision-ground blades and induction-hardened cutting edges cut smoothly and neatly without crushing
- > Innovative high leverage three-stage ratchet-drive
- > Support area for putting down the pliers when cutting
- > Not suitable for cutting ACSR cable and wire rope!
- > Cutter head: special high-grade tool steel, forged, oil-hardened
- > IEC 60900, DIN EN 60900



95 36 315 A



Article No.	EAN 4003773- 078579	↔ mm 315	1000V	Tool	Handles	Cutting capacities				
						Ø mm	mm ²	MCM	g	
95 36 315 A	078579	315		black lacquered	insulated with multi-component grips, VDE-tested	45.0	380	750	800	
95 39 315 A01	078586	Pivot cutter repair kit for 95 32 315 A and 95 36 315 A								

Wire Rope and ACSR-Cable Cutters

Handles: aluminium, high-strength

- > For wire ropes and steel rods, copper and aluminium cables
- > Suitable for cutting overhead cables with strain relief wire (ACSR-cables)
- > Angular cutting blades allow cutting of single rope wire
- > Optimum transmission ratio for high cutting performance
- > Bolted cutter head, replaceable
- > Low weight
- > Handles: aluminium, high-strength
- > Cutter head: high-grade special tool steel, multi stage oil-hardened
- > DIN EN 60900, IEC 60900



95 77 600



Article No.	EAN 4003773-	↔ mm		Head	Handles	Cutting capacities			AWG	⚖ g
						⊕ mm ²	⊙ Ø mm	◐ Ø mm		
95 77 600	025313	600	⚡ 1000 V	polished	with dipped insulation	150	14.0	9.0	5 / 0	2359
95 79 600	025337	Spare cutter head for 95 71 600 / 95 77 600								

Crimping Pliers for wire ferrules with trapezoid crimp

- > For crimping wire ferrules according to DIN 46228 parts 1 + 4 in the range from 0.25 up to 2.5 mm²
- > Crimping in marked trapezoidal dies for reliable connections between the sleeve and the conductor
- > Vanadium electric steel; forged, oil-hardened
- > DIN EN 60900, IEC 60900



97 68 145 A

Article No.	EAN 4003773-	↔ mm			Head	Handles	Capacity mm ²	AWG	Δ g
97 68 145 A	071754	145			polished	insulated with multi-component grips, VDE-tested	0.25 - 2.5	24 - 14	175

Crimping Pliers for wire ferrules with mandrel crimp

- ▶ Light and slim design
- ▶ Easy crimping due to optimised transmission ratio

- > For crimping wire ferrules according to DIN 46228 parts 1 + 4 from 0.25 to 16 mm²
- > Crimping in marked half-round dies for reliable connections between the sleeve and the conductor
- > 9 particularly deep dies with conical side faces
- > Special tool steel, forged, oil-hardened
- > DIN EN 60900, IEC 60900

97 78 180 T*

- > Pliers with tether attachment point for mounting a fall protection



97 78 180



97 78 180 T



Article No.	EAN 4003773-	↔ mm			Head	Handles	Applications	Capacity mm ²	AWG	Δ g
97 78 180	072003	180			polished	insulated with multi-component grips, VDE-tested	Wire ferrules	0.25 - 16	24 - 6	254
97 78 180 T	081531	180			polished	insulated with multi-component grips, VDE-tested with integrated insulated tether attachment point for a tool tether	Wire ferrules	0.25 - 16	24 - 6	260



Open-end wrenches

- > Jaw 15° angled
- > Basic tool chrome plated
- > Chrome vanadium steel, forged, oil-hardened
- > DIN EN 60900, IEC 60900



98 00 14



Article No.	EAN 4003773-		Width across flats S mm	Width across flats S Inch	Length l max. mm	Head width b max. mm mm	Head thickness a max. mm	 g
98 00 07	019824		7,0		105,0	20,0	4,0	15
98 00 08	019831		8,0		105,0	22,0	4,0	31
98 00 09	019848		9,0		105,0	24,0	4,0	29
98 00 10	019893		10,0		105,0	27,0	5,0	46
98 00 11	019909		11,0		120,0	30,0	5,5	45
98 00 12	019923		12,0		125,0	32,0	5,5	70
98 00 13	019930		13,0		130,0	34,0	6,5	68
98 00 14	019947		14,0		135,0	35,0	6,5	86
98 00 15	019954		15,0		145,0	37,0	7,0	80
98 00 16	019961		16,0		155,0	38,0	7,0	112
98 00 17	019978		17,0		155,0	42,0	8,0	119
98 00 18	019985		18,0		160,0	44,0	8,0	149
98 00 19	019992		19,0		165,0	47,0	9,0	154
98 00 22	020004		22,0		190,0	52,0	9,0	216
98 00 24	020011		24,0		210,0	56,0	9,0	290
98 00 27	020028		27,0	1	215,0	63,0	9,0	307
98 00 1/4"	019886				108,0	20,0	4,0	32
98 00 5/16"	020073				108,0	22,0	4,0	36
98 00 3/8"	020042				108,0	27,0	5,0	37
98 00 7/16"	020097				120,7	30,0	5,5	53
98 00 1/2"	019879				139,7	34,0	6,5	70
98 00 9/16"	020110				152,4	35,0	6,5	102
98 00 5/8"	020080				165,1	38,0	7,0	124
98 00 3/4"	020035				190,5	47,0	9,0	164



Adjustable Wrench

- > Parallel smooth gripping jaws
- > Variable gripping width
- > With scaling for presetting the width apart from the workpiece
- > Chrome Vanadium steel
- > DIN EN 60900, IEC 60900



98 07 250



Article No.	EAN 4003773	↔ mm		Tool	Handle	⬡ mm	⬡ Inch	Jaw width mm	Head width mm	Width mm	Depth mm	⚖ g
98 07 250	071518	260	⚡ 1000V ∠22°	chrome plated	with dipped insulation	34.0	1 1/8	8.0	16.0	57.0	20.0	590

Box Wrenches

- > Cranked
- > Basic tool chrome plated
- > Chrome vanadium steel, forged, oil-hardened
- > DIN EN 60900, IEC 60900

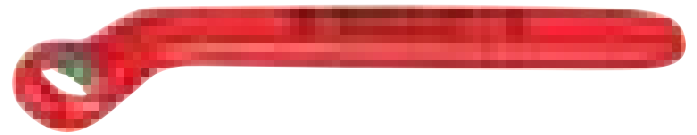

98 01 14



Article No.	EAN 4003773-		Width across flats S mm	Length l max. mm	Head width b max. mm mm	Head thickness a max. mm	Depth of crank h max. mm	⚖ g
98 01 07	020134	⚡ 1000V	7.0	150.0	12.0	7.0	18.0	55
98 01 08	020141		8.0	155.0	14.0	7.0	19.0	68
98 01 09	020158		9.0	165.0	15.5	8.0	19.0	78
98 01 10	020196		10.0	160.0	17.0	9.0	20.0	75
98 01 11	020202		11.0	165.0	18.5	10.0	21.0	93
98 01 12	020226		12.0	185.0	18.5	10.0	23.0	118
98 01 13	020233		13.0	185.0	21.5	11.0	23.0	125
98 01 14	020240		14.0	195.0	23.0	12.0	24.0	147
98 01 15	020257		15.0	200.0	24.0	12.0	24.0	143
98 01 16	020264		16.0	200.0	26.0	12.0	26.0	172
98 01 17	020271		17.0	205.0	27.0	13.0	26.0	184
98 01 18	020288		18.0	210.0	29.0	13.0	28.0	210
98 01 19	020295		19.0	225.0	30.0	14.0	28.0	245
98 01 22	020301		22.0	225.0	35.0	15.0	30.0	278
98 01 24	020318		24.0	265.0	38.0	16.0	30.0	415

Nut Drivers

with screwdriver handle

- > Ergonomically optimised dual component handle for fatigue reduced work and optimum transmission of force
- > Handle design prevents rolling
- > Chrome vanadium molybdenum steel
- > DIN EN 60900, IEC 60900



98 03 10

Article No.	EAN 4003773-	↔ mm		Tip	Handle	Width across flats S mm	Blade length mm	Handle length mm	Head dia. mm	⚖ g
98 03 04	071679	230		burnished	insulating multi-component handle, VDE-tested	4.0	125.0	107.0	9.0	70
98 03 05	071686	230				5.0	125.0	107.0	10.0	70
98 03 055	026082	232				5.5	125.0	107.0	11.0	87
98 03 06	026099	232				6.0	125.0	107.0	12.0	88
98 03 07	026105	237				7.0	125.0	112.0	14.0	123
98 03 08	024095	237				8.0	125.0	112.0	15.0	125
98 03 09	026112	237				9.0	125.0	112.0	16.0	129
98 03 10	026129	237				10.0	125.0	112.0	17.0	118
98 03 11	026136	237				11.0	125.0	112.0	19.0	148
98 03 12	026143	237				12.0	125.0	112.0	20.0	150
98 03 13	026150	237				13.0	125.0	112.0	21.0	152

Nut Drivers

with T-handle

- > Special tool steel, oil-hardened
- > DIN EN 60900, IEC 60900

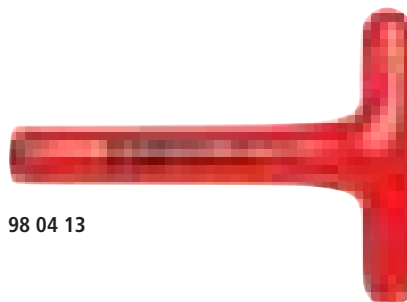

98 04 13



98 05 13

Article No.	EAN 4003773-	↔ mm		Width across flats S mm	Handle length mm	Head dia. mm	⚖ g
98 04 08	071341	200		8.0	90.0	15.0	344
98 04 10	026167	200		10.0	155.0	19.5	324
98 04 13	026198	200		13.0	155.0	23.5	344
98 04 17	026211	200		17.0	155.0	28.5	426
98 04 19	020424	200		19.0	155.0	31.0	525
98 04 22	026228	200		22.0	155.0	34.5	560
98 05 13	026273	300		13.0	155.0	23.5	409
98 05 17	026297	300		17.0	155.0	28.5	544
98 05 19	026303	300		19.0	155.0	31.0	674

Screwdrivers for hexagon socket screws

- > Ergonomically optimised dual component handle for fatigue reduced work and optimum transmission of force
- > Handle design prevents rolling
- > Chrome vanadium molybdenum steel
- > DIN EN 60900, IEC 60900



98 13 30

Article No.	EAN 4003773-	↔ mm		Tip	Handle	Width across flats S mm	Blade length mm	Length of non-insulated blade mm	Handle length mm	⚖ g
98 13 20	071693	175		burnished	insulating multi-component handle, VDE-tested	2.0	75.0	15.0	102.0	40
98 13 25	026334	177				2.5	75.0	15.0	102.0	32
98 13 30	026341	182				3.0	75.0	15.0	107.0	49
98 13 40	026358	182				4.0	75.0	15.0	107.0	55
98 13 50	026365	187				5.0	75.0	15.0	112.0	82
98 13 60	026372	212				6.0	100.0	15.0	112.0	98

Screwdrivers for hexagon socket screws

with T-handle

- > Special tool steel, oil-hardened
- > DIN EN 60900, IEC 60900

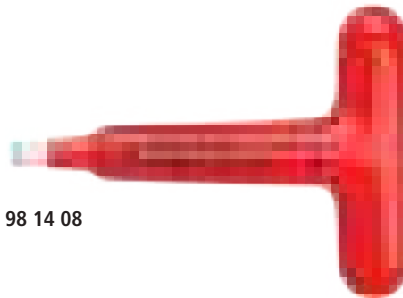

98 14 08

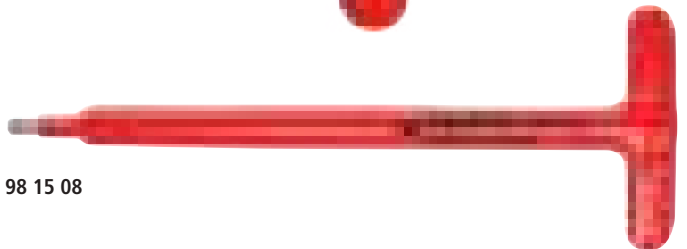

98 15 08

Article No.	EAN 4003773-	↔ mm		Width across flats S mm	Length of non-insulated blade ± 2 mm	T-Handle length mm	⚖ g
98 14 05	020431	120		5.0	9.0	90.0	220
98 14 06	020448	120		6.0	10.0	90.0	208
98 14 08	020455	120		8.0	11.0	90.0	286
98 15 05	020479	250		5.0	9.0	90.0	363
98 15 06	020486	250		6.0	10.0	90.0	452
98 15 08	020493	250		8.0	11.0	90.0	359

Screwdriver for slotted screws

- > Ergonomically optimised dual component handle for fatigue reduced work and optimum transmission of force
- > Handle design prevents rolling
- > Chrome vanadium molybdenum steel
- > DIN EN 60900, IEC 60900



98 20 55



98 21 45

Article No.	EAN 4003773-	↔ mm		Tip	Handle	Blade width mm	Blade thickness mm	Blade length mm	Length of non-insulated blade mm	Handle length mm	△△ g
98 20 10	026396	320	1000 V 	burnished	insulating multi-component handle, VDE-tested	10.0	1.6	200.0	15.0	120.0	184
98 20 25	062325	177				2.5	0.4	75.0	15.0	102.0	32
98 20 30	062332	202				3.0	0.5	100.0	15.0	102.0	35
98 20 35	024217	202				3.5	0.6	100.0	15.0	102.0	35
98 20 40	026402	202				4.0	0.8	100.0	15.0	102.0	38
98 20 55	024224	232				5.5	1.0	125.0	15.0	107.0	69
98 20 65	026419	262				6.5	1.2	150.0	15.0	112.0	105
98 20 80	024231	295				8.0	1.2	175.0	15.0	120.0	152
98 21 45	026426	287				4.5	0.8	180.0	15.0	107.0	66

Screwdrivers (Slim) for slotted screws

- > Reduced blade isolation diameter for recessed spring and screw elements
- > Ergonomically optimised dual component handle for fatigue reduced work and optimum transmission of force
- > Handle design prevents rolling
- > Chrome vanadium molybdenum steel
- > DIN EN 60900, IEC 60900



98 20 65 SL

Article No.	EAN 4003773-	↔ mm		Tip	Handle	Blade width mm	Blade thickness mm	Blade length mm	Length of non-insulated blade mm	Handle length mm	△△ g
98 20 35 SL	079712	202	1000 V 	burnished	insulating multi-component handle, VDE-tested	3.5	0.6	100.0	15.0	102.0	35
98 20 40 SL	079729	202				4.0	0.8	100.0	15.0	102.0	38
98 20 55 SL	079736	232				5.5	1.0	125.0	15.0	107.0	69
98 20 65 SL	079743	262				6.5	1.2	150.0	15.0	112.0	105

Screwdrivers for cross-recessed screws

Phillips®

- > Ergonomically optimised dual component handle for fatigue reduced work and optimum transmission of force
- > Handle design prevents rolling
- > Chrome vanadium molybdenum steel
- > DIN EN 60900, IEC 60900



98 24 03

Article No.	EAN 4003773-	↔ mm		Tip	Handle	Size	Blade length mm	Length of non-insulated blade mm	Handle length mm	△△ g
98 24 00	026433	162	1000 V 	burnished	insulating multi-component handle, VDE-tested	PH0	60.0	15.0	102.0	32
98 24 01	026440	187				PH1	80.0	15.0	107.0	58
98 24 02	026457	212				PH2	100.0	18.0	112.0	94
98 24 03	026464	270				PH3	150.0	18.0	120.0	165
98 24 04	026471	320				PH4	200.0	18.0	120.0	244

Screwdrivers (Slim) for cross-recessed screws

Phillips®

- > Reduced blade isolation diameter for recessed spring and screw elements
- > Ergonomically optimised dual component handle for fatigue reduced work and optimum transmission of force
- > Handle design prevents rolling
- > Chrome vanadium molybdenum steel
- > DIN EN 60900, IEC 60900



98 24 02 SL

Article No.	EAN 4003773-	↔ mm		Tip	Handle	Size	Blade length mm	Length of non-insulated blade mm	Handle length mm	⚖ g
98 24 01 SL	079750	187	⚡ 1000 V	burnished	insulating multi-component handle, VDE-tested	PH1	80.0	15.0	107.0	58
98 24 02 SL	079767	212	⚡ 1000 V	burnished	insulating multi-component handle, VDE-tested	PH2	100.0	18.0	112.0	94

Screwdrivers (Slim) Plus/Minus

Phillips®

- > Driving tips for PlusMinus profile screws
- > Use with electronics installation components, e.g. automatic circuit breakers
- > Reduced blade isolation diameter for recessed spring and screw elements
- > Ergonomically optimised dual component handle for fatigue reduced work and optimum transmission of force
- > Handle design prevents rolling
- > Chrome vanadium molybdenum steel
- > DIN EN 60900, IEC 60900



98 24 01 SLS

Article No.	EAN 4003773-	↔ mm		Tip	Handle	Size	Blade length mm	Length of non-insulated blade mm	Handle length mm	⚖ g
98 24 01 SLS	081036	187	⚡ 1000 V	burnished	insulating multi-component handle, VDE-tested	PH/S 1	80.0	15.0	107.0	56
98 24 02 SLS	081043	212	⚡ 1000 V	burnished	insulating multi-component handle, VDE-tested	PH/S 2	100.0	18.0	112.0	90

Screwdrivers for cross-recessed screws

Pozidriv®

- > Ergonomically optimised dual component handle for fatigue reduced work and optimum transmission of force
- > Handle design prevents rolling
- > Chrome vanadium molybdenum steel
- > DIN EN 60900, IEC 60900



98 25 03

Article No.	EAN 4003773-	↔ mm		Tip	Handle	Size	Blade length mm	Length of non-insulated blade mm	Handle length mm	⚖ g
98 25 00	062370	162	⚡ 1000 V	burnished	insulating multi-component handle, VDE-tested	PZ0	60.0	15.0	102.0	32
98 25 01	031260	187				PZ1	80.0	15.0	107.0	58
98 25 02	031277	212				PZ2	100.0	18.0	112.0	90
98 25 03	031284	270				PZ3	150.0	18.0	120.0	167
98 25 04	062387	320				PZ4	200.0	18.0	120.0	245

Screwdrivers (Slim) for cross-recessed screws

Pozidriv®

- > Reduced blade isolation diameter for recessed spring and screw elements
- > Ergonomically optimised dual component handle for fatigue reduced work and optimum transmission of force
- > Handle design prevents rolling
- > Chrome vanadium molybdenum steel
- > DIN EN 60900, IEC 60900



98 25 02 SL

Article No.	EAN 4003773-	↔ mm		Tip	Handle	Size	Blade length mm	Length of non-insulated blade mm	Handle length mm	⚖ g
98 25 01 SL	079774	187	⚠ 1000V	burnished	insulating multi-component handle, VDE-tested	PZ1	80.0	15.0	107.0	56
98 25 02 SL	079781	212	⚠ 1000V			PZ2	100.0	18.0	112.0	90

Screwdrivers for Torx® screws

- > Ergonomically optimised dual component handle for fatigue reduced work and optimum transmission of force
- > Handle design prevents rolling
- > Chrome vanadium molybdenum steel
- > DIN EN 60900, IEC 60900



98 26 30

Article No.	EAN 4003773-	↔ mm		Tip	Handle	Size	Blade length mm	Length of non-insulated blade mm	Handle length mm	⚖ g
98 26 10	071709	160	⚠ 1000V	burnished	insulating multi-component handle, VDE-tested	TX10	60.0	15.0	102.0	32
98 26 15	071716	185				TX15	80.0	15.0	107.0	58
98 26 20	071723	185				TX20	80.0	15.0	107.0	58
98 26 25	071730	185				TX25	80.0	15.0	107.0	58
98 26 30	071747	210				TX30	100.0	18.0	112.0	94

Sockets with Torx drive

3/8"

> DIN EN 60900, IEC 60900

Article No.	EAN 4003773-	↔ mm		Size	⚖ g
98 29 25	084600	123	⚡ 1000V	TX25	58
98 29 27	084617	123	⚡ 1000V	TX27	58
98 29 30	084624	123	⚡ 1000V	TX30	59
98 29 40	084631	123	⚡ 1000V	TX40	59
98 29 45	084648	117	⚡ 1000V	TX45	109
98 29 50	084655	117	⚡ 1000V	TX50	111



98 29 25



98 29 30



98 29 50

T-handle

with driving square 3/8" or 1/2"

- > For use with sockets
- > Quick, easy and reliable locking of attached sockets thanks to spring-loaded ball
- > Basic tool chrome plated
- > High-grade special tool steel, forged, oil-hardened
- > DIN EN 60900, IEC 60900

Article No.	EAN 4003773-	↔ mm		T-Handle Drive mm	Square drive Inch	⚖ g
98 30	026488	200	⚡ 1000V	165.0	3/8	447
98 40	026501	200	⚡ 1000V	165.0	1/2	631

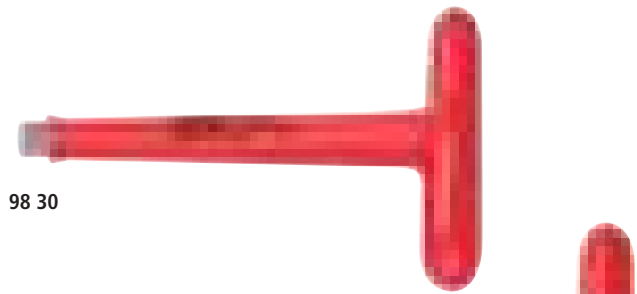

98 30



98 40

Reversible Ratchets

with driving square 3/8" or 1/2"

- > For use with sockets
- > Reversible for clockwise and anti-clockwise directions
- > Extremely smooth action
- > Quick, easy and reliable locking of attached sockets thanks to spring-loaded ball
- > Chrome vanadium steel, forged
- > DIN EN 60900, IEC 60900



98 31



98 41

Article No.	EAN 4003773-	↔ mm		Square drive Inch	⚖ g
98 31	026495	190	⚡ 1000V	3/8	324
98 41	026518	265	⚡ 1000V	1/2	625

Extension Bars

with internal and driving square 3/8" or 1/2"

- > For use with sockets
- > With internal and external square
- > Quick, easy and reliable locking of attached sockets thanks to spring-loaded ball
- > Chrome vanadium steel, forged
- > DIN EN 60900, IEC 60900



98 35 125



98 45 250

Article No.	EAN 4003773-	↔ mm		Square drive Inch	⚖ g
98 35 125	020530	125	⚡ 1000V	3/8	149
98 35 250	020547	250		3/8	294
98 45 125	020813	125	⚡ 1000V	1/2	258
98 45 250	020820	250		1/2	490

Hexagon Sockets for hexagonal socket screws

for internal square 3/8" or 1/2"

- > For metric and imperial hexagonal head screws
- > Basic tool chrome plated
- > Chrome Vanadium steel
- > DIN EN 60900, IEC 60900



98 37 17



98 47 17

Article No.	EAN 4003773-	↔ mm		Width across flats S mm	dia. of effective tool side d max. mm	Square drive Inch	⚖ g
98 37 10	020578	42	⚡ 1000V	10.0	18.7	3/8	32
98 37 11	020585	43		11.0	20.0	3/8	32
98 37 12	020608	44		12.0	21.2	3/8	33
98 37 13	020615	45		13.0	22.5	3/8	33
98 37 14	020622	46		14.0	23.7	3/8	39
98 37 16	027263	46		16.0	26.2	3/8	53
98 37 17	020639	46		17.0	27.5	3/8	61
98 37 19	020646	49		19.0	30.0	3/8	73
98 47 10	020882	54		⚡ 1000V	10.0	19.5	1/2
98 47 11	020899	54	11.0		20.7	1/2	61
98 47 12	020912	55	12.0		23.0	1/2	64
98 47 13	020929	55	13.0		23.2	1/2	64
98 47 14	020943	55	14.0		24.5	1/2	67
98 47 16	027287	55	16.0		26.9	1/2	69
98 47 17	020967	55	17.0		28.2	1/2	75
98 47 18	027294	55	18.0		29.0	1/2	81
98 47 19	020974	54	19.0		30.7	1/2	99
98 47 22	020981	58	22.0		34.5	1/2	125
98 47 24	020998	61	24.0		37.0	1/2	151
98 47 27	021001	63	27.0		41.0	1/2	183

12-Point Sockets

for internal square 3/8" or 1/2"

- > For imperial hexagonal head screws
- > Basic tool chrome plated
- > With double-hex
- > Chrome Vanadium steel
- > DIN EN 60900, IEC 60900



98 37 5



98 47 1



98 47 17

Article No.	EAN 4003773-	↔ mm		Width across flats S Inch	dia. of effective tool side d max. mm	Square drive Inch	⚖ g
98 37 5/16"	020684	42	⚡ 1000V	5/16	16.2	3/8	30
98 37 3/8"	020677	42		3/8	18.7	3/8	31
98 37 7/16"	020707	43		7/16	20.0	3/8	31
98 37 1/2"	020554	45		1/2	22.5	3/8	33
98 37 9/16"	020721	47		9/16	23.7	3/8	39
98 37 5/8"	020691	46		5/8	26.2	3/8	51
98 37 3/4"	020660	49		3/4	30.0	3/8	71
98 47 1/2"	020875	55		⚡ 1000V	1/2	23.2	1/2
98 47 9/16"	021094	55	9/16		24.5	1/2	64
98 47 5/8"	021063	55	5/8		26.9	1/2	72
98 47 11/16"	020905	55	11/16		28.2	1/2	88
98 47 3/4"	021018	55	3/4		30.7	1/2	97
98 47 7/8"	021087	58	7/8		34.5	1/2	124
98 47 1"	020868	61	1		41.0	1/2	167

Hexagon Sockets for hexagonal socket screws

for internal square 3/8" or 1/2"

- > For metric internal hexagonal head screws
- > Basic tool chrome plated
- > Special tool steel
- > DIN 7422, DIN EN 60900, IEC 60900



98 39 06

Article No.	EAN 4003773-	↔ mm		Width across flats S mm	Length of non-insulated blade ± 2 mm	Square drive Inch	⚖ g
98 39 05	020776	75	⚡ 1000V	5.0	9.0	3/8	59
98 39 06	020783	75		6.0	10.0	3/8	58
98 39 08	020790	75		8.0	11.0	3/8	71
98 49 05	021155	75	⚡ 1000V	5.0	9.0	1/2	68
98 49 06	021162	75		6.0	10.0	1/2	72
98 49 08	021179	75		8.0	11.0	1/2	87

Reversible Ratchet

with driving square 1/2"

- > Reversible for clockwise and anti-clockwise directions
- > Very reliable retention of the actuating tools ensured by mechanically locked retaining system
- > Chrome Vanadium steel
- > ISO 3315, DIN EN 60900, IEC 60900



98 42

Article No.	EAN 4003773-	↔ mm		Square drive Inch	⚖ g
98 42	026525	265	⚡ 1000 V	1/2	599

Torque Wrenches

with driving square, reversible

- > Reversible for tightening of lefthanded threads
- > Lockable torque adjustment
- > Easy and secure locking of attached sockets due to screw lock
- > Calibration certificate included
- > Adjustable in steps of 0.25 Nm
- > Chrome Vanadium steel
- > ISO 3315, DIN EN 60900, IEC 60900

98 33 50 / 98 43 50

- > Transparent insulated scale range 5 - 25 Nm

98 33 50 / 98 43 50

- > Transparent insulated scale range 5 - 50 Nm



98 33 25



98 33 50



98 43 50

Article No.	EAN 4003773-	↔ mm		Square drive Inch	⚖ g
98 33 25	072676	290	⚡ 1000 V ⚡	3/8	1230
98 33 50	071761	385		3/8	1230
98 43 50	071778	385	⚡ 1000 V ⚡	1/2	1230

Cable Knives

- > Ergonomically designed handle shape with comfortable slip guard
- > Particularly confident grip thanks to slip-proof soft components
- > Thumb recess and "finger hook" at the end of the handle ensure a good transmission of force when the blade is pulled
- > Solid, fixed straight blade
- > Transparent protective cap
- > Blade: special tool steel, oil-hardened
- > DIN EN 60900, IEC 60900

98 52

- > Back of the blade plastic coated to avoid short circuits



98 52



98 54

Article No.	EAN 4003773-	↔ mm		Handle	Blade length mm	⚖ g
98 52	035565	190	⚡ 1000V	insulating multi-component handle, VDE-tested	50.0	67
98 54	026563	190	⚡ 1000V	insulating multi-component handle, VDE-tested	50.0	68

Stripping Knives

with guide shoe

- > Ergonomically designed handle shape with comfortable slip guard
- > Particularly confident grip thanks to slip-proof soft components
- > Thumb recess and "finger hook" at the end of the handle ensure a good transmission of force when the blade is pulled
- > Transparent protective cap
- > DIN EN 60900, IEC 60900

98 53 03

- > Solid, fixed hook blade; suitable for round cables; blade: special tool steel, oil-hardened



98 53 03



98 53 13

98 53 13

- > Narrow, fixed hook blade, sickle shaped; suitable for sector cables; blade: special tool steel, oil-hardened



98 55

98 55

- > Solid, fixed hook blade, sickle shaped; with guide shoe at the blade point; no damage of the conductor insulation; blade: surgical steel, stainless, vacuum-hardened



Guide shoe 98 55

Article No.	EAN 4003773-	↔ mm		Handle	Blade length mm	Radius mm	⚖ g
98 53 03	026549	170	⚡ 1000V	insulating multi-component handle, VDE-tested	28.0	7.0	64
98 53 13	026556	190	⚡ 1000V	insulating multi-component handle, VDE-tested	50.0	40.0	64
98 55	022558	180	⚡ 1000V	insulating multi-component handle, VDE-tested	38.0	23.5	68

Cable Knives

with replaceable blade

- > Straight blade with special sharpening; replaceable
- > With hinged blade guard, integrated in the handle, captive
- > Back of the blade plastic coated to avoid short circuits
- > Ergonomically shaped insulating handle
- > Blade: surgical steel, stainless, vacuum-hardened
- > DIN EN 60900, IEC 60900



98 56

Article No.	EAN 4003773-	↔ mm		Blade length mm	⚖ g
98 56	026570	190	⚡ 1000V ⚠	50.0	64
98 56 09	030829	Spare blade for 98 56			

Plastic Flat Nose Pliers

insulating

- > Fully insulating to reduce risk of short circuit
- > For meter assembly and meter blocking
- > Class C; range of use up to -40°C
- > Plastic material, fibreglass-reinforced
- > Handles with soft plastic zone for better grip
- > DIN EN 60900, IEC 60900



98 62 01

Article No.	EAN 4003773-	↔ mm		⚖ g
98 62 01	073956	180	⚡ 1000V ⚠	120



Plastic Snipe Nose Pliers

insulating

- > Fully insulating to reduce risk of short circuit
- > Class C; range of use up to -40°C
- > Plastic material, fibreglass-reinforced
- > Handles with soft plastic zone for better grip
- > DIN EN 60900, IEC 60900



98 62 02

Article No.	EAN 4003773-	↔ mm		⚖ g
98 62 02	073963	220	⚡ 1000V ⚠	130



KNIPLEX presents high-quality and sturdy plastic pliers featuring protection against bridging for working on live parts up to AC 1000V and DC 1500V. These solid plastic pliers do not act on magnetic fields either and they are fully spark-free. They are also excellent for use in chemically aggressive environments.

Insulating Mats

from rubber

- > For added protection when working live or close to live parts
- > DIN/EN IEC 61112

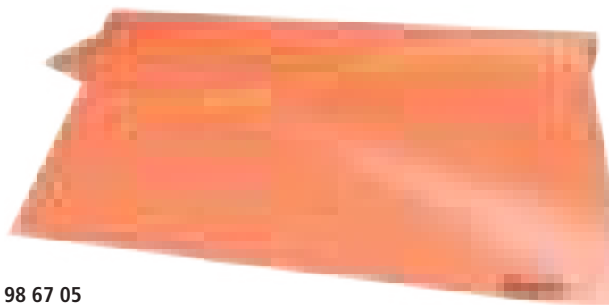

98 67 05

Article No.	EAN 4003773-		Dimensions mm	Thickness mm	⚖ g
98 67 05	026600	⚠ 1000V ⚡ ⚙	500 x 500 x 1 mm	1.0	301
98 67 10	026617		1000 x 1000 x 1 mm	1.0	820
98 67 15	077831		10000 x 1000 x 1 mm	1.0	12000

Stand Mats

from rubber

- > For site insulation when working live or close to live parts
- > IEC 61111



98 67 20

Article No.	EAN 4003773-		Dimensions mm	Thickness mm	⚖ g
98 67 20	077848	⚠ 1000V ⚡ ⚙	1000 x 1000 x 3 mm	3.0	3150
98 67 25	077855		10000 x 1000 x 3 mm	3.0	40000

PUK® Junior Hacksaw

- > Saw blade for metal and wood with 25 teeth per inch, exchangeable
- > DIN EN 60900, IEC 60900



98 90

Article No.	EAN 4003773-	↔ mm		Saw blade length	⚖ g
98 90	028321	240	⚠ 1000V	150.0	174
98 90 01	084358	Saw blades for PUK® saw 98 90			

Compact Tool Case

17 parts

▶ With insulated tools for works on electrical installations

- > Shock-resistant plastic case
- > Foam insert with precise recesses for holding the pliers
- > Equipped with a range of customary insulated KNIPEX tools for work on electrical systems
- > All tools are tested one by one and meet the requirements of IEC 60900
- > Dimensions, exterior (W x H x D): 380 x 85 x 260 mm
- > DIN EN 60900, IEC 60900



98 99 11

Article No.	EAN 4003773- 026624				Quantity	g ⚖
98 99 11			Compact Tool Case 17 parts			3675
		⚡ 1000 V	03 07 200	Combination Pliers	1	
		⚡ 1000 V	70 07 160	Diagonal Cutter	1	
			98 20 35		1	
		⚡ 1000 V	98 20 40	Screwdrivers for slotted screws	1	
			98 20 55		1	
		⚡ 1000 V	98 24 00	Screwdriver for cross recessed screws, Phillips®	1	
		⚡ 1000 V	98 42	Reversible Ratchet, with driving square 1/2"	1	
		⚡ 1000 V	98 45 125	Extension Bar, with internal/external square 1/2"	1	
			98 45 250		1	
			98 47 10	Hexagon Socket for hexagonal screws, with internal square 1/2"	1	
			98 47 11		1	
			98 47 12		1	
		⚡ 1000 V	98 47 13		1	
			98 47 14		1	
			98 47 17	1		
			98 47 19	1		
		⚡ 1000 V	98 52	Cable Knife	1	

























Compact Tool Case

26 parts

- ▶ With insulated tools for works on electrical installations
- > Shock-resistant plastic case
- > Foam insert with precise recesses for holding the pliers
- > Equipped with a range of customary insulated KNIPEX tools for work on electrical systems
- > Fixable partition wall
- > Dimensions, exterior (W x H x D): 440 x 105 x 385 mm



98 99 12

Article No.	EAN 4003773- 026631				Quantity	g ⚖
98 99 12				Standard Tool Case 26 parts		5533
		⚠ 1000V   	03 07 200	Combination Pliers	1	
		⚠ 1000V   	70 07 160	Diagonal Cutter	1	
			98 00 10	Open End Wrench	1	
			98 00 11		1	
			98 00 12		1	
		⚠ 1000V  	98 00 13		1	
			98 00 14		1	
			98 00 17		1	
			98 00 19	1		
		⚠ 1000V  	98 53 03	Dismantling Knife for round cables	1	
			98 20 25	Screwdrivers for slotted screws	1	
		⚠ 1000V   	98 20 35		1	
			98 20 40		1	
			98 20 55		1	
			98 24 00	Screwdriver for cross recessed screws,Phillips®	1	
		⚠ 1000V   	98 24 01		1	
			98 24 02	1		
		⚠ 1000V   	98 40	T-Handle Drive, with driving square 1/2"	1	
			98 47 10	Hexagon Socket for hexagonal screws, with internal square 1/2"	1	
			98 47 11		1	
			98 47 12		1	
		⚠ 1000V   	98 47 13		1	
			98 47 14		1	
			98 47 17		1	
			98 47 19	1		
		⚠ 1000V  	98 52	Cable Knife	1	

Tool Box "RED" Electro Set 1

Versatile use: the small four-piece VDE tool range in a handy case

- > High quality, versatile, shock-resistant plastic case
- > Foam insert with honeycomb structure for variable equipment
- > Dimensions, exterior (W x H x D): 340 x 56 x 275 mm

00 20 15

> Pliers VDE-tested according to DIN EN/IEC 60900 1000V

00 21 15 LE

> Box without tools



Article No.	EAN				Number	g
00 20 15	4003773-024804			Tool Box "RED" Electro-Set 1, 4 parts		1430
			03 06 180	Combination Pliers	1	
			11 06 160	Insulation Stripper	1	
			26 16 200	Snipe Nose Side Cutting Pliers (Stork Beak Pliers)	1	
			70 06 160	Diagonal Cutter	1	
00 21 15 LE	045175			Tool Box "RED", empty		530

Tool Box "RED" Electro Set 2

All you need, safely stored: seven-piece VDE tool set for electrical installation

- > High quality, versatile, shock-resistant plastic case
- > Foam insert with honeycomb structure for variable equipment
- > Dimensions, exterior (W x H x D): 340 x 56 x 275 mm

00 21 15

> All pliers and screwdrivers except Water Pump Pliers VDE-tested according to DIN EN/IEC 60900

00 21 15 LE

> Box without tools



Article No.	EAN				Number	Nominal size	g
00 21 15	4003773-042853			Tool Box "RED" Electro-Set 2, 7 parts			1520
			03 06 180	Combination Pliers	KNIPEX	180 mm	
			26 16 200	Snipe Nose Side Cutting Pliers (Stork Beak Pliers)		200 mm	
			70 06 160	Diagonal Cutter		160 mm	
			88 03 180	KNIPEX Alligator®, Water Pump Pliers		180 mm	
				Screwdrivers for slotted screws, 160i	Wera	0.4 x 2.5 x 80 mm	
				Screwdrivers for cross recessed Phillips® screws, 162i PH		0.8 x 4.0 x 100 mm	
				Screwdrivers for cross recessed Phillips® screws, 162i PH		PH1 x 80 mm	
00 21 15 LE	045175			Tool Box "RED", empty			530















Tool Roll

Essential for work on electrical systems: 15-piece basic tool kit in practical roll-up bag

- > Tool roll made of hard-wearing polyester fabric
- > With practical, adjustable quick release fastener
- > Equipped with a range of insulated KNIPEX tools for works on electrical installations
- > Dimensions, open (L x H): 830 x 310 mm



98 99 13

Article No.	EAN				Number	g
98 99 13	4003773-026648			Tool Roll, 15 parts		2455
		 1000 V 	03 07 200	Combination Pliers	1	
		 1000 V 	11 07 160	Insulation Stripper	1	
		 	26 17 200	Snipe Nose Side Cutting Pliers (Stork Beak Pliers)	1	
			70 07 160	Diagonal Cutter	1	
			95 17 200	Cable Shears with twin cutting edge	1	
			98 00 10		1	
			98 00 13		1	
		 1000 V 	98 00 14	Open-end wrench	1	
			98 00 17		1	
			98 00 19		1	
			98 20 25		1	
		 1000 V 	98 20 40	Screwdrivers for slotted screws	1	
			98 20 55		1	
			98 20 65		1	
		 1000 V 	98 52	Cable Knife	1	
98 99 13 LE	028888			Tool Roll, empty		325

Electronics Pliers and Precision Tweezers



Electronic Super Knips / ESD	244
Electronic Super Knips XL / ESD	246
Precision Electronics Diagonal Cutters / ESD	248
Electronics Diagonal Cutters / ESD	250
Electronics End Cutting Nippers / ESD	254
Electronics Oblique Cutting Nipper	255
Precision Electronics Gripping Pliers / ESD	256
Electronics Pliers / ESD	257
Electronics Mounting Pliers	259
Electronics Pliers Sets	260
Tweezer Sets	261
Precision Tweezers	262



Electronic Super Knips

- > Precision pliers for ultra fine cutting work, e. g. in electronics and fine mechanics
- > Ground, very sharp cutting edges without bevel
- > Precision shaped tips cut wires flush to a surface from $\varnothing 0.2$ mm.
- > Shear cut with controlled micro cutting edge misalignment for the most precise cutting of even the thinnest of wires and for a long service life
- > Joint with stainless steel rivet
- > Extremely smooth movement for minimum operator fatigue
- > With opening spring and opening limiter
- > Electrically discharging handles - dissipative
- > DIN ISO 9654

78 03 125/ESD / 78 23 125

- > INOX tool steel; cutting edge hardness approx. 54 HRC

78 13 125/ESD

- > INOX tool steel; cutting edge hardness approx. 54 HRC; with lead catcher – no uncontrolled loss of cut wire ends

78 31 125

- > Cutting edges additionally induction-hardened, cutting edge hardness approx. 60 HRC; with narrow head; special tool steel, burnished

78 41 125

- > With lead catcher - no uncontrolled loss of cut wire ends; with narrow head; cutting edges additionally induction-hardened, cutting edge hardness approx. 60 HRC; special tool steel, burnished

78 61 125/ESD

- > Also suitable for cutting glass fibre cables (fibre optics); cutting edges additionally induction-hardened, cutting edge hardness approx. 64 HRC; Special tool steel, oil hardened in multiple stages

78 71 125/ESD

- > With lead catcher – no uncontrolled loss of cut wire ends; cutting edges additionally induction-hardened, cutting edge hardness approx. 64 HRC; special tool steel, burnished



78 03 125



78 03 125 ESD



78 06 125



78 13 125



78 23 125



78 31 125



78 41 125

Models also for hard wire

78 81 125

- > Precision-ground cutting edges with very small bevel suitable also for hard wire; cutting edges additionally induction-hardened, cutting edge hardness approx. 64 HRC; special tool steel, burnished

78 91 125

- > Precision-ground cutting edges with very small bevel suitable also for hard wire; with lead catcher – no uncontrolled loss of cut wire ends; cutting edges additionally induction-hardened, cutting edge hardness approx. 64 HRC; special tool steel, burnished

ESD pliers (electrostatic discharge)

Electrostatic energy is discharged through the handles in a gradual and controlled manner. Which protects components endangered by electrostatic discharge. In accordance with applicable standards, e.g. IEC TR 61 340-5, DIN EN 61 340-5, SP Method 2472



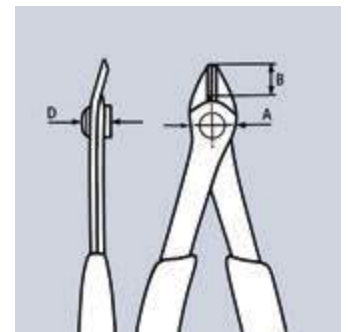
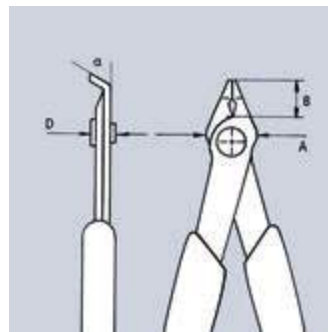
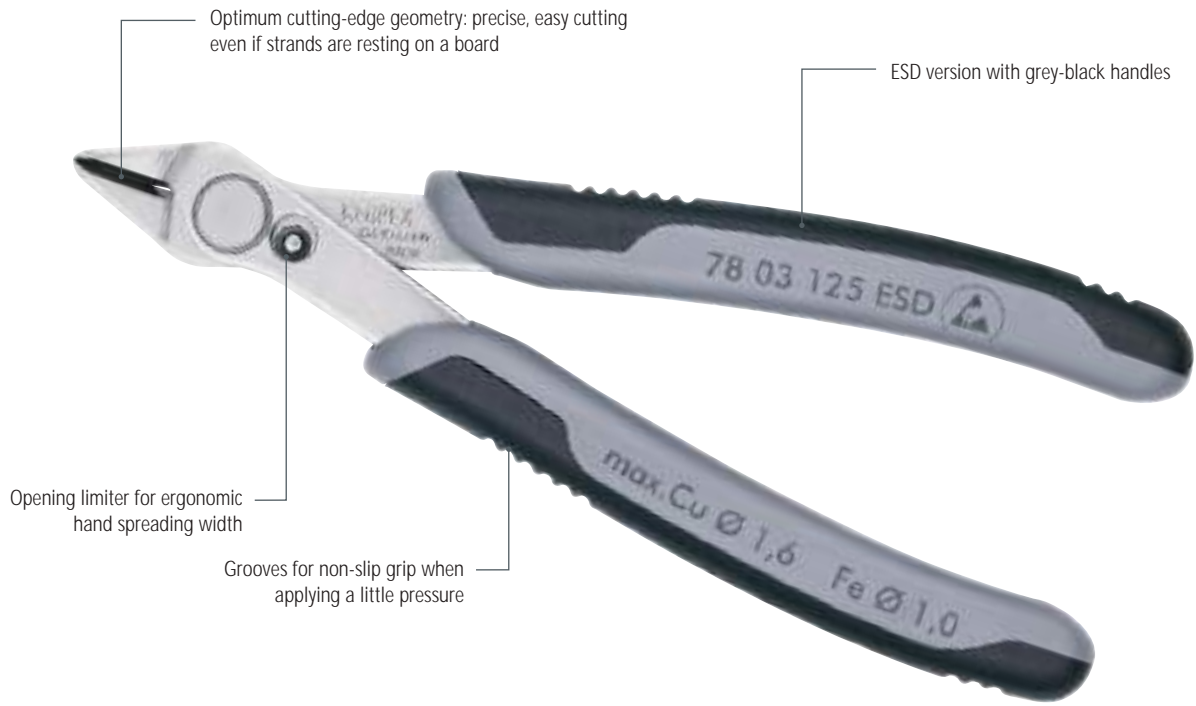

Article No.	EAN	↔ mm	Pliers	Head	Handles	Cutting capacities			Dimensions			
						Ø mm	Ø mm	Ø mm	B mm	A mm	D mm	g
78 03 125	035381	125	MM	polished	with multi-component grips	1.6	1.0		9.0	13.5	7.5	56
78 03 125 ESD	025146	125	MM	polished	with multi-component grips	1.6	1.0		9.0	13.5	7.5	55
78 06 125	084099	125	MM	polished	insulated with multi-component grips, VDE-tested	1.6	1.0		9.0	13.5	7.5	60
78 13 125	035398	125	MM	polished	with multi-component grips	1.6	1.0		9.0	13.5	7.5	57
78 13 125 ESD	025153	125	MM	polished	with multi-component grips	1.6	1.0		9.0	13.5	7.5	57
78 23 125	043096	125	MM	polished	with multi-component grips	1.0	0.6		5.5	13.5	7.5	55
78 31 125	039778	125	MM	burnished	with multi-component grips	1.0			9.0	12.5	7.5	55
78 41 125	040767	125	MM	burnished	with multi-component grips	1.0			9.0	12.5	7.5	57
78 61 125	035404	125	MM	burnished	with multi-component grips	1.6	1.2		9.0	13.5	7.5	56
78 61 125 ESD	025184	125	MM	burnished	with multi-component grips	1.6	1.2		9.0	13.5	7.5	56
78 71 125	043799	125	MM	burnished	with multi-component grips	1.6	1.2		9.0	13.5	7.5	57
78 71 125 ESD	025191	125	MM	burnished	with multi-component grips	1.6	1.2		9.0	13.5	7.5	57
78 81 125	065074	125	MM	burnished	with multi-component grips	1.6	1.2	0.6	9.0	13.5	7.5	57
78 91 125	065081	125	MM	burnished	with multi-component grips	1.6	1.2	0.6	9.0	13.5	7.5	57

Electronic Super Knips XL

- > For ultra fine cutting work, e.g. in electronics and fine mechanics
- > In particular for cutting cable ties to length
- > Ground, very sharp cutting edges without bevel
- > Shear cut with controlled micro cutting edge misalignment for the most precise cutting of even the thinnest of wires and for a long service life
- > Precision shaped tips cut wires flush to a surface from $\varnothing 0.2$ mm
- > Joint with stainless steel rivet
- > Extremely smooth movement for minimum operator fatigue
- > With opening spring and opening limiter
- > DIN ISO 9654



78 03 140



78 61 140







For flush cutting, e.g. for shortening cable ties

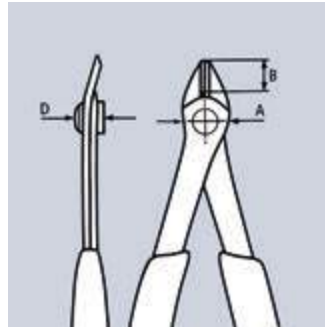

Shear cut with controlled micro cutting edge misalignment for the most precise cutting of even the thinnest of wires and for a long service life



Article No.	EAN 4003773-	↔ mm		Pliers	Head	Handles	Cutting capacities		Dimensions			
							 \varnothing mm	 \varnothing mm	B mm	A mm	D mm	Δ g
78 03 140	081647	140			polished	with multi-component grips	0.2 - 2.1	1.2	12.3	15.7	9.2	85
78 61 140	081685	140		burnished	burnished	with multi-component grips	0.2 - 2.1	1.4	12.3	15.7	9.2	85

Electronic Super Knips XL ESD

- > For ultra fine cutting work, e.g. in electronics and fine mechanics
- > Ground, very sharp cutting edges without bevel
- > Precision shaped tips cut wires flush to a surface from $\varnothing 0.2$ mm.
- > Shear cut with controlled micro cutting edge misalignment for the most precise cutting of even the thinnest of wires and for a long service life
- > Joint with stainless steel rivet
- > Extremely smooth movement for minimum operator fatigue
- > With opening spring and opening limiter
- > DIN ISO 9654, DIN EN 61 340-5

78 61 140 ESD

- > Cutting edge hardness approx. 64 HRC;
cutting edges additionally induction-hardened;
Special tool steel, oil hardened in multiple stages

78 03 140 ESD

- > Cutting edge hardness approx. 54 HRC;
INOX tool steel



78 03 140 ESD





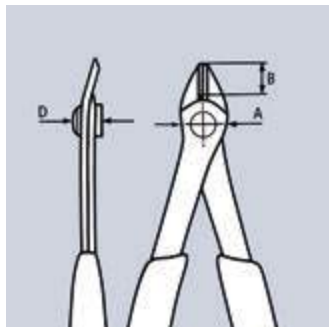







78 61 140 ESD



ESD pliers (electrostatic discharge)

Electrostatic energy is discharged through the handles in a gradual and controlled manner. Which protects components endangered by electrostatic discharge. In accordance with applicable standards, e.g. IEC TR 61 340-5, DIN EN 61 340-5, SP Method 2472



Article No.	EAN 4003773-	↔ mm		Pliers	Head	Handles	Cutting capacities		Dimensions			Δ g
							 \varnothing mm	 \varnothing mm	B mm	A mm	D mm	
78 03 140 ESD	081661	140	   		polished	with multi-component grips	0.2 - 2.1	1.2	12.3	15.7	9.2	77
78 61 140 ESD	081708	140	   	burnished	burnished	with multi-component grips	0.2 - 2.1	1.4	12.3	15.7	9.2	85

Precision Electronics Diagonal Cutters

- > Precision pliers for ultra fine cutting work, e. g. in electronics and fine mechanics
- > Very precisely ground and sharp cutting edges with very small bevels for exact cutting on delicate electronic components; also available without bevel for flush cutting
- > Cutting edges additionally induction-hardened, cutting edge hardness approx. 64 HRC
- > Approx. 20 % lighter than conventional electronics pliers
- > Bolted joint with carefully manufactured joint surfaces for even, low-friction movement throughout the entire opening range
- > Smooth-running double spring for a gentle and even opening
- > Ergonomically optimised multi-component handles
- > Ball bearing chrome steel, forged, multi stage oil-hardened
- > DIN ISO 9654

79 02 120 / 79 22 120

- > Mini-head

79 12 125

- > Specially for cutting through hard wire and piano wire

79 32 125 / 79 42 125

- > Pointed head

79 42 125 Z

- > For an optimised flush cutting result of soft materials

79 52 125 / 79 62 125

- > Pointed head; with lead catcher – no uncontrolled loss of cut wire ends



79 02 120



79 02 125



79 12 125



79 22 120



79 22 125



79 32 125

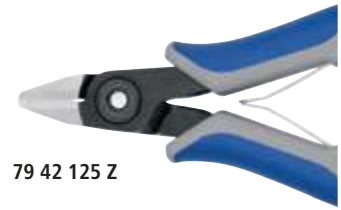

79 42 125 Z

Material catcher for 79 02 / 22 125 ESD see page 142

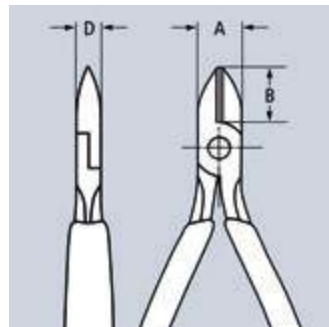

The subtle difference

KNIPLEX precision electronics pliers are made of high-quality ball bearing steel and processed with the highest degree of care. Each opening movement is gentle and even without backlash. Each work step proceeds reliably and precisely. This makes work much easier for professionals.

Article No.	EAN 4003773-	↔ mm	Icon	Pliers	Head	Handles	Cutting capacities				Dimensions			g
							Ø mm	Ø mm	Ø mm	Ø mm	B mm	A mm	D mm	
79 02 120	061403	120	Icon	burnished	polished	with multi-component grips	0.2 - 1.4	1.0	0.6		6.5	9.0	6.5	57
79 02 125	061281	125	Icon	burnished	polished	with multi-component grips	0.2 - 1.7	1.3	0.7		10.0	11.0	6.5	59
79 02 125 S1	071808	125	Icon	burnished	polished	with multi-component grips	0.2 - 1.7	1.3	0.7		10.0	11.0	6.5	59
79 12 125	071365	125	Icon	burnished	polished	with multi-component grips	0.3 - 1.7	1.3	1.0	0.6	10.0	11.0	6.5	59
79 22 120	061427	120	Icon	burnished	polished	with multi-component grips	0.1 - 1.3	0.8			6.5	9.0	6.5	56
79 22 125	061342	125	Icon	burnished	polished	with multi-component grips	0.1 - 1.7	1.0			10.0	11.0	6.5	60
79 32 125	061366	125	Icon	burnished	polished	with multi-component grips	0.2 - 1.5	1.1	0.6		11.0	11.0	6.5	58
79 42 125	061380	125	Icon	burnished	polished	with multi-component grips	0.1 - 1.5	0.8			11.0	11.0	6.5	58
79 42 125 Z	078449	125	Icon	burnished	polished	with multi-component grips	0.1 - 1.3				11.0	11.0	6.5	58
79 52 125	065135	125	Icon	burnished	polished	with multi-component grips	0.2 - 1.3	0.9	0.5		11.0	11.0	6.5	58
79 62 125	065142	125	Icon	burnished	polished	with multi-component grips	0.1 - 1.3	0.8			11.0	11.0	6.5	58

Precision Electronics Diagonal Cutters ESD

▶ Electrically discharging handles – dissipative

- > Precision pliers for ultra fine cutting work, e. g. in electronics and fine mechanics
- > Very precisely ground and sharp cutting edges with very small bevels for exact cutting on delicate electronic components; also available without bevel for flush cutting
- > Precision cutting edges additionally induction-hardened, cutting edge hardness approx. 64 HRC
- > Approx. 20 % lighter than conventional electronics pliers
- > Bolted joint with carefully manufactured joint surfaces for even, low-friction movement throughout the entire opening range
- > Smooth-running double spring for a gentle and even opening
- > Ergonomically optimised multi-component handles
- > Ball bearing chrome steel, forged, multi stage oil-hardened
- > DIN ISO 9654, DIN EN 61 340-5

79 02 120 ESD / 79 22 120 ESD

- > Mini-head

79 02 125 ESD / 79 22 125 ESD

- > Round head

79 12 125 ESD

- > Specially for cutting through hard wire and piano wire

79 32 125 ESD / 79 42 125 ESD

- > Pointed head



79 02 120 ESD



79 02 125 ESD



79 12 125 ESD



79 22 120 ESD



79 22 125 ESD



79 32 125 ESD



79 42 125 Z ESD

ESD pliers (electrostatic discharge)

Electrostatic energy is discharged through the handles in a gradual and controlled manner. Which protects components endangered by electrostatic discharge. In accordance with applicable standards, e.g. IEC TR 61 340-5, DIN EN 61 340-5, SP Method 2472

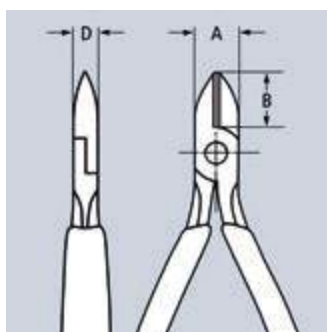

Article No.	EAN 4003773-	↔ mm		Pliers	Head	Handles	Cutting capacities				Dimensions			g	
							Ø mm	Ø mm	Ø mm	Ø mm	B mm	A mm	D mm		
79 02 120 ESD	061595	120			burnished	polished	with multi-component grips	0.2 - 1.4	1.0	0.6		6.5	9.0	6.5	60
79 02 125 ESD	061519	125			burnished	polished	with multi-component grips	0.2 - 1.7	1.3	0.7		10.0	11.0	6.5	61
79 12 125 ESD	071389	125			burnished	polished	with multi-component grips	0.3 - 1.7	1.3	1.0	0.6	10.0	11.0	6.5	61
79 22 120 ESD	061618	120			burnished	polished	with multi-component grips	0.1 - 1.3	0.8			6.5	9.0	6.5	61
79 22 125 ESD	061533	125			burnished	polished	with multi-component grips	0.1 - 1.7	1.0			10.0	11.0	6.5	61
79 32 125 ESD	061557	125			burnished	polished	with multi-component grips	0.2 - 1.5	1.1	0.6		11.0	11.0	6.5	61
79 42 125 ESD	061571	125			burnished	polished	with multi-component grips	0.1 - 1.5	0.8			11.0	11.0	6.5	58
79 42 125 Z ESD	078456	125			burnished	polished	with multi-component grips	0.1 - 1.3				11.0	11.0	6.5	58
79 52 125 ESD	065159	125			burnished	polished	with multi-component grips	0.2 - 1.3	0.9	0.5		11.0	11.0	6.5	58
79 62 125 ESD	065166	125			burnished	polished	with multi-component grips	0.1 - 1.3	0.8			11.0	11.0	6.5	58

Electronics Diagonal Cutters

- > Bolted joint for high precision and stress tolerance
- > For ultra fine cutting work, e.g. in electronics and fine mechanics
- > With sharp, ground cutting edges for soft and hard wire and piano wire
- > Cutting edges additionally induction-hardened, cutting edge hardness approx. 64 HRC
- > Low-friction double spring for gentle and even opening
- > High-grade special tool steel, forged, multi stage oil-hardened
- > DIN ISO 9654

Style 0

- > With bevel (outside bevel)

Style 2

- > With small bevel

Style 5

- > Particularly narrow head, with bevel



75 02 125



75 12 125



75 22 125



75 52 125



Bolted joint

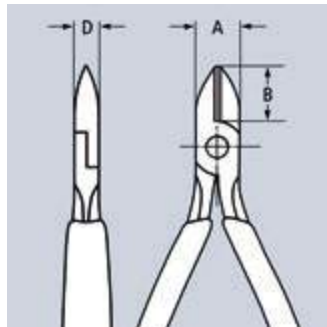

Article No.	EAN 4003773	↔ mm		Style	Pliers	Handles	Cutting capacities				Dimensions			△ g
							○ Ø mm	◐ Ø mm	◑ Ø mm	● Ø mm	A mm	B mm	D mm	
75 02 125	043720	125	🔪	0	burnished	with plastic grips	0.2 - 1.3	1.0	0.6	0.4	10.5	14.0	6.5	80
75 12 125	040514	125	🔪	1	burnished	with plastic grips	0.2 - 1.3	1.0	0.6	0.4	10.5	14.0	6.5	80
75 22 125	040538	125	🔪	2	burnished	with plastic grips	0.2 - 1.3	0.9	0.4	0.3	10.5	14.0	6.5	79
75 52 125	043737	125	🔪	5	burnished	with plastic grips	0.2 - 0.8	0.5	0.3		10.5	14.0	6.5	75

Electronics Diagonal Cutters

with box joint

- > For fine cutting work, e.g. in electronics and fine mechanics
- > Load-optimised for a more direct feel when working
- > Low-friction double spring for gentle and even opening
- > The mirror polish together with a fine film of oil offer effective rust protection – no circuit faults caused by peeling chrome from plated tools
- > Cutters additionally laser hardened, cutter hardness at least 60 HRC
- > Narrow sleeves pulled up to the head of the pliers enable the tool to be guided securely and comfortably, also between thumb and index finger
- > Sturdy, zero-backlash box joint
- > Ball bearing chrome steel, oil-hardened
- > DIN ISO 9654

77 01 115 / 77 02 130

- > Round head, with bevel; cutting edge hardness approx. 60 HRC

77 02 115 / 77 22 130

- > Round head, with small bevel; cutting edge hardness approx. 60 HRC

77 11 115 / 77 12 115

- > Round head, with bevel and lead catcher – no uncontrolled loss of cut wire ends; cutting edge hardness approx. 60 HRC

77 21 115

- > Round head, without bevel; cutting edge hardness approx. 60 HRC

77 22 115

- > Round head, without bevel; cutting edge hardness approx. 60 HRC

77 32 115

- > Pointed head, with small bevel; cutting edge hardness approx. 60 HRC

77 42 115 / 77 42 130

- > Pointed head, without bevel; cutting edge hardness approx. 60 HRC

77 52 115

- > Pointed, flat head, with small bevel; cutting edge hardness approx. 60 HRC

77 72 115

- > Pointed mini-head, with small bevel; cutting edge hardness approx. 60 HRC



77 01 115



77 02 115



77 02 130



77 12 115



77 22 115

Article No.	EAN	↔ mm	Head	Handles	Cutting capacities			Dimensions			
					Ø mm	Ø mm	Ø mm	B mm	A mm	D mm	Δ g
77 01 115	018568	115	mirror polished	plastic coated	0.3 - 1.6	1.2	0.6	14.0	11.0	7.5	50
77 01 130	018575	130	mirror polished	plastic coated	0.3 - 2.0	1.5	0.8	18.0	15.0	9.5	108
77 02 115	039334	115	mirror polished	with multi-component grips	0.3 - 1.6	1.2	0.6	14.0	11.0	7.5	70
77 02 130	039341	130	mirror polished	with multi-component grips	0.3 - 2.0	1.5	0.8	18.0	15.0	9.5	124
77 11 115	018629	115	mirror polished	with non-slip plastic coating	0.3 - 1.6	1.2	0.6	14.0	11.0	7.5	55
77 12 115	043768	115	mirror polished	with multi-component grips	0.3 - 1.6	1.2	0.6	14.0	11.0	7.5	70
77 21 115 N	082309	115	mirror polished	plastic coated	1.3	1.0			11.0		50
77 21 130	018667	130	mirror polished	plastic coated	0.3 - 1.6	1.3		18.0	14.0	9.5	110
77 22 115	043782	115	mirror polished	with multi-component grips	0.3 - 1.3	1.0		14.0	11.0	7.0	70
77 22 130	040446	130	mirror polished	with multi-component grips	0.3 - 2.0	1.5		18.0	15.0	9.0	124
77 32 115	044307	115	mirror polished	with multi-component grips	0.3 - 1.3	1.0	0.5	14.0	11.0	7.5	65
77 41 115	082316	115	mirror polished	with multi-component grips	1.3	0.8			11.0		50
77 42 115	039761	115	mirror polished	with multi-component grips	0.3 - 1.3	0.8		14.0	11.0	7.5	70
77 42 130	018773	130	mirror polished	with multi-component grips	0.3 - 1.6	1.3		18.0	15.0	9.5	122
77 52 115	040750	115	mirror polished	with multi-component grips	0.3 - 1.0	0.8	0.5	14.0	11.0	7.5	65
77 72 115	040958	115	mirror polished	with multi-component grips	0.3 - 0.8			10.5	11.0	6.0	65

Electronics Diagonal Cutters ESD

- > For fine cutting work, e.g. in electronics and fine mechanics
- > Electrically discharging handles – dissipative
- > Sturdy, zero-backlash box joint
- > Low-friction double spring for gentle and even opening
- > The mirror polish together with a fine film of oil offer effective rust protection – no circuit faults caused by peeling chrome from plated tools
- > Cutters additionally laser hardened, cutting edge hardness approx. 62 HRC
- > With two-colour dual component grips, black/grey
- > Ball bearing chrome steel, oil-hardened
- > DIN ISO 9654, DIN EN 61 340-5

77 02 115 ESD

- > Round head, with small bevel

77 12 115 ESD

- > Round head, with bevel and lead catcher – no uncontrolled loss of cut wire ends

77 22 115 ESD

- > Round head, without bevel

77 32 115 ESD

- > Pointed head, with small bevel

77 42 115 ESD

- > Pointed head, without bevel

77 52 115 ESD

- > Pointed, flat head, with small bevel

77 72 115 ESD

- > Pointed mini-head, with small bevel



77 02 115 ESD



77 12 115 ESD



77 22 115 ESD



77 32 115 ESD



77 42 115 ESD



77 52 115 ESD



77 72 115 ESD

ESD pliers (electrostatic discharge)

Electrostatic energy is discharged through the handles in a gradual and controlled manner. Which protects components endangered by electrostatic discharge. In accordance with applicable standards, e.g. IEC TR 61 340-5, DIN EN 61 340-5, SP Method 2472

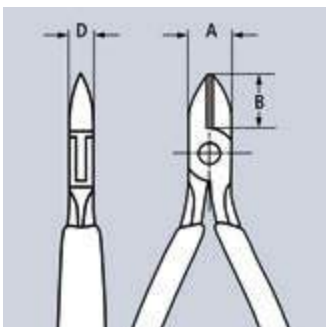

Article No.	EAN 4003773-	↔ mm		Head	Handles	Cutting capacities			Dimensions			
						☐ mm	● mm	◐ mm	B mm	A mm	D mm	Δ g
77 02 115 ESD	025092	115	☐ ▲ ▲ ▲ ▲ ▲	mirror polished	with multi-component grips	0.3 - 1.6	1.2	0.6	14.0	11.0	7.5	70
77 12 115 ESD	025108	115	☐ ▲ ▲ ▲ ▲ ▲	mirror polished	with multi-component grips	0.3 - 1.6	1.2	0.6	14.0	11.0	7.5	70
77 22 115 ESD	025115	115	☐ ▲ ▲ ▲ ▲ ▲	mirror polished	with multi-component grips	0.3 - 1.3	1.0		14.0	11.0	7.5	70
77 32 115 ESD	025122	115	☐ ▲ ▲ ▲ ▲ ▲	mirror polished	with multi-component grips	0.3 - 1.3	1.0	0.5	14.0	11.0	7.0	70
77 42 115 ESD	031901	115	☐ ▲ ▲ ▲ ▲ ▲	mirror polished	with multi-component grips	0.3 - 1.3	0.8		14.0	11.0	7.0	70
77 52 115 ESD	025139	115	☐ ▲ ▲ ▲ ▲ ▲	mirror polished	with multi-component grips	0.3 - 1.0	0.8	0.5	14.0	11.0	7.0	70
77 72 115 ESD	024330	115	☐ ▲ ▲ ▲ ▲ ▲	mirror polished	with multi-component grips	0.3 - 0.8			10.5	11.0	6.0	70

Electronics Diagonal Cutter

with inserted carbide metal cutting edges

- > For extreme demands on cutting pliers caused by hard or tough materials, e.g. piano, nickel, tungsten and diode wire, such as those used more frequently in the electronics and aerospace industries
- > Always the right cutting tool, even with the hardest material
- > Precision carbide metal cutting edges soldered into forged blanks
- > Sturdy, zero-backlash box joint
- > Hardness of the carbide cutting edges 80 - 83 HRC
- > Pliers with carbide metal cutting edges have a substantially longer service life than such with conventional cutting edges
- > Constantly reliable cutting results due to the avoidance of cutter deformations
- > High cost saving due to longer service life of the pliers
- > DIN ISO 9654

77 02 120 H / 77 02 135 H / ESD

- > Round head, with bevel

77 32 120 H / ESD

- > Pointed head with chamfer; with small bevel



77 02 120 H



77 02 120 H ESD



77 32 120 H



77 32 120 H ESD



Inserted carbide cutting edge

Precision carbide metal cutting edges soldered into forged blanks.



Article No.	EAN 4003773-	↔ mm		Head	Handles	Cutting capacities				Dimensions			Δ g
						○ Ø mm	◐ Ø mm	◑ Ø mm	● Ø mm	B mm	A mm	D mm	
77 02 120 H	075783	120	MM	mirror polished	with multi-component grips	2.0	1.4	1.0	0.6	14.0	11.0	7.5	85
77 02 135 H	075806	135	MM	mirror polished	with multi-component grips	2.2	1.6	1.2	0.8	18.0	15.0	9.5	115
77 02 120 H ESD	075813	120	MM	mirror polished	with multi-component grips	2.0	1.4	1.0	0.6	14.0	11.0	7.5	85
77 02 135 H ESD	075837	135	MM	mirror polished	with multi-component grips	2.2	1.6	1.2	0.8	18.0	15.0	9.5	115
77 32 120 H	075790	120	MM	mirror polished	with multi-component grips	1.6	1.0	0.6	0.2	14.0	11.0	7.5	80
77 32 120 H ESD	075820	120	MM	mirror polished	with multi-component grips	1.6	1.0	0.6	0.2	14.0	11.0	7.0	80

Electronics End Cutting Nippers

- > Precision pliers for ultra fine cutting work, e. g. in electronics and fine mechanics
- > Sturdy, zero backlash box joint
- > Low-friction double spring for gentle and even opening
- > The mirror polish together with a fine film of oil offer effective rust protection – no circuit faults caused by peeling chrome from plated tools
- > Cutters additionally laser hardened, cutting edge hardness at least 56 HRC
- > Ball bearing chrome steel, oil-hardened
- > DIN ISO 9654

Style 0

- > End Cutter, with small bevel

Style 2

- > End Cutter, mini-blade with small bevel

Style 3

- > Oblique End Cutter, short head, with small bevel, $\alpha = 15^\circ$

Style 4

- > Oblique End Cutter, short head, with small bevel, $\alpha = 27^\circ$

Style 5

- > Oblique End Cutter, short head, without bevel, for flush cutting, $\alpha = 27^\circ$

Style 6

- > Oblique End Cutter, mini-blade with small bevel, $\alpha = 65^\circ$

Style 7

- > Oblique End Cutter, mini-blade with small bevel, head with recess, $\alpha = 35^\circ$

Style 1 / 64 11 115

- > End Cutter, without bevel

Style 1 / 64 12 115 / ESD

- > End Cutter, with small bevel



64 01 115



64 02 115 ESD



64 11 115



64 12 115



64 22 115



64 32 120



64 11 115

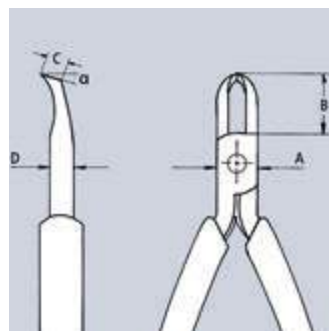

64 72 120



64 42 115



64 52 115

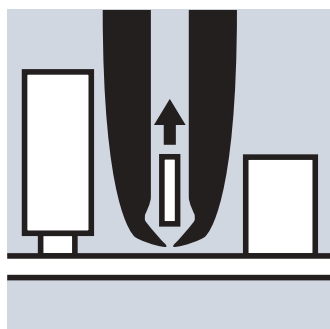

64 22 115

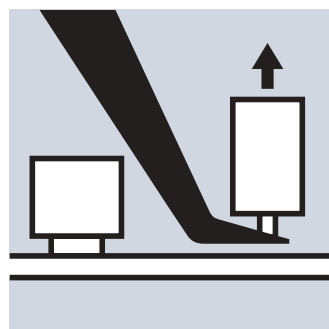

64 62 120



64 62 120



64 72 120

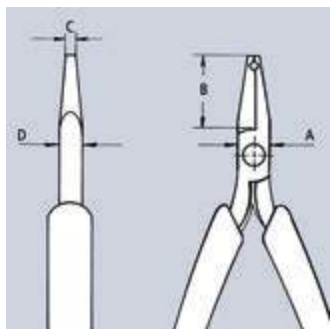

64 22 115

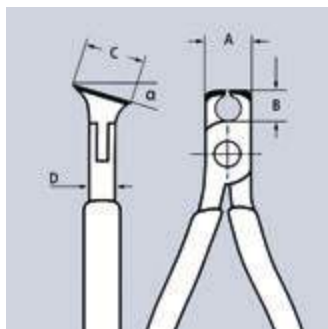

64 32/42/52

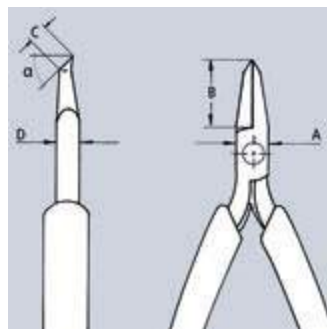

64 62 120

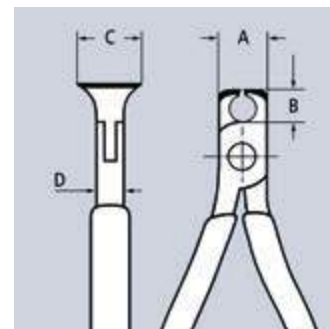

64 01/02/11/12

Article No.	EAN 4003773-	↔ mm	Style	Head	Handles	Cutting capacities			Dimensions				⚖ g	
						∅ mm	∅ mm	∅ mm	A mm	B mm	D mm	C mm		
64 01 115	017745	115	MM	0	mirror polished	with non-slip plastic coating	2.0	1.0	0.6	11.0	6.0	7.5	16.0	55
64 02 115	035343	115	MM	0	mirror polished	with multi-component grips	2.0	1.0	0.6	11.0	6.0	7.5	16.0	70
64 02 115 ESD	082231	130	∠90° MM	0	mirror polished	with multi-component grips	2.0	1.0	0.6	11.0	6.0	7.5	16.0	70
64 11 115	017769	115	MM	1	mirror polished	plastic coated	1.4	0.8		11.0	12.0	7.0	16.0	50
64 12 115	040743	115	MM	1	mirror polished	with multi-component grips	1.4	0.8	0.5	11.0	6.0	7.0	16.0	70
64 12 115 ESD	024323	115	∠90° MM	1	mirror polished	with multi-component grips	1.4	0.8		11.0	6.0	7.0	16.0	70
64 22 115	017806	115	MM	2	mirror polished	with multi-component grips	0.8			11.0	20.0	6.0	3.0	70
64 22 115 ESD	025061	115	MM	2	mirror polished	with multi-component grips	0.8			11.0	20.0	6.0	3.0	70
64 32 120	017820	120	∠15° MM	3	mirror polished	with multi-component grips	1.5	1.0	0.5	11.0	10.0	7.0	17.0	70
64 32 120 ESD	025078	120	∠15° MM	3	mirror polished	with multi-component grips	1.5	1.0	0.5	11.0	10.0	7.0	17.0	70
64 42 115	017844	115	MM	4	mirror polished	with multi-component grips	1.5	1.0	0.5	11.0	10.0	7.0	12.0	70
64 52 115	040439	115	∠27° MM	5	mirror polished	with multi-component grips	1.3			11.0	10.0	7.0	12.0	70
64 62 120	046998	120	∠65° MM	6	mirror polished	with multi-component grips	0.6			11.0	20.0	7.0	7.0	70
64 62 120 ESD	025085	120	∠65° MM	6	mirror polished	with multi-component grips	0.6			11.0	20.0	7.0	7.0	70
64 72 120	017882	120	∠35° MM	7	mirror polished	with multi-component grips	1.5			11.0	20.0	7.0	6.0	70

Electronics Oblique Cutting Nipper

- > With cutting edges for soft and medium hard wire
- > Without bevel, for flush cutting
- > Cutters additionally laser hardened, cutting edge hardness approx. 56 HRC
- > Low-friction double spring for gentle and even opening
- > Sturdy, zero backlash box joint
- > The mirror polish together with a fine film of oil offer effective rust protection – no circuit faults caused by peeling chrome from plated tools
- > Ball bearing chrome steel, oil-hardened
- > DIN ISO 9654



62 12 120

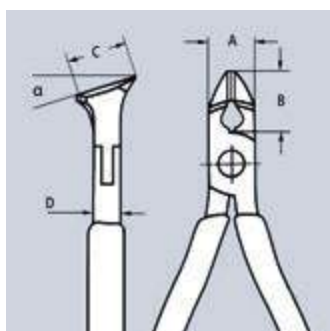

Article No.	EAN 4003773-	↔ mm	Style	Handles	Cutting capacities		Dimensions				⚖ g
					∅ mm	∅ mm	A mm	B mm	C mm	D mm	
62 12 120	048008	120	∠15° MM	with multi-component grips	0.3 - 1.0	0.7	11.0	10.0	17.0	7.5	70

Precision Electronics Gripping Pliers

- > The assortment for highest standard of performance and results
- > Precision pliers for fine assembly work, e.g. in electronics and fine mechanics
- > For gripping, holding and bending
- > Bolted joint: precise, zero backlash operation of pliers
- > Precisely finished joint surfaces for smooth, low friction movement along the complete opening range
- > Low-friction double spring for gentle and even opening
- > Smooth ground gripping surfaces, edges carefully deburred
- > Non-reflective finish
- > Low weight
- > For very precise assembly work, e.g. in electronics and fine mechanics
- > Smoothly ground gripping surfaces, edges finely rounded
- > Approx. 20 % lighter than conventional electronics pliers
- > Bolted joint and carefully manufactured joint surfaces for even, low-friction movement throughout the entire opening range
- > Smooth-running double spring for a gentle and even opening
- > With precision laser cut cross-shaping
- > Ball bearing chrome steel, forged, multi stage oil-hardened
- > DIN ISO 9655

Style 1

- > Flat, wide jaws

Style 2

- > Half-round jaws

Style 3

- > Round, pointed jaws

Style 4

- > Flat, wide jaws, with precision laser cut cross-shaping

Style 5

- > Half-round jaws, with precision laser cut cross-shaping



34 12 130 ESD



34 12 130



34 22 130



34 22 130 ESD



34 32 130



34 32 130 ESD



34 42 130



34 42 130 ESD

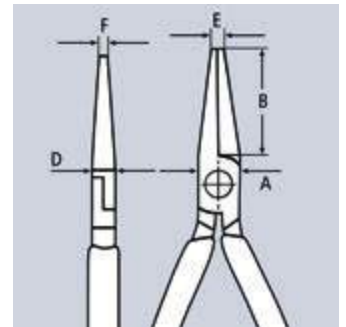
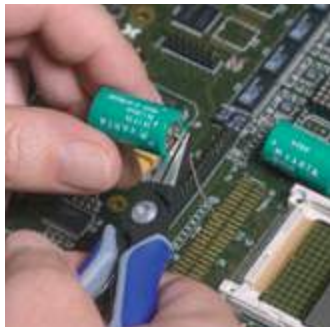

Cross-shaping: precision laser cut for a secure grip in ultra fine mounting work

Article No.	EAN 4003773-	↔ mm	Jaw Profile	Head	Handles	Dimensions					⚖ g
						B mm	A mm	D mm	E mm	F mm	
34 12 130 ESD	061632	135	Flat, wide	polished	with multi-component grips	21.9	11.2	6.5	1.4	3.5	62
34 12 130	061458	135	Flat, wide	polished	with multi-component grips	21.9	11.2	6.5	1.4	3.5	61
34 22 130	061472	135	Half-round	polished	with multi-component grips	22.7	11.2	6.5	1.6	1.6	61
34 22 130 ESD	061656	135	Half-round	polished	with multi-component grips	22.7	11.2	6.5	1.6	1.6	65
34 32 130	061496	135	Round, pointed	polished	with multi-component grips	23.7	11.2	6.5	2.0	1.0	59
34 32 130 ESD	061670	135	Round, pointed	polished	with multi-component grips	23.7	11.2	6.5	2.0	1.0	62
34 42 130	080282	130	Flat, wide with cross-hatching	polished	with multi-component grips	21.9	11.2	6.5	1.4	3.5	61
34 42 130 ESD	080299	130	Flat, wide with cross-hatching	polished	with multi-component grips	21.9	11.2	6.5	1.4	3.5	61
34 52 130	080312	130	Half-round with cross-hatching	polished	with multi-component grips	22.7	11.2	6.5	1.6	1.6	61
34 52 130 ESD	080305	130	Half-round with cross-hatching	polished	with multi-component grips	22.7	11.2	6.5	1.6	1.6	61

Electronics Pliers

- > Precision pliers for fine assembly work, e.g. in electronics and fine mechanics
- > Load-optimised for a more direct feel when working
- > For gripping, holding and bending
- > Sturdy, zero backlash box joint
- > Smooth ground gripping surfaces
- > Soft transitions; no sharp edges
- > Low-friction double spring for gentle and even opening
- > The mirror polish together with a fine film of oil offer effective rust protection – no circuit faults caused by peeling chrome from plated tools
- > Narrow sleeves pulled up to the head of the pliers enable the tool to be guided securely and comfortably, also between thumb and index finger
- > Edges carefully deburred
- > Ball bearing chrome steel, oil-hardened
- > DIN ISO 9655



35 11 115



35 12 115



35 21 115



35 22 115



35 31 115



35 32 115



35 41 115



35 42 115

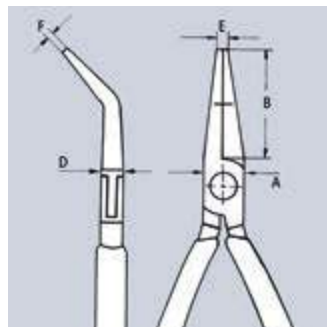
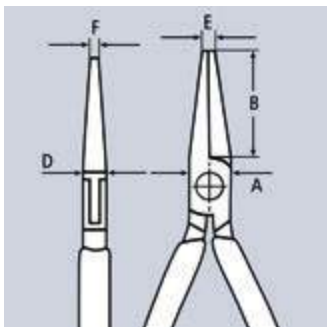

Article No.	EAN 4003773-	↔ mm		Head	Handles	Dimensions					⚖ g
						B mm	A mm	D mm	E mm	F mm	
35 11 115	016694	115		mirror polished	with non-slip plastic coating	22.5	11.0	6.5	2.0	4.0	55
35 12 115	035107	115		mirror polished	with multi-component grips	22.5	11.0	6.5	2.0	4.0	70
35 21 115	016724	115		mirror polished	with non-slip plastic coating	22.5	11.0	6.5	2.0	1.5	55
35 22 115	035114	115		mirror polished	with multi-component grips	22.5	11.0	6.5	2.0	1.5	70
35 31 115	016762	115		mirror polished	with non-slip plastic coating	22.5	11.0	6.5	2.0	1.0	61
35 32 115	035121	115		mirror polished	with multi-component grips	22.5	11.0	6.5	2.0	1.0	70
35 41 115	082248	115		mirror polished	with multi-component grips	22.5	11.0	6.5	2.0	1.0	55
35 42 115	040736	115		mirror polished	with multi-component grips	22.5	11.0	6.5	2.0	1.5	70
35 52 145	039389	145		mirror polished	with multi-component grips	40.0	12.0	7.5	1.5	4.0	102
35 62 145	039556	145		mirror polished	with multi-component grips	40.0	12.0	7.5	2.5	1.5	103
35 82 145	039396	145		mirror polished	with multi-component grips	35.0	12.0	7.5	2.5	1.0	102

Electronics Pliers ESD

- > Precision pliers for fine assembly work, e.g. in electronics and fine mechanics
- > For gripping, holding and bending
- > Electrically discharging handles - dissipative
- > Sturdy, zero backlash box joint
- > Smooth ground gripping surfaces
- > Edges carefully deburred
- > Low-friction double spring for gentle and even opening
- > The mirror polish together with a fine film of oil offer effective rust protection – no circuit faults caused by peeling chrome from plated tools
- > With two-colour dual component grips, black/grey
- > Ball bearing chrome steel, oil-hardened
- > DIN ISO 9655, DIN EN 61 340-5

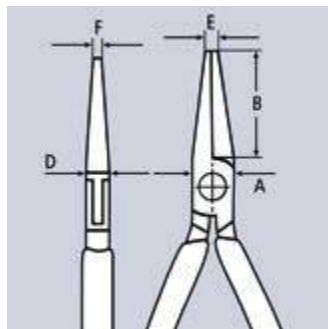
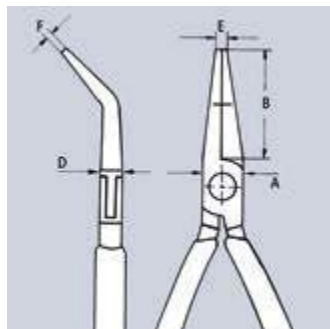

35 12 115 ESD



35 22 115 ESD



35 32 115 ESD



35 42 115 ESD

ESD pliers (electrostatic discharge)

Electrostatic energy is discharged through the handles in a gradual and controlled manner. Which protects components endangered by electrostatic discharge. In accordance with applicable standards, e.g. IEC TR 61 340-5, DIN EN 61 340-5, SP Method 2472



Article No.	EAN 4003773-	↔ mm	Head	Handles	Dimensions					⚖ g	
					B mm	A mm	D mm	E mm	F mm		
35 12 115 ESD	024835	115	3 MM	mirror polished	with multi-component grips	22.5	11.0	6.5	2.0	4.0	70
35 22 115 ESD	024842	115	3 MM	mirror polished	with multi-component grips	22.5	11.0	7.0	2.0	1.3	70
35 32 115 ESD	024859	115	8 MM	mirror polished	with multi-component grips	22.5	11.0	6.5	2.0	1.0	70
35 42 115 ESD	024866	115	45° MM	mirror polished	with multi-component grips	22.5	11.0	6.5	2.0	1.5	70

Electronics Mounting Pliers

- > Precision pliers for very fine assembly and repair work in electronics
- > For bending and cutting off wire ends on components
- > Sturdy, zero backlash box joint
- > Smooth ground gripping surfaces
- > Edges carefully deburred
- > Low-friction double spring for gentle and even opening
- > The mirror polish together with a fine film of oil offer effective rust protection – no circuit faults caused by peeling chrome from plated tools
- > Ball bearing chrome steel, oil-hardened



36 12 130



36 22 125



36 32 125

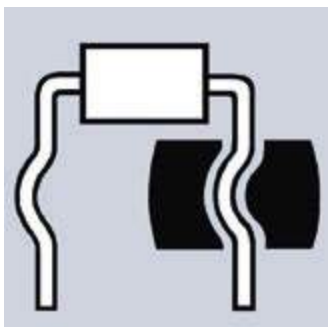
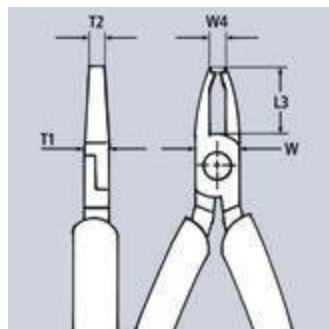
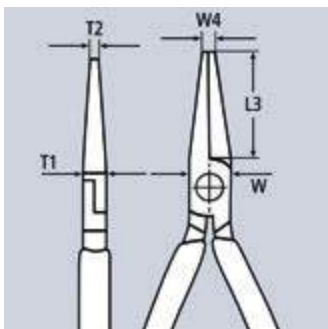

To bend wire in shape for the distance to the board

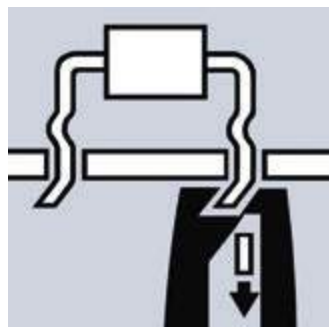

To bend and cut wire at 1.6 mm length below the board

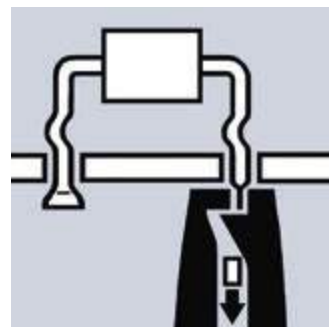

To crunch and cut wire at 1.6 mm length below the board

Article No.	EAN 4003773-	↔ mm		Head	Handles	Cutting capacities		Dimensions					△ g
						Ø mm	Ø mm	L3 mm	W mm	T1 mm	W1 mm	T2 mm	
36 12 130	016861	130	W	mirror polished	with multi-component grips			18.0	11.0	7.0	5.5	4.0	70
36 22 125	046967	125	W	mirror polished	with multi-component grips	1.2		18.0	11.0	7.0	7.5	4.0	94
36 32 125	016885	125	W	mirror polished	with multi-component grips	1.0		18.0	11.0	7.0	7.5	3.0	108

Electronics Pliers Sets

with tools for work on electronic components

> Dimensions, closed (W x H x D): 215 x 160 x 50 mm

00 20 16

> 7 parts, contains 6 electronics pliers and one pair of precision tweezers; case made of hard-wearing polyester fabric, pliers are held by elastic band, zippered



00 20 16



00 20 16 P

00 20 16 P

> 6 parts, contains 6 precision electronics pliers; case made of hard-wearing polyester fabric, pliers are held by elastic band, zippered

00 20 16 P ESD

> 6 parts, contains 6 ESD precision electronics pliers, electrically discharging version; case made of hard-wearing polyester fabric, pliers are held by elastic band, zippered

00 20 17

> 6 parts, contains 6 ESD precision electronics pliers, electrically discharging version; case made of hard-wearing polyester fabric, pliers are held by elastic band, zippered



00 20 16 P ESD



00 20 17

00 20 18

> 8 parts, contains 2 electronics pliers and 6 electronics screwdrivers; practical storage box, shock-resistant plastic, with foam insert

00 20 18 ESD

> 8 parts, contains 2 electronics pliers and 6 electronics screwdrivers, ESD electrically discharging version; practical storage box, shock-resistant plastic, with foam insert



00 20 18



00 20 18 ESD

Article No.	EAN 4003773-	Contents	g
00 20 16	022619	35 12 115 / 35 22 115 / 35 32 115 / 64 32 120 / 77 02 115 / 77 42 115 / 92 34 36	720
00 20 16 P	063223	34 12 130 / 34 22 130 / 34 32 130 / 79 02 120 / 79 02 120 / 79 02 125 / 79 42 125	575
00 20 16 P ESD	063230	34 12 130 ESD / 34 22 130 ESD / 34 32 130 ESD / 79 02 120 ESD / 79 02 125 ESD / 79 42 125 ESD	585
00 20 17	031222	35 12 115 ESD / 35 22 115 ESD / 35 42 115 ESD / 64 32 120 ESD / 77 02 115 ESD / 77 32 115 ESD	695
00 20 18	033073	35 22 115 / 77 02 115 / screw drivers 0,4 x 2,5 / 0,5 x 3,0 / 0,6 x 3,5 / 0,8 x 4,0 / PH0 / PH1	460
00 20 18 ESD	051848	35 22 115 ESD / 77 02 115 ESD / screw drivers 0,4 x 2,5 / 0,5 x 3,0 / 0,6 x 3,5 / 0,8 x 4,0 / PH0 / PH1	465

Tweezer Sets

- > Five high-quality sets of tweezers: Precision Tweezers, Universal Tweezers, SMD-, ESD, Plastic and Insulated Tweezers
- > Optimum combination: the tweezer sets come in various combinations in a high-quality tool roll for safe transport and damage-free storage
- > Two different tool rolls (VDE set with 5 compartments; others with 7 compartments)

92 00 01 ESD Universal Tweezers Set ESD

- > 5 pieces
- > DIN EN 61340 -5-1

92 00 02 Precision Tweezers Set

- > 5 pieces

92 00 03 SMD Precision Tweezers Set

- > 5 pieces

92 00 04 Universal Tweezers Set

- > 5 pieces
- > insulated

92 00 05 ESD Plastic Tweezers Set ESD

- > 5 pieces
- > DIN EN 61340 -5-1



92 00 01 ESD



92 00 02



92 00 03



92 00 04



92 00 05 ESD

Article No.	EAN 4003773-	Contents	△ g
92 00 01 ESD	087038	92 28 69 ESD / 92 28 70 ESD / 92 28 71 ESD / 92 38 75 ESD / 92 58 74 ESD	182
92 00 02	087021	92 21 01 / 92 21 02 / 92 21 03 / 92 31 01 / 92 51 01	180
92 00 03	087045	92 01 01 / 92 01 02 / 92 01 03 / 92 01 04 / 92 02 54	180
92 00 04	087052	92 27 61 / 92 27 62 / 92 37 64 / 92 47 01 / 92 67 63	275
92 00 05 ESD	087069	92 09 01 ESD / 92 09 02 ESD / 92 09 03 ESD / 92 09 04 ESD / 92 09 05 ESD	124
00 19 92 V01 LE	087229	Tool Roll for insulated tweezers, 5 compartments, empty	100
00 19 92 V02 LE	087236	Tool Roll for tweezers, 7 compartments, empty	100

Precision Tweezers

resistant to many chemicals

- > For particularly demanding precision work: tough and highly resistant to corrosion
- > Handcrafted: polished edges and an excellent matt, scratch-free and non-reflective surface
- > For the electronics industry, watchmakers, jewellers, laboratories with biological and medical applications in moderately aggressive chemical environments
- > High-quality premium stainless steel: high temperature resistance and excellent corrosion resistance to most chemicals, salts and acids
- > Ideally suited for microscopic work, precision handling, repairs, manufacturing electronic components, as well as other general applications; tips are guaranteed to have perfect symmetry and balance
- > Also available as a set (92 00 02)
- > Premium stainless steel

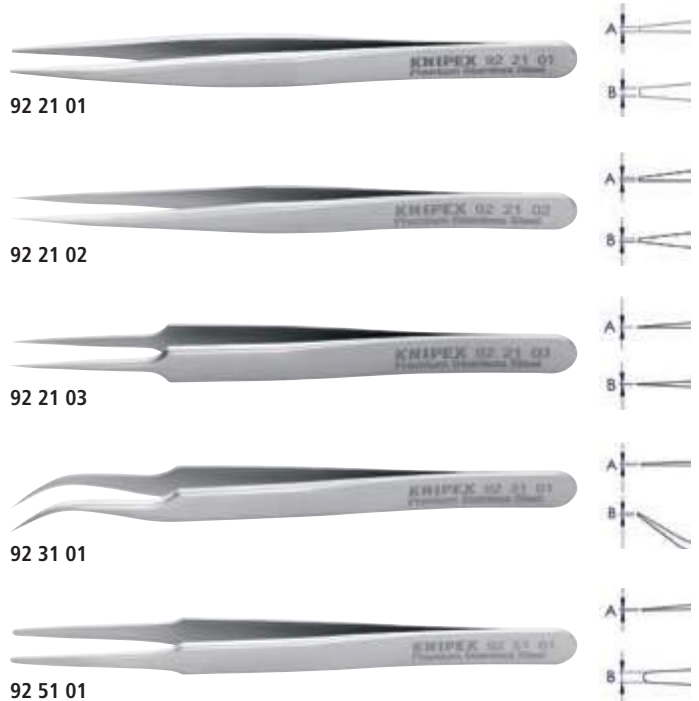

Article No.	EAN 4003773-	L x D x H mm	Gripping surface	Handles	Finish	Tweezers tip version	Tips width A x B mm	g
92 21 01	085041	120 x 10 x 13		smooth	straight	pointed	0.5 x 0.9	22
92 21 02	085065	110 x 9.5 x 11		smooth	straight	needle-point	0.12 x 0.18	12
92 21 03	085089	110 x 10 x 11		smooth	straight	needle-point	0.06 x 0.12	13
92 31 01	085027	120 x 10 x 11		smooth	bent 45°	needle-point	0.09 x 0.16	14
92 51 01	085126	120 x 10 x 11		smooth	straight	blunt	0.13 x 1.9	15

Mini Precision Tweezers

for precision work in confined spaces

- > For particularly demanding precision work: tough and highly resistant to corrosion
- > Handcrafted: polished edges and an excellent matt, scratch-free and non-reflective surface
- > For the electronics industry, watchmakers, jewellers, laboratories with biological and medical applications in moderately aggressive chemical environments
- > High-quality premium stainless steel: high temperature resistance and excellent corrosion resistance to most chemicals, salts and acids
- > Extra short and lightweight tweezers with narrow tips
- > Ideal for working in confined spaces, under the microscope and for precision close work
- > Ideal for sample handling, microscopy preparation, sorting, precision manufacturing, electronic assembly, rework and repair
- > Premium stainless steel

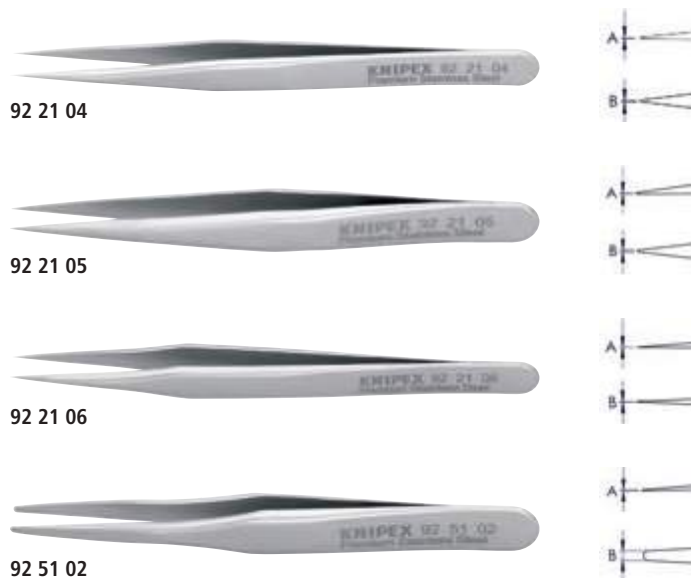

Article No.	EAN 4003773-	L x D x H mm	Gripping surface	Handles	Finish	Tweezers tip version	Tips width A x B mm	g
92 21 04	087526	90 x 8 x 10		smooth	straight	needle-point	0.09 x 0.15	9
92 21 05	086703	70 x 7 x 7.5		smooth	straight	needle-point	0.1 x 0.2	7
92 21 06	086710	80 x 6 x 7.5		smooth	straight	needle-point	0.08 x 0.13	7
92 51 02	086697	70 x 8 x 6.5		smooth	straight	blunt	0.1 x 1.2	6

Tweezers with exchangeable tips ESD

with versatile, exchangeable carbon fibre reinforced tips; electrically dissipative

- > For particularly demanding precision work: tough and highly resistant to corrosion
- > Maximum surface protection when handling sensitive electronic components, micro-mechanical parts, as well as glass and ceramic components
- > For the electronics and precision engineering industries, watchmakers and jewellers
- > Handcrafted body: polished edges and an excellent matt, scratch-free and non-reflective surface
- > High-quality premium stainless steel body: high temperature resistance and excellent corrosion resistance to most chemicals, salts and acids
- > The interchangeable tips are made from 30% carbon fibre reinforced plastic: very good electrical and thermal conductivity, scratch-proof and with high abrasion resistance
- > The interchangeable, carbon fibre reinforced plastic tips have a surface resistance between 10^2 and 10^4 ohms to compensate in a controlled manner the differences in potential between the operator and electronic components
- > The interchangeable tips are permanently temperature stable up to 130 °C, and up to 190 °C for short periods
- > The carbon fibre reinforced plastic tips are extremely flexible, fatigue-resistant, vibration-dampening and water-repellent
- > The tips have good chemical resistance to most oils, lubricants, fuels and nonpolar solvents
- > The same accuracy and stability as regular tweezers: the plastic tips have a 3-point connection with zero backlash (2 fixed points on the arms, one screw), which guarantee the user perfect attachment to the body with zero backlash
- > Premium stainless steel

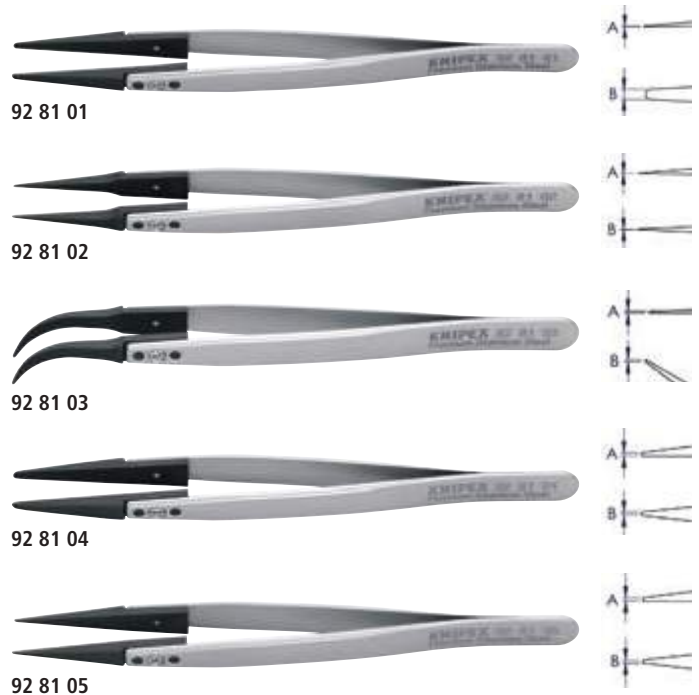

Interchangeable ESD tips

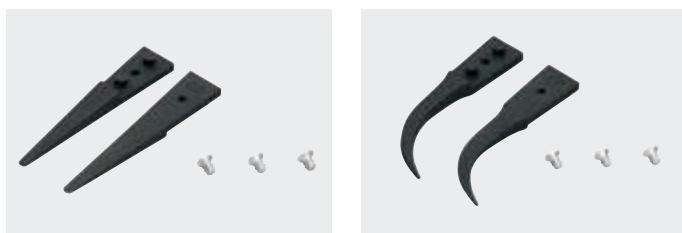

Article No.	EAN 4003773-	L x D x H mm	Gripping surface	Handles	Finish	Tweezers tip version	Tips width A x B mm	g	
92 81 01	087090	130 x 10 x 17		smooth	straight	blunt	0.4 x 2.0	17	
92 81 02	087113	130 x 10 x 17		smooth	straight	pointed	0.4 x 0.6	17	
92 81 03	087137	130 x 15 x 17		smooth	bent 60°	pointed	0.4 x 0.7	17	
92 81 04	087151	130 x 10 x 17		smooth	straight	blunt	1.0 x 2.0	17	
92 81 05	087175	130 x 10 x 17		smooth	straight	pointed	0.7 x 0.6	17	
92 89 01	087106	40 x 8 x 3.5	Exchangeable ESD tips, for 92 81 01						1
92 89 02	087120	40 x 8 x 3.5	Exchangeable ESD tips, for 92 81 02						1
92 89 03	087144	40 x 15 x 3.5	Exchangeable ESD tips, for 92 81 03						1
92 89 04	087168	40 x 8 x 4	Exchangeable ESD tips, for 92 81 04						1
92 89 05	087182	40 x 8 x 3.5	Exchangeable ESD tips, for 92 81 05						1

Cutting Tweezers

hard and sharp for finest cutting work

- > For particularly demanding precision work: made from high-quality, martensitic hardened steel, tough and highly resistant to corrosion
- > Stainless steel with a slim, tapered design for maximum precision when cutting, dissecting and segmenting extremely small objects in tight spaces
- > For the electronics industry, as well as repairs and handicrafts
- > Mainly used for cutting soft copper, gold or silver wires, as well as magnetic wires
- > With extremely hard and sharp oblique cutting nippers
- > Also available as an ESD-version: with black epoxy resin coating and a surface resistance between 10^3 and 10^9 ohms
- > ESD version only: this allows to compensate in a controlled manner the differences in potential between the operator and electronic components

92 11 01

- > Stainless steel

92 11 01 ESD

- > Stainless steel, DIN EN 61340 -5-1



92 11 01



92 11 01 ESD

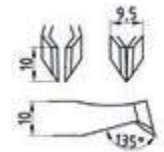

Article No.	EAN	L x D x H mm	Gripping surface	Handles	Finish	Tweezers tip version	Tips width A x B mm	g
92 11 01	085003	115 x 11 x 15		smooth	bent	cutting	4.75 x 10.0	26
92 11 01 ESD	086727	115 x 11 x 17	⚠	smooth	bent	cutting	4.75 x 10.0	27

Universal Tweezers

Ideal for demanding standard applications

- > Universal Tweezers are suitable for demanding standard applications and precision tasks
- > Wide range of designs: straight, angled, gripping surfaces and handles smooth or serrated, with needle points, narrow or blunt tips, as well as different lengths
- > For the electronics industry, watchmakers and jewellers
- > High quality stainless steel: extremely tough and very good corrosion resistance against a variety of atmospheric environments and many corrosive materials
- > Stainless steel

92 01 05, 92 01 06

- > Premium stainless steel

92 34 37

- > Steel, black lacquered

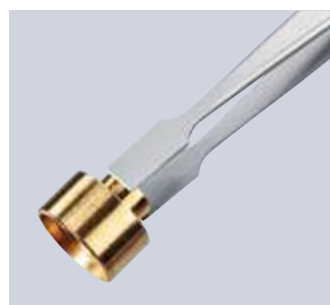

92 01 05



92 01 06



92 21 07



92 21 08



92 22 04



92 22 06



92 22 07

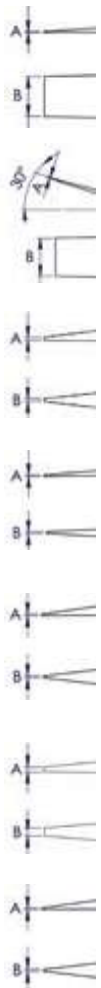

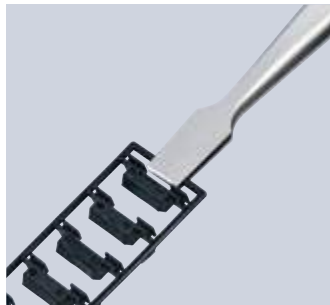

Article No.	EAN 4003773-	L x D x H mm	Gripping surface	Handles	Finish	Tweezers tip version	Tips width A x B mm	△ g
92 01 05	086758	120 x 10 x 12		knurled	straight	blunt	0.17 x 6.0	16
92 01 06	086765	120 x 10 x 18		knurled	bent 30°	blunt	0.17 x 6.0	16
92 21 07	086734	110 x 10 x 10		smooth	straight	needle-point	0.2 x 0.25	14
92 21 08	086741	140 x 8 x 12		smooth	straight	needle-point	0.2 x 0.3	15
92 22 04	054665	128 x 12 x 10		smooth	straight	pointed	0.3 x 0.5	18
92 22 06	054672	120 x 10 x 11		smooth	straight	needle-point	0.25 x 0.25	20
92 22 07	054689	125 x 11 x 10		smooth	straight	needle-point	0.2 x 0.25	17
92 22 12	054696	110 x 10 x 11		smooth	straight	needle-point	0.2 x 0.2	15
92 22 13	054702	130 x 11 x 14		smooth	straight	pointed	0.4 x 0.5	21
92 22 35	054719	155 x 8 x 18		knurled	straight	pointed	0.5 x 0.5	21
92 32 29	054818	118 x 10 x 10		smooth	bent 35°	needle-point	0.25 x 0.3	15
92 34 36	054832	152 x 8 x 18		knurled	bent 25°	pointed	0.5 x 0.5	21
92 34 37	054849	155 x 8 x 14		knurled	bent 25°	pointed	0.8 x 0.8	21
92 52 23	054894	118 x 10 x 10		smooth	straight	blunt	0.3 x 2.0	16
92 61 01	085119	200 x 12 x 20		knurled	straight	blunt	2.0 x 3.2	52
92 61 02	085133	300 x 15 x 22		knurled	straight	blunt	2.5 x 4.7	105
92 64 43	054917	120 x 10 x 14		knurled	straight	blunt	1.2 x 2.7	17
92 72 45	054962	145 x 11 x 15		knurled	straight	blunt	1.3 x 2.7	24
92 84 18	054986	126 x 11 x 18		smooth	straight	blunt	0.5 x 1.0	17

Universal Tweezers ESD

DIN EN 61340 -5-1, electrically dissipative, for electronics and fine mechanics

- > Electrically dissipative coating: Universal tweezers in the ESD version equalize differences in electrical potential between their user and the workpieces in a controlled manner
- > ESD-tested, black epoxy resin coating with a surface resistance between 10^3 and 10^9 ohms
- > For the electronics and precision engineering industries
- > Antimagnetic to avoid electromagnetic damage
- > Wide range of designs: straight, angled, gripping surfaces and handles smooth or serrated, with needle points, narrow or blunt tips
- > The high quality stainless steel ensures extreme toughness and very good corrosion resistance against a variety of atmospheric environments and many corrosive materials
- > Also available as a set (92 00 01 ESD)
- > Stainless steel

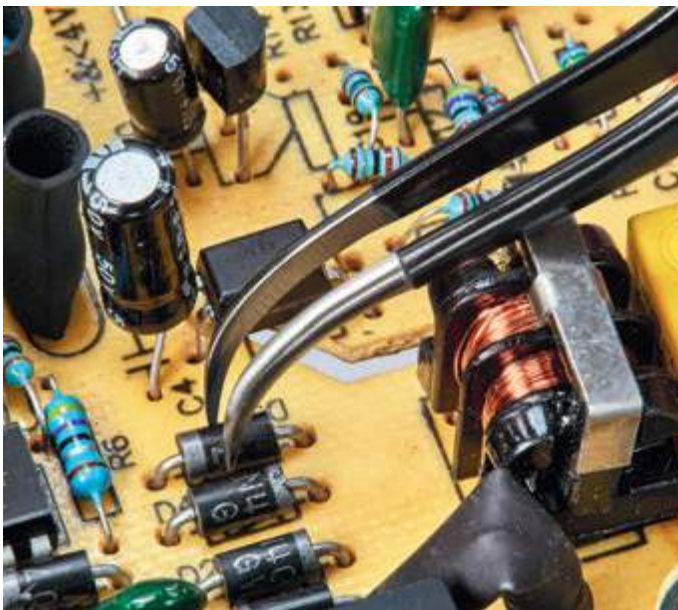

Article No.	EAN 4003773-	L x D x H mm	Gripping surface	Handles	Finish	Tweezers tip version	Tips width A x B mm	△ g
92 21 01 ESD	086772	125 x 11 x 12		smooth	straight	needle-point	0.2 x 0.25	17
92 21 02 ESD	086789	128 x 12 x 12		smooth	straight	pointed	0.3 x 0.5	18
92 21 03 ESD	086796	140 x 8 x 14		smooth	straight	needle-point	0.2 x 0.3	15
92 28 69 ESD	054771	120 x 10 x 13		smooth	straight	needle-point	0.25 x 0.25	20
92 28 70 ESD	054788	110 x 10 x 12		smooth	straight	needle-point	0.2 x 0.25	14
92 28 71 ESD	054795	110 x 10 x 12		smooth	straight	needle-point	0.2 x 0.2	15
92 28 72 ESD	054801	130 x 11 x 14		smooth	straight	pointed	0.4 x 0.5	21
92 38 75 ESD	054863	118 x 10 x 12		smooth	bent 35°	needle-point	0.25 x 0.3	15
92 58 74 ESD	054900	118 x 10 x 12		smooth	straight	blunt	0.3 x 2.0	16
92 78 77 ESD	054979	145 x 11 x 17		knurled	straight	blunt	1.3 x 2.7	24

SMD Precision Tweezers

optimised for electronics work with SMD components

- > When working on SMD components (SMD = surface mounted device): the fine geometry of the SMD tweezers also allows work to be carried out on electronic components that can be soldered directly onto the circuit board using solderable connecting surfaces
- > Handcrafted: polished edges and an excellent matt, scratch-free and non-reflective surface
- > For assembly work, laboratory processes, clean room environments, circuit board repairs and reworking in the electronics industry
- > High-quality premium stainless steel: high temperature resistance and excellent corrosion resistance to most chemicals, salts and acids
- > Antimagnetic to avoid electromagnetic damage
- > The variety of designs and jaw types enables small components to be held, positioned and controlled securely in confined spaces
- > Also available as a set (92 00 03)
- > Premium stainless steel

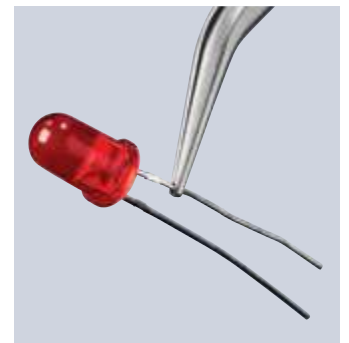

Article No.	EAN 4003773-	L x D x H mm	Gripping surface	Handles	Finish	Tweezers tip version	Tips width A x B mm	g
92 01 01	085522	115 x 10 x 11		smooth	bent 45°	positioning	0.33 x 1.6	15
92 01 02	085539	120 x 10 x 11		smooth	double bent 35°	positioning	0.15 x 1.5	15
92 01 03	085546	120 x 10 x 11		smooth	straight	positioning	0.3 x 1.5	15
92 01 04	085591	115 x 10 x 11		smooth	bent 45°	positioning	0.5 x 1.5	15
92 02 54	054610	115 x 10 x 11		smooth	bent 30°	positioning	0.6 x 0.9	14

SMD Precision Tweezers ESD

- > Allow to compensate in a controlled manner the differences in potential between the operator and electronic components
- > With a tested black epoxy resin coating with a surface resistance between 10³ and 10⁹ ohms
- > Stainless steel



Article No.	EAN 4003773-	L x D x H mm	Gripping surface	Handles	Finish	Tweezers tip version	Tips width A x B mm	g
92 08 78 ESD	085515	118 x 10 x 12		smooth	bent 45°	positioning	0.5 x 2.5	18

Positioning Tweezers

for exact positioning or pulling of small components

- > Makes it easy to hold, insert and pull even the smallest elongated components
- > With gripping surfaces in dimensionally adapted designs, for example for firmly and securely positioning or pulling sensitive rounded or cuboid components
- > For through-hole technology (THT) and pin-in-hole technology (PIH)
- > Antimagnetic to avoid electromagnetic damage
- > Stainless steel



Article No.	EAN 4003773-	L x D x H mm	Gripping surface	Handles	Finish	Tweezers tip version	Tips width A x B mm	⚖️ g
92 01 07	086932	143 x 11 x 17		knurled	bent 90°	positioning	3.5 x 5.8	25
92 11 02	085034	145 x 11 x 16.5		knurled	straight	positioning	2.8 x 5.5	23
92 11 03	085553	122 x 10 x 14.5		knurled	straight	positioning	2.5 x 4.0	15

Positioning Tweezers ESD

- > Allow to compensate in a controlled manner the differences in potential between the operator and electronic components
- > With a tested black epoxy resin coating with a surface resistance between 10³ and 10⁹ ohms
- > Stainless steel



Article No.	EAN 4003773-	L x D x H mm	Gripping surface	Handles	Finish	Tweezers tip version	Tips width A x B mm	⚖️ g
92 08 79 ESD	085584	122 x 10 x 14.5		knurled	straight	positioning	2.5 x 4.0	15
92 16 01 ESD	086949	120 x 10 x 14		smooth	bent 35°	positioning	1.5 x 3.8	15
92 16 02 ESD	086956	120 x 10 x 14.5		smooth	bent 35°	positioning	2.5 x 4.0	15

Titanium Tweezers

extremely light, heat-, corrosion- and acid-resistant

- > Particularly suitable for precision tasks that require corrosion resistance, high strength and low weight
- > The high-quality titanium alloy offers high temperature resistance and very good resistance to corrosion in air, sea and a variety of industrial environments at room temperature
- > For cleaning or chemical processes, use at high temperatures and in biology, medicine or surgery
- > 100 percent anti-magnetic
- > Antibacterial
- > Titanium



Article No.	EAN 4003773-	L x D x H mm	Gripping surface	Handles	Finish	Tweezers tip version	Tips width A x B mm	g
92 23 01	085010	110 x 10 x 11		smooth	straight	needle-point	0.09 x 0.15	7
92 23 05	054726	120 x 10 x 11		smooth	straight	pointed	0.3 x 0.5	8

Precision Cross Jaw Tweezers

hold automatically due to their spring force, for filigree work

- > Hold automatically: Their spring force makes these holding tweezers perfect for soldering small and very small components, among other uses
- > For applications that require a high-precision self-closing function, for example in microscopy or for precision assembly or soldering tasks
- > For soldering work on transistors, gold wire diodes, etc.
- > Suitable for a wide variety of applications in the electronics industry thanks to perfectly symmetrical tips and excellent balance
- > Handcrafted, with an excellent matt, scratch-free and non-reflective surface
- > Precision cross jaw tweezers for particularly challenging applications when corrosion resistance and toughness are the main requirements
- > The high-quality premium stainless steel versions offer high temperature resistance and excellent corrosion resistance to most chemicals, salts and acids
- > Premium stainless steel



Article No.	EAN 4003773-	L x D x H mm	Gripping surface	Handles	Finish	Tweezers tip version	Tips width A x B mm	g
92 91 01	086802	120 x 10 x 11		smooth	straight	blunt	0.13 x 1.9	13
92 91 02	086819	120 x 10 x 11		smooth	straight	needle-point	0.12 x 0.2	12
92 91 03	086826	115 x 10 x 11		smooth	bent 45°	needle-point	0.22 x 0.25	12

Universal cross jaw tweezers

hold automatically due to their spring force, ideal helpers for soldering

- > Hold automatically: Their spring force makes these holding tweezers perfect for soldering small and very small components, among other uses
- > For applications that require a high-precision self-closing function, for example in microscopy or for precision assembly or soldering tasks
- > For soldering work on transistors, gold wire diodes, etc.
- > Suitable for a wide variety of applications in the electronics industry thanks to perfectly symmetrical tips and excellent balance
- > The high quality stainless steel ensures extreme toughness and very good corrosion resistance against a variety of atmospheric environments and many corrosive materials
- > Stainless steel



Article No.	EAN 4003773-	L x D x H mm	Gripping surface	Handles	Finish	Tweezers tip version	Tips width A x B mm	Δg
92 94 91	055006	160 x 11.5 x 13		knurled	straight	blunt	1.3 x 4.5	30
92 95 89	055013	165 x 11 x 20		smooth	straight	blunt	0.8 x 1.0	28
92 95 90	055020	162 x 11 x 20		knurled	bent 40°	blunt	0.8 x 1.0	28

Plastic Tweezers ESD

extremely light and robust, electrically dissipative

- > ESD tweezers are made of 30% carbon fibre reinforced plastic, are electrically and thermally highly conductive and are characterised by high resistance to abrasion and scratching
- > With a surface resistance between 10² and 10⁴ ohms to compensate in a controlled manner the differences in potential between the operator and the electronic components
- > Temperature stable up to 130°C, brief exposures of up to 190°C are possible
- > The carbon fibre-reinforced plastic is extremely flexible, fatigue-resistant, vibration-reducing and water-repellent, with good chemical resistance to most oils, greases, fuels and nonpolar solvents
- > Ideal for maximum surface protection when handling sensitive electronic components, micro-mechanical parts, as well as glass and ceramic components
- > Also available as a set (92 00 05 ESD)
- > Carbon fibre-reinforced plastic

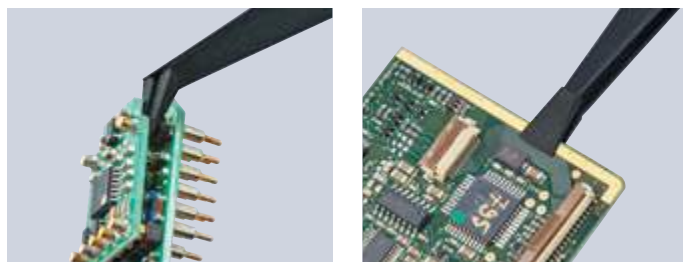
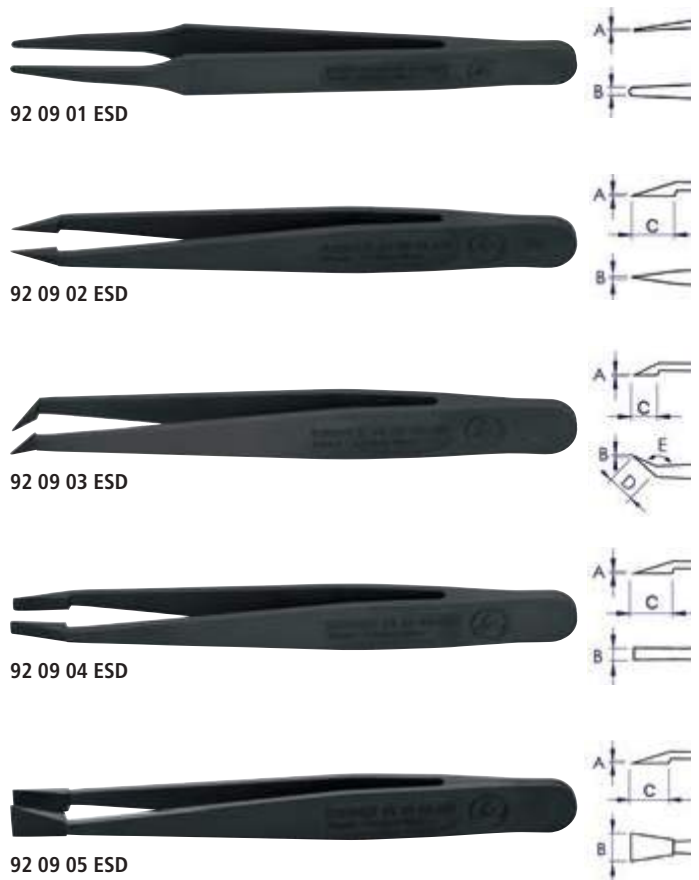

Article No.	EAN 4003773-	L x D x H mm	Gripping surface	Handles	Finish	Tweezers tip version	Tips width A x B x C x D mm	Δg
92 09 01 ESD	086970	115 x 9.5 x 13		smooth	straight	blunt	0.35 x 2.0	4
92 09 02 ESD	086987	115 x 11.5 x 15		smooth	straight	needle-point	0.5 x 0.3 x 9.5	4,5
92 09 03 ESD	086994	110 x 11.5 x 15		smooth	bent 45°	pointed	0.5 x 0.4 x 5.8 x 8.5	4,5
92 09 04 ESD	087007	115 x 11.5 x 15		smooth	straight	blunt	0.12 x 3.3 x 11.5	4,5
92 09 05 ESD	087014	115 x 11.5 x 15		smooth	straight	blunt	0.12 x 7.7 x 11.3	4,5

Plastic Tweezers

extremely light and robust

- > Plastic disposable tweezers for the chemicals, pharmaceuticals or cosmetics sector, food industry and scientific use; ideal for gripping, holding and moving small objects, such as fine tissues, small items or solid samples
- > Made of 30% glass fiber reinforced plastic for high strength and flexibility
- > Plastic disposable tweezers are characterised by their high temperature resistance and excellent chemical resistance
- > The grooved handles ensure optimum safe handling and precision; with internally serrated tips and a particularly wide clamping area
- > Plastic



92 69 84



Article No.	EAN 4003773-	L x D x H mm	Gripping surface	Handles	Finish	Tweezers tip version	Tips width A x B mm	ΔΔ g
92 69 84	054948	129 x 13 x 33		knurled	straight	blunt	2.0 x 3.0	19

Universal Tweezers, insulated

DIN EN 60900, IEC 60900, tested protection against electrical voltage up to 1000 V

- > With insulated handles for working on electrical installations: safety up to 1000 V
- > For a wide range of requirements and applications in the electronics industry
- > Individually tested in accordance with 1000 V EN 60900 / IEC 60900 / VDE and approved for work with voltage up to 1000 volts
- > The insulation is REACH-compliant and free from phthalates that are harmful to health
- > High quality stainless steel: extremely tough and very good corrosion resistance against a variety of atmospheric environments and many corrosive materials
- > Also available as a set (92 00 04)
- > Stainless steel



92 27 61



92 27 62



92 37 64



92 47 01



92 67 63

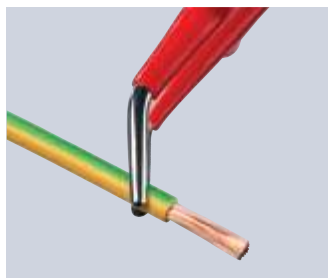

Article No.	EAN 4003773-	L x D x H mm	Gripping surface	Handles	Finish	Tweezers tip version	Tips width A x B mm	ΔΔ g
92 27 61	054757	125 x 11 x 35	⚡ 1000 V	smooth	straight	pointed	0.5 x 0.5	21
92 27 62	054764	150 x 8 x 40	⚡ 1000 V	smooth	straight	pointed	1.0 x 1.3	22
92 37 64	054856	148 x 14 x 40	⚡ 1000 V	smooth	bent 30°	blunt	1.0 x 1.3	22
92 47 01	086963	142 x 16 x 38	⚡ 1000 V	smooth	bent 30°	blunt	1.3 x 3.0	29
92 67 63	054931	145 x 11 x 38	⚡ 1000 V	smooth	straight	blunt	1.3 x 3.0	29

Pliers with tether attachment point for mounting a fall protection



Pliers range with tether attachment point
for mounting a fall protection

274-277







The tether attachment point for the range with multi-component handles







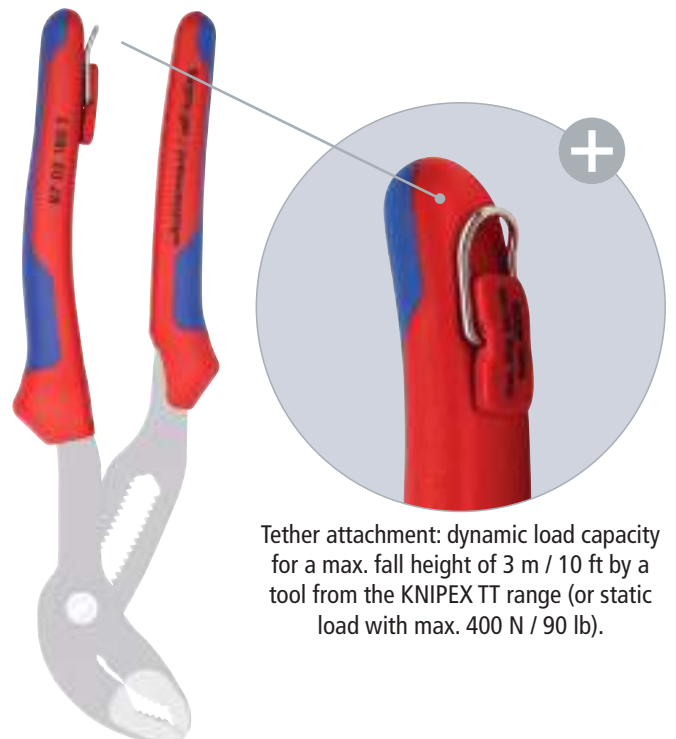



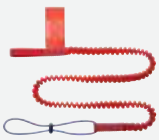

Tools can fall down when used on cherry pickers, scaffolding and ladders and when used by industrial climbers working with wire rope hoists.

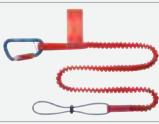

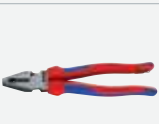



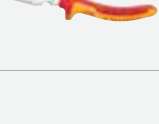
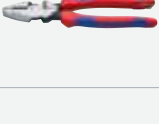

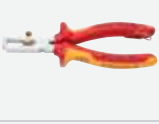



KNIPEX offers a range of pliers and accessories that can reliably prevent the KNIPEX pliers from falling down.

There is a very stable tether on the inside of the handles which is welded tightly to the handle for attaching the tether or adapter strap. The lug enables the equipment to be attached and put down quickly. The sophisticated elements from our KNIPEX Tethered Tools Program offer several individual permutations for connection and use.



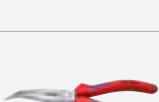

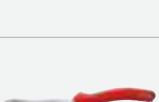
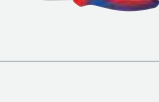



PLIERS WITH TETHER ATTACHMENT POINT

	Article No.	Designation	page
	00 50 01 T BK	Tether	
	00 50 02 T BK	Adapter Strap	
	00 50 03 T BK	Carabiner	
	00 50 04 T BK	Tethering System Set	
	00 50 05 T BK		
	00 50 06 T BK		
	02 02 225 T	High Leverage Combination Pliers, with multi-component grips, with integrated tether attachment point for a tool tether, DIN ISO 5746	5
	03 06 180 T	Combination Pliers, insulated, with multi-component grips, VDE-tested, with integrated tether attachment point for a tool tether, DIN ISO 5746	5, 199
	08 22 145 T	Needle-Nose Combination Pliers, with multi-component grips, with integrated tether attachment point for a tool tether, DIN ISO 5746	6
	08 26 145 T	Needle-Nose Combination Pliers, insulated, with multi-component grips, VDE-tested, with integrated tether attachment point for a tool tether, DIN ISO 5746	6, 200
	09 02 240 T	Lineman's Pliers, American style, with multi-component grips, with integrated tether attachment point for a tool tether, DIN ISO 5746	9
	09 12 240 T	Lineman's Pliers, American style, with slim multi-component grips, with integrated tether attachment point for a tool tether, DIN ISO 5746	9
	11 06 160 T	Insulation Stripper with opening spring, insulated, with multi-component grips, VDE-tested, with integrated tether attachment point for a tool tether	20, 200
	13 05 160 T	Electricians' Pliers, with multi-component grips, with integrated tether attachment point for a tool tether	12

	Article No.	Designation	page
	13 66 180 T (PATENTED)	KNIPEX StriX® Insulation strippers, with cable shears, insulated, with multi-component grips, VDE-tested, with integrated tether attachment point for a tool tether	35, 201
	13 82 200 T (PATENTED)	Pliers for Electrical Installation, with multi-component grips, with integrated tether attachment point for a tool tether	10
	13 96 200 T (PATENTED)	Pliers for Electrical Installation, insulated, with multi-component grips, VDE-tested, with integrated tether attachment point for a tool tether	10, 204
	25 06 160 T	Snipe Nose Side Cutting Pliers (Radio Pliers), insulated, VDE-tested, with integrated tether attachment point for a tool tether, DIN ISO 5745	15, 205
	26 12 200 T	Snipe Nose Side Cutting Pliers (Stork Beak Pliers), with multi-component grips, with integrated tether attachment point for a tool tether, DIN ISO 5745	16
	26 15 200 T	Snipe Nose Side Cutting Pliers (Stork Beak Pliers), with multi-component grips, with integrated tether attachment point for a tool tether, DIN ISO 5745	16
	26 16 200 T	Snipe Nose Side Cutting Pliers (Stork Beak Pliers), insulated, with multi-component grips, VDE-tested, with integrated tether attachment point for a tool tether, DIN ISO 5745	16, 206
	26 22 200 T	Snipe Nose Side Cutting Pliers (Stork Beak Pliers), with multi-component grips, with integrated tether attachment point for a tool tether, DIN ISO 5745	16
	26 25 200 T	Snipe Nose Side Cutting Pliers (Stork Beak Pliers), with multi-component grips, with integrated tether attachment point for a tool tether, DIN ISO 5745	16
	26 26 200 T	Snipe Nose Side Cutting Pliers (Stork Beak Pliers), with multi-component grips, with integrated tether attachment point for a tool tether, DIN ISO 5745	16, 206
	38 35 200 T	Mechanics' Pliers, with multi-component grips, with integrated tether attachment point for a tool tether, DIN ISO 5745	53
	70 05 180 T	Diagonal Cutter, with multi-component grips, with integrated tether attachment point for a tool tether, DIN ISO 5749	85
	70 05 160 T	Diagonal Cutter, with multi-component grips, with integrated tether attachment point for a tool tether, DIN ISO 5749	85
	70 06 180 T	Diagonal Cutter, insulated, with multi-component grips, VDE-tested, with integrated tether attachment point for a tool tether, DIN ISO 5749	85, 208
	70 06 160 T	Diagonal Cutter, insulated, with multi-component grips, VDE-tested, with integrated tether attachment point for a tool tether, DIN ISO 5749	85, 208

	Article No.	Designation	page
	71 02 200 T	KNIPEX CoBolt Compact Bolt Cutters, with slim multi-component grips, with integrated tether attachment point for a tool tether	94
	71 22 200 T		95
	71 32 200 T		95
	73 05 160 T (PATENTED)	KNIPEX X-Cut® Compact Diagonal Cutter, with multi-component grips, with integrated tether attachment point for a tool tether, DIN ISO 5749	87
	73 06 160 T (PATENTED)	KNIPEX X-Cut® Compact Diagonal Cutter, insulated, with multi-component grips, VDE-tested, with integrated tether attachment point for a tool tether, DIN ISO 5749	87, 209
	74 02 200 T	High Leverage Diagonal Cutter, with multi-component grips, with integrated tether attachment point for a tool tether, DIN ISO 5749	88
	74 02 250 T		88
	74 06 200 T	High Leverage Diagonal Cutter, insulated, with multi-component grips, VDE-tested, with integrated tether attachment point for a tool tether, DIN ISO 5749	88, 209
	74 06 250 T		88, 209
	74 22 200 T	High Leverage Diagonal Cutter, with multi-component grips, with integrated tether attachment point for a tool tether, DIN ISO 5749	88
	74 22 250 T		88
	86 05 180 T	Pliers Wrench, Pliers and a wrench in a single tool, with multi-component grips, with integrated tether attachment point for a tool tether	104
	86 05 250 T		104
	87 02 180 T	KNIPEX Cobra® Hightech Water Pump Pliers, with multi-component grips, with integrated tether attachment point for a tool tether, DIN ISO 8976	110
	87 02 300 T	KNIPEX Cobra® Hightech Water Pump Pliers, with multi-component grips, with integrated tether attachment point for a tool tether, DIN ISO 8976	110
	87 02 250 T		110
	87 26 250 T	KNIPEX Cobra® VDE Hightech Water Pump Pliers, insulated, VDE-tested, with integrated tether attachment point for a tool tether, DIN ISO 8976	115, 211

	Article No.	Designation	page
	88 02 250 T	KNIPEX Alligator® Water Pump Pliers, with slim multi-component grips, with integrated tether attachment point for a tool tether, DIN ISO 8976	116
	88 02 300 T	KNIPEX Alligator® Water Pump Pliers, with multi-component grips, with integrated tether attachment point for a tool tether, DIN ISO 8976	116
	95 12 165 T	Cable Shears, with multi-component grips, with integrated tether attachment point for a tool tether	150
	95 16 165 T	Cable Shears, insulated, with multi-component grips, VDE-tested, with integrated tether attachment point for a tool tether	150, 213
	95 62 190 T	Wire Rope Cutter, forged, with multi-component grips, with integrated tether attachment point for a tool tether	160
	97 78 180 T	Crimping Pliers for wire ferrules, insulated, with multi-component grips, VDE-tested, with integrated tether attachment point for a tool tether	184, 260

Tool Assortment and Tool Cases



Tool Roll	280, 336
Pliers Wrench Set	281
KNIPEX Cobra® Set	281
Set of Circlip Pliers	282 – 283
Mini Pliers Sets	284 – 285
Case for Electronics Pliers	286
Pliers Sets in a foam tray	287
Precision Circlip Pliers Set	288
Set of Circlip Pliers	288
Tool Sets in a blister	289
Extension sets Electric	289
Tool Kits	290 – 292
Pliers Sets	293
Tool Box "RED" Electric Set 1	294
Tool Box "RED" Electric Set 2	294
Tool Box "SRZ" Precision Circlip Pliers	295
Tool Case "Basic"	297
Tool Case "BIG Basic Move"	299
Tool Case "BIG Basic Move" Electric	300
Tool Case „BIG Basic Move“ ElectricPlus	301
Tool Case "BIG Basic Move" Mechanics	302
Tool Case "BIG Basic Move" Plumbing	303
Tool Case "Big Twin Move"	306
Tool Case "Big Twin Move" Electric	307
Tool Case "Big Twin"	308
Tool Case "Big Twin" Electric	309
Tool Case "Big Twin Move Red" Electric Competence	310
Tool Case "Robust"	313
Tool Case "Robust23" Electric	314
Tool Case "Robust34" Electric	316
Tool Case "Robust45 Move" Electric	318
Tool Case "Robust45 Move" Mechanics	320
Tool Case "Vision24" Electric	322
Tool Case "Vision27" Plumbing	323
KNIPEX L-BOXX®	324
KNIPEX L-BOXX® Electric	325
KNIPEX L-BOXX® Plumbing	326
Tool bag "Classic" Electric	327
Tool bag "Compact" Electric	328
Crimp Assortments	329 – 330
Tool Case for Photovoltaics	331
Compact Tool Case	332 – 333
Tool bags	334 – 335
Belt Pouch	337















Tool Roll

Essential for work on electrical systems: 15-piece basic tool kit in practical roll-up bag

- > Tool roll made of hard-wearing polyester fabric
- > With practical, adjustable quick release fastener
- > Equipped with a range of insulated KNIPEX tools for works on electrical installations
- > Dimensions, open (L x H): 830 x 310 mm



98 99 13

Article No.	EAN				Number	g
98 99 13	4003773-026648		Tool Roll, 15 parts			2455
		 	03 07 200	Combination Pliers	1	
		 	11 07 160	Insulation Stripper	1	
			26 17 200	Snipe Nose Side Cutting Pliers (Stork Beak Pliers)	1	
			70 07 160	Diagonal Cutter	1	
			95 17 200	Cable Shears with twin cutting edge	1	
			98 00 10		1	
			98 00 13		1	
		 	98 00 14	Open-end wrench	1	
			98 00 17		1	
			98 00 19		1	
			98 20 25		1	
		 	98 20 40	Screwdrivers for slotted screws	1	
			98 20 55		1	
			98 20 65		1	
		 	98 52	Cable Knife	1	
98 99 13 LE	028888	Tool Roll, empty				325











Tool Roll

Handy, ideally equipped: eleven-piece set of tools for telecommunications and electrical engineers

- > For telecommunications and electrical engineers
- > Tool roll made of hard-wearing polyester fabric
- > With practical, adjustable quick release fastener
- > Contains eight pliers and three screwdrivers
- > Pliers with chrome-plated heads and two-colour dual component handles
- > Screwdrivers VDE tested according to DIN EN/IEC 60900 1000V
- > Dimensions, open (L x H): 450 x 290 mm



00 19 41

Article No.	EAN				Number	g
00 19 41	4003773-024729		Tool Roll, 11 parts			1620
			03 05 160	Combination Pliers	1	
			11 05 160	Insulation Stripper	1	
			25 05 160	Snipe Nose Side Cutting Pliers (Radio Pliers)	1	
			30 15 160	Long Nose Pliers	1	
			30 35 160		1	
			31 15 160	Flat Nose Pliers (Needle-Nose Pliers)	1	
			67 05 140	High Leverage End Cutting Nipper	1	
			70 05 140	Diagonal Cutter	1	
		 	98 20 25	Screwdrivers for slotted screws	1	
			98 20 40		1	
		 	98 24 01	Screwdriver for cross recessed screws, Phillips®	1	
00 19 41 LE	035930	Tool Roll, empty				205

Pliers Wrench Set

All-purpose tool in a set: five pliers wrenches in space-saving roll-up bag

- > Tool roll made of hard-wearing polyester fabric
- > With hook-and-loop fastener
- > Equipped with pliers wrenches in five different lengths from 125 to 300 mm
- > Dimensions, open (L x H): 430 x 325 mm



00 19 55 S4



00 19 55 S6



00 19 55 S7

Article No.	EAN			g
00 19 55 S4	4003773-077817	▱	Pliers Wrench Set, 5 parts (1x 86 03 125, 1x 86 03 150, 1x 86 03 180, 1x 86 03 250, 1x 86 03 300)	1925
00 19 55 S6	086505	▱	Pliers Wrench Set, 3 parts (1x 86 03 125, 1x 86 03 180, 1x 86 03 250)	1030
00 19 55 S7	086512	▱	Pliers Wrench Set, 3 parts (1x 86 03 150, 1x 86 03 250, 1x 86 03 300)	1520
00 19 55 S4 LE	077824		Roll-up case for pliers wrenches, empty, 6 compartments	260
00 19 55 S6 LE	086482		Roll-up case for pliers wrenches, empty, 4 compartments	220

KNIPEX Cobra® Set

Gripping set for professionals: five KNIPEX Cobra® pliers in hard-wearing roll-up bag

- > High-quality roll-up bag made from durable polyester fabric
- > With hook-and-loop fastener
- > Equipped with KNIPEX Cobra® high-tech water pump pliers in five different lengths from 125 to 300 mm
- > Dimensions, open (L x H): 430 x 325 mm



00 19 55 S5



00 19 55 S8



00 19 55 S9

Article No.	EAN			g
00 19 55 S5	4003773-082613	▱	KNIPEX Cobra® Set, 5 parts (1x 87 01 125, 1x 87 01 150, 1x 87 01 180, 1x 87 01 250, 1x 87 01 300)	1567
00 19 55 S8	086529	▱	KNIPEX Cobra® Set, 3 parts (1x 87 01 125, 1x 87 01 180, 1x 87 01 250)	1255
00 19 55 S9	086536	▱	KNIPEX Cobra® Set, 3 parts (1x 87 01 150, 1x 87 01 250, 1x 87 01 300)	1255
00 19 55 S5 LE	082620		Roll-up case for KNIPEX Cobra®, empty, 6 compartments	260
00 19 55 S8 LE	086499		Roll-up case for KNIPEX Cobra®, empty, 4 compartments	220

Set of Circlip Pliers

Compactly packed: four-piece circlip plier sets in practical roll-up bag

- > Tool roll made of hard-wearing polyester fabric
- > With practical, adjustable quick release fastener
- > Dimensions, open (L x H): 315 x 275 mm



00 19 56



00 19 57

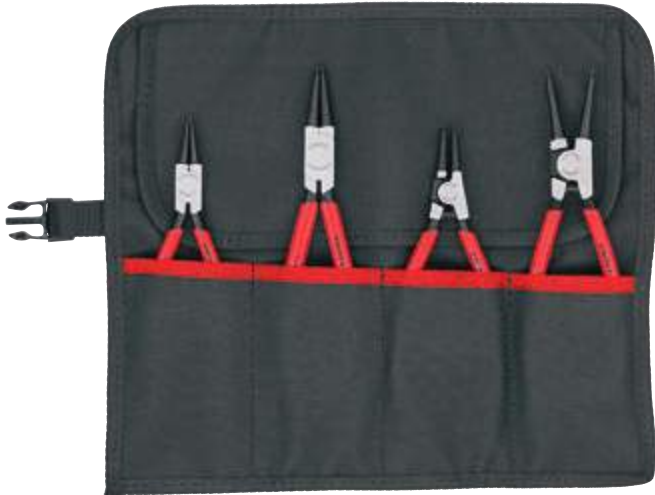

00 19 56 V01



00 19 57 V01

Article No.	EAN			Style	Capacity Ø mm	Tips Ø mm	Number	g
00 19 56	4003773-030973		Set of Circlip Pliers, 4 parts					670
		○	44 11 J2	Circlip Pliers, for internal circlips in bore holes	19 - 60	1.8	1	
		○ ∠90°	44 21 J21	Circlip Pliers, for internal circlips in bore holes	19 - 60	1.8	1	
		○ /MM	46 11 A2	Circlip Pliers, for external circlips on shafts	19 - 60	1.8	1	
		○ ∠90° /MM	46 21 A21	Circlip Pliers, for external circlips on shafts	19 - 60	1.8	1	
00 19 56 V01	081548		Set of Circlip Pliers, 4 parts					615
		○	44 11 J1	Circlip Pliers, for internal circlips in bore holes	12 - 25	1.3	1	
		○	44 11 J2	Circlip Pliers, for internal circlips in bore holes	19 - 60	1.8	1	
		○ /MM	46 11 A1	Circlip Pliers, for external circlips on shafts	10 - 25	1.3	1	
		○ /MM	46 11 A2	Circlip Pliers, for external circlips on shafts	19 - 60	1.8	1	
00 19 57	050056		Set of Circlip Pliers, 4 parts					665
		○	48 11 J1	Circlip Pliers, for internal circlips in bore holes	12 - 25	1.3	1	
		○	48 11 J2	Circlip Pliers, for internal circlips in bore holes	19 - 60	1.8	1	
		○ /MM	49 11 A1	Circlip Pliers, for external circlips on shafts	10 - 25	1.3	1	
		○ /MM	49 11 A2	Circlip Pliers, for external circlips on shafts	19 - 60	1.8	1	
00 19 57 V01	081555		Set of Circlip Pliers, 4 parts					871
		○	48 11 J2	Circlip Pliers, for internal circlips in bore holes	19 - 60	1.3	1	
		○ ∠90°	48 21 J21	Circlip Pliers, for internal circlips in bore holes	19 - 60	1.8	1	
		○ /MM	49 11 A2	Circlip Pliers, for external circlips on shafts	19 - 60	1.3	1	
		○ ∠90° /MM	49 21 A21	Circlip Pliers, for external circlips on shafts	19 - 60	1.8	1	
00 19 56 LE	035954		Tool Roll, empty, 4 compartments					171

Set of Circlip Pliers

Handy storage: eight-piece range in space-saving roll-up bag

- > Tool roll made of hard-wearing polyester fabric
- > With practical, adjustable quick release fastener
- > Dimensions, open (L x H): 610 x 240 mm

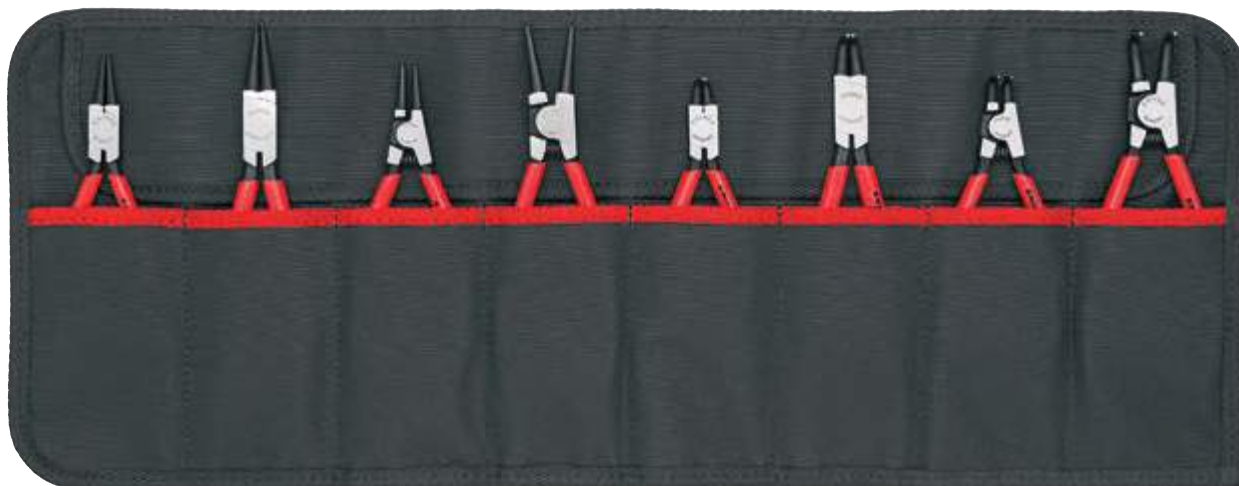

00 19 57 V01



00 19 58 V02

Article No.	EAN			Style	Capacity Ø mm	Tips Ø mm	Number	g
00 19 58 V01	4003773-081562		Set of Circlip Pliers, 8 parts					1156
		⊙	44 11 J1	Circlip Pliers, for internal circlips in bore holes	straight tips	12 - 25	1.3	1
		⊙	44 11 J2			19 - 60	1.8	1
		⊙ ∠90°	44 21 J11		angled tips	12 - 25	1.3	1
		⊙ ∠90°	44 21 J21			19 - 60	1.8	1
		⊙ M	46 11 A1	Circlip Pliers, for external circlips on shafts	straight tips	10 - 25	1.3	1
		⊙ M	46 11 A2			19 - 60	1.8	1
		⊙ ∠90° M	46 21 A11		angled tips	10 - 25	1.3	1
		⊙ ∠90° M	46 21 A21			19 - 60	1.8	1
00 19 58 V02	081579		Set of Circlip Pliers, 8 parts					1357
		⊙	48 11 J1	Circlip Pliers, for internal circlips in bore holes	straight tips	12 - 25	1.3	1
		⊙	48 11 J2			19 - 60	1.8	1
		⊙ ∠90°	48 21 J11		angled tips	12 - 25	1.3	1
		⊙ ∠90°	48 21 J21			19 - 60	1.8	1
		⊙ M	49 11 A1	Circlip Pliers, for external circlips on shafts	straight tips	10 - 25	1.3	1
		⊙ M	49 11 A2			19 - 60	1.8	1
		⊙ ∠90° M	49 21 A11		angled tips	10 - 25	1.3	1
		⊙ ∠90° M	49 21 A21			19 - 60	1.8	1
00 19 58 LE	081920		Tool Roll, empty, 8 compartments					281

Mini Pliers Set XS in belt pouch

Compact. Practical. Robust.

- ▶ Always to hand, always useful: Pliers Wrench XS and KNIPEX Cobra® XS in a practical belt pouch
 - ▶ Tool bag made from durable polyester fabric, with hook-and-loop fastener and belt loop
- > With Pliers Wrench XS: 100 mm tool length, parallel jaw opening gently grips up to 21 mm width across flats
- > With KNIPEX Cobra® XS: 100 mm tool length, grips round workpieces up to 28 mm, with self-locking effect
- > Dimensions (W x H x D): 30 x 110 x 45 mm



00 20 72 V04 XS

00 19 72 XS LE



Large capacity, precise grip: As the jaws always grip in parallel, the Pliers Wrench XS is particularly gentle on hex heads with decorative finishes in sizes up to 21 mm width across flats.

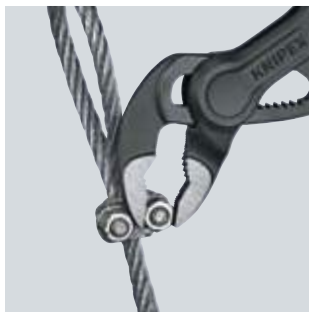

Amazing flexibility: The self-locking effect of the KNIPEX Cobra® XS enables it to grip round materials up to Ø 28 mm extremely reliably – and, due to its very slim head, it can also hold small components in place.

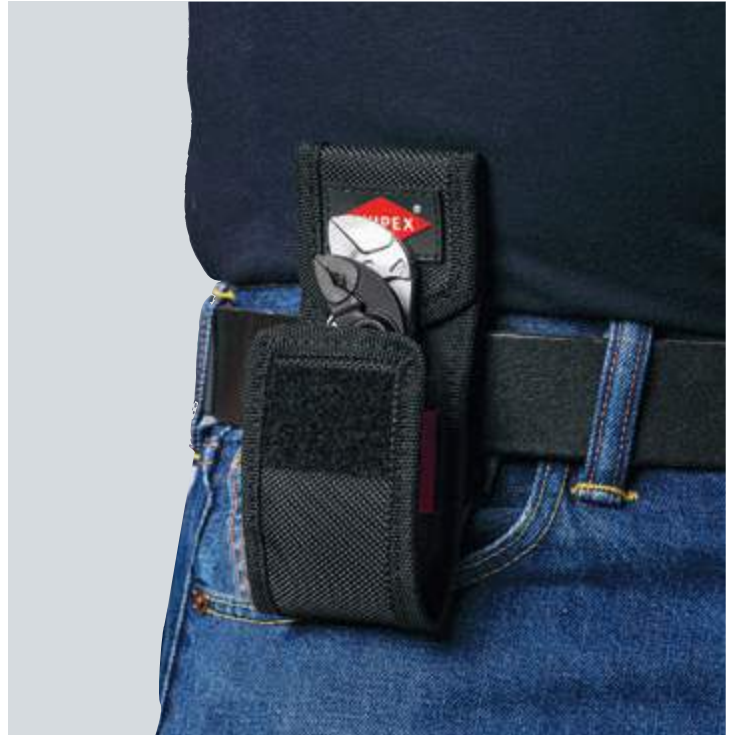

Both tools are held securely in the practical tool bag due to a robust hook-and-loop fastener – and yet close at hand.

Article No.	EAN			Number	g
00 20 72 V04 XS	4003773-087328		Mini Pliers Set XS in belt pouch, 2 parts		175
		PATENTED	86 04 100	Pliers Wrench XS, pliers and a wrench in a single tool	1
		PATENTED	87 00 100	KNIPEX Cobra® XS, Hightech-Water Pump Pliers	1
00 19 72 XS LE	087335		Tool belt pouch, empty	1	45

Mini Pliers Sets

Small pliers for big jobs: mini pliers sets in practical tool belt pouch

- > Tool bag made from durable polyester fabric, with hook-and-loop fastener and belt clip
- > Dimensions (W x H x D): 75 x 180 x 55 mm



00 19 72 V01



00 20 72 V01



00 20 72 V02



00 20 72 V04



00 20 72 V06



KNIPEX Cobra®: with fine adjustment directly on the workpiece

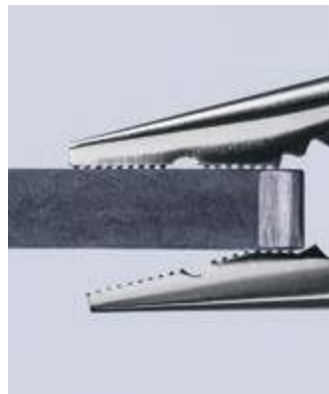

Needle-Nose Combination Pliers: the convex gripping surface on one side makes this the ideal tool for gripping flat parts

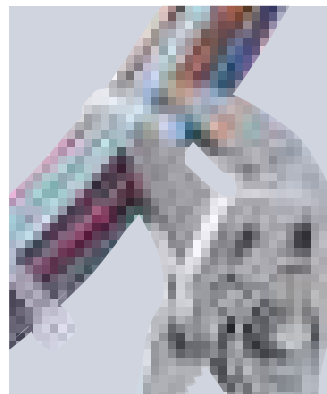

The cable tie can be safely gripped and compressed with the laser-tooled jaws

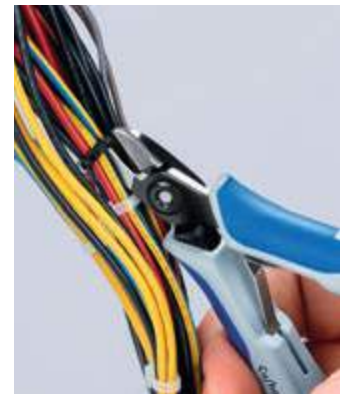

All edges on the pliers head are specially rounded – unintentional damage to the insulation is avoided

Article No.	EAN			Number	g
00 19 72 V01	4003773-070832		Cable Tie Cutting Set, 2 parts		350
			86 03 150 S02 Pliers Wrench	1	
			79 02 125 S1 Precision Electronics Diagonal Cutters	1	
00 20 72 V01	070832		Mini pliers set in belt tool pouch , 2 parts		350
			86 03 150 Pliers Wrench	1	
			87 01 125 KNIPEX Cobra®, Hightech-Water Pump Pliers	1	
00 20 72 V02	075851		Mini pliers set in belt tool pouch , 2 parts		390
			74 01 160 High Leverage Diagonal Cutter	1	
			87 01 150 KNIPEX Cobra®, Hightech-Water Pump Pliers	1	
00 20 72 V04	078920		Mini pliers set in belt tool pouch , 2 parts		264
			86 03 125 Pliers Wrench	1	
			87 01 125 KNIPEX Cobra®, Hightech-Water Pump Pliers	1	
00 20 72 V06	081937		Mini pliers set in belt tool pouch , 2 parts		355
			08 22 145 Needle-Nose Combination Pliers	1	
			87 01 150 KNIPEX Cobra®, Hightech-Water Pump Pliers	1	
00 19 72 LE	070191		Belt Pouch for two pliers up to 160 mm length, empty		65

Case for Electronics Pliers

**Ideal for precision mechanical work:
precision tools in a practical bag**

> Dimensions, closed (W x H x D): 215 x 160 x 50 mm

00 20 16

7 parts, contains 6 electronics pliers and one pair of precision tweezers; case made of hard-wearing polyester fabric, pliers are held by elastic band, zippered



00 20 16

00 20 16 P

6 parts, contains 6 precision electronics pliers; case made of hard-wearing polyester fabric, pliers are held by elastic band, zippered



00 20 16 P

00 20 16 P ESD

6 parts, contains 6 ESD precision electronics pliers, electrically discharging version; case made of hard-wearing polyester fabric, pliers are held by elastic band, zippered



00 20 16 P ESD

00 20 17

6 parts, contains 6 ESD electronics pliers, electrically discharging version; case made of hard-wearing polyester fabric, pliers are held by elastic band, zippered



00 20 17

00 20 18

8 parts, contains 2 electronics pliers and 6 electronics screwdrivers; practical storage box, shock-resistant plastic, with foam insert

00 20 18 ESD

8 parts, contains 2 electronics pliers and 6 electronics screwdrivers, ESD electrically discharging version; practical storage box, shock-resistant plastic, with foam insert



00 20 18



00 20 18 ESD

Article No.	EAN 4003773-	Contents	g
00 20 16	022619	35 12 115 / 35 22 115 / 35 32 115 / 64 32 120 / 77 02 115 / 77 42 115 / 92 34 36	720
00 20 16 P	063223	34 12 130 / 34 22 130 / 34 32 130 / 79 02 120 / 79 02 120 / 79 02 125 / 79 42 125	575
00 20 16 P ESD	063230	34 12 130 ESD / 34 22 130 ESD / 34 32 130 ESD / 79 02 120 ESD / 79 02 125 ESD / 79 42 125 ESD	585
00 20 17	031222	35 12 115 ESD / 35 22 115 ESD / 35 42 115 ESD / 64 32 120 ESD / 77 02 115 ESD / 77 32 115 ESD	695
00 20 18	033073	35 22 115 / 77 02 115 / screw drivers 0,4 x 2,5 / 0,5 x 3,0 / 0,6 x 3,5 / 0,8 x 4,0 / PH0 / PH1	460
00 20 18 ESD	051848	35 22 115 ESD / 77 02 115 ESD / screw drivers 0,4 x 2,5 / 0,5 x 3,0 / 0,6 x 3,5 / 0,8 x 4,0 / PH0 / PH1	465

Pliers Sets in a foam tray

Ideally stored and versatile: plier sets in matching foam insert for workbench and workshop trolley

- > In a foam tray for workbenches and tool trolleys
- > Clearly organised storage of tools
- > Precisely-sized recesses for holding the pliers
- > Foam tray dimensions (W x H x D): 335 x 33 x 165 mm
- > Material: two colour, closed pore foam



00 20 01 V02 Set of pliers "SRZ"



00 20 01 V09 Set of pliers "SRZ II"



00 20 01 V15 Set of pliers "Basic"



00 20 01 V16 Set of pliers "KFZ"

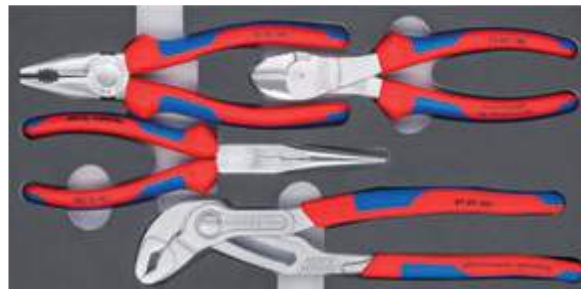

00 20 01 V17 Set of pliers "Basic Chrom"

Article No.	EAN				Number	g
00 20 01 V02	4003773-069652			Set of pliers "SRZ", six precision circlip pliers in a foam tray		915
		☉	48 11 J1	Circlip pliers, for internal circlips in bore holes	1	
			48 11 J2		1	
		☉ 90°	48 21 J21		1	
		☉ M	49 11 A1	Circlip pliers, for external circlips on shafts	1	
			49 11 A2		1	
		☉ M 90°	49 21 A21		1	
00 20 01 V09	073291			Set of pliers "SRZ II", four precision circlip pliers in a foam tray		820
		☉	48 11 J2	Circlip pliers, for internal circlips in bore holes	1	
		☉ 90°	48 21 J21		1	
		☉ M	49 11 A2	Circlip pliers, for external circlips on shafts	1	
		☉ M 90°	49 21 A21		1	
00 20 01 V15	081586			Set of pliers "Basic", four precision circlip pliers in a foam tray		1121
		☉	03 02 180	Combination Pliers	1	
		☉	26 12 200	Snipe Nose Side Cutting Pliers (Stork Beak Pliers)	1	
		☉	74 02 180	High Leverage Diagonal Cutter	1	
		☉	87 01 250	KNIPEX Cobra®, Hightech-Water Pump Pliers	1	
00 20 01 V16	081593			Set of pliers "KFZ", four precision circlip pliers in a foam tray		850
		☉	08 21 145	Needle-Nose Combination Pliers	1	
		☉	74 01 180	High Leverage Diagonal Cutter	1	
		☉	28 71 280	Long Reach Needle Nose Pliers, with transverse profiles	1	
		☉ 45°	28 81 280		1	
00 20 01 V17	081944			Set of pliers "Basic Chrom", four precision circlip pliers in a foam tray		1140
		☉	03 05 180	Combination Pliers	1	
		☉	26 15 200	Snipe Nose Side Cutting Pliers (Stork Beak Pliers)	1	
		☉	74 05 180	High Leverage Diagonal Cutter	1	
		☉	87 05 250	KNIPEX Cobra®, Hightech-Water Pump Pliers	1	

Precision Circlip Pliers Set

- > Attractive sales packaging with Euro standard perforation
- > Contains common Precision Circlip Pliers for highest requirements
- > Sturdy plastic packaging, also suitable for storage of the pliers



00 20 03 SB



00 20 04 SB

Article No.	EAN 4003773-			Style	Capacity Ø mm	Tips Ø mm	Quantity	g	
00 20 03 SB	050100		Precision Circlip Pliers Set					685	
		⊙	48 11 J1	Precision Circlip Pliers, for internal circlips in bore holes	straight tips	12 - 25	1.3		1
			48 11 J2			19 - 60	1.8		1
		⊙	49 11 A1	Precision Circlip Pliers, for external circlips on shafts		10 - 25	1.3		1
			49 11 A2			19 - 60	1.8		1
00 20 04 SB	062417		Precision Circlip Pliers Set						1275
		⊙	48 11 J1	Precision Circlip Pliers, for internal circlips in bore holes	straight tips	12 - 25	1.3	1	
			48 11 J2			19 - 60	1.8	1	
		⊙	49 11 A1	Precision Circlip Pliers, for external circlips on shafts		10 - 25	1.3	1	
			49 11 A2			19 - 60	1.8	1	
		⊙	48 21 J11	Precision Circlip Pliers, for internal circlips in bore holes	angled tips	12 - 25	1.3	1	
			48 21 J21			19 - 60	1.8	1	
		⊙	49 21 A11	Precision Circlip Pliers, for external circlips on shafts		12 - 25	1.3	1	
			49 21 A21			19 - 60	1.8	1	

Set of Circlip Pliers

- > Attractive sales packaging with Euro standard perforation
- > Contains common Circlip Pliers for internal and external circlips
- > Sturdy plastic packaging, also suitable for storage of the pliers



00 20 03 V02

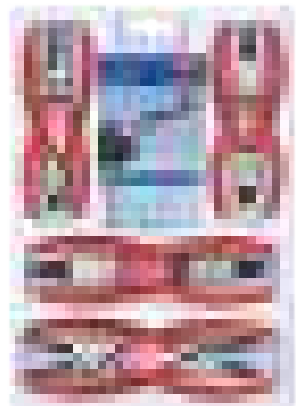

00 20 04 V01

Article No.	EAN 4003773-			Style	Capacity Ø mm	Tips Ø mm	Quantity	g	
00 20 03 V02	077640		Set of Circlip Pliers					450	
		⊙	44 11 J1	Circlip Pliers, for internal circlips in bore holes	straight tips	12 - 25	1.3		1
			44 11 J2			19 - 60	1.8		1
		⊙	46 11 A1	Circlip Pliers, for external circlips on shafts		10 - 25	1.3		1
			46 11 A2			19 - 60	1.8	1	
00 20 04 V01	077633		Set of Circlip Pliers					890	
		⊙	44 11 J1	Circlip Pliers, for internal circlips in bore holes	straight tips	12 - 25	1.3		1
			44 11 J2			19 - 60	1.8		1
		⊙	46 11 A1	Circlip Pliers, for external circlips on shafts		10 - 25	1.3		1
			46 11 A2			19 - 60	1.8		1
		⊙	44 21 J11	Circlip Pliers, for internal circlips in bore holes	angled tips	12 - 25	1.3		1
			44 21 J21			19 - 60	1.8		1
		⊙	46 21 A11	Circlip Pliers, for external circlips on shafts		10 - 25	1.3		1
			46 21 A21			19 - 60	1.8	1	

Tool Sets in a blister



00 31 30 BK V01



00 31 30 BK V02



00 31 30 BK V03

Article No.	EAN			Number	g
00 31 30 BK V01	4003773-086574		Electrical Installations Set, 3 parts		635
		⚡ 1000 V	13 86 200 Pliers for Electrical Installation	1	
		PATENTED	16 95 01 KNIPEX ErgoStrip®, Universal Stripping Tool	1	
		⚡ 1000 V	70 06 160 Diagonal Cutter	1	
00 31 30 BK V02	087892		Electrical Cutting Set, 3 parts		600
		⚡ 1000 V	70 06 160 Diagonal Cutter	1	
		⚡ 1000 V	78 06 125 Electronic Super Knips VDE	1	
		⚡ 1000 V	95 16 160 KNIPEX StepCut® Cable Shears	1	
00 31 30 BK V03	087885		Electrical Cutting Set, 3 parts		760
		⚡ 1000 V	11 06 160 Insulation Stripper	1	
		⚡ 1000 V	26 16 200 Snipe Nose Side Cutting Pliers (Stork Beak Pliers)	1	
		⚡ 1000 V	70 06 160 Diagonal Cutter	1	

Extension sets Electric

Extension set "Electric 1"

Amplify your tool range with 10 additional brand tools

KNIPEX: KNIPEX TwinKey®; VDE High Leverage Diagonal Cutter 200 mm; VDE Snipe Nose Side Cutting Pliers 200 mm, bent; VDE Cable shears 165 ; VDE screwdrivers PlusMinus PZ/S #1; VDE screwdrivers PlusMinus PZ/S #2

Stabila: Pocket Electric

Others: Wooden folding rule 2 m



Extension set "Electric 2"

Amplify your tool range with 13 additional brand tools

KNIPEX: KNIPEX TwinKey®; VDE High Leverage Diagonal Cutter 200 mm; VDE Snipe Nose Side Cutting Pliers 200 mm, bent; VDE Cable shears 165 mm; KNIPEX Cobra® 180 mm; KNIPEX ErgoStrip® – Universal Stripping Tool; VDE Electronic Super Knips; Automatic Insulation Stripper; Crimping Pliers for wire ferrules; VDE screwdrivers PlusMinus PZ/S #1; VDE screwdrivers PlusMinus PZ/S #2

Stabila: Pocket Electric

Others: Wooden folding rule 2 m



Artikel-Nr.	EAN	g
00 20 90 V01	4003773-084693	1415

Artikel-Nr.	EAN	g
00 20 90 V02	4003773-084709	1915

Tool Kits

- > Tools in a plastic deep-drawn tray with transparent lid
- > Attractive sales packaging with Euro standard perforation
- > Dimensions (W x H x D): 170 x 370 x 40 mm



00 20 09 V01 Bestseller-Set

Pliers with polished heads; handles with non-slip plastic coating and with two-colour multi-component grips

Article No.	EAN					Quantity	Nominal size	g
00 20 09 V01	4003773-073994		Bestseller-Set					950
			03 02 180	Combination Pliers	Knipex	1	180 mm	
			70 02 160	Diagonal Cutter		1	160 mm	
			87 01 250	KNIPEX Cobra®, Hightech Water Pump Pliers		1	250 mm	



00 20 09 V02 Cobra® Set

Pliers grey a-ramentized; handles with non-slip plastic coating

Article No.	EAN					Quantity	Nominal size	g
00 20 09 V02	4003773-074793		Cobra® Set					1220
			87 01 180	KNIPEX Cobra®, Hightech Water Pump Pliers	Knipex	1	180 mm	
			87 01 250			1	250 mm	
			87 01 300			1	300 mm	



00 20 09 V03 Alligator® Set

Pliers with polished heads; handles with non-slip plastic coating

Article No.	EAN					Quantity	Nominal size	g
00 20 09 V03	4003773-074809		Alligator® Set					1195
			88 01 180	KNIPEX Alligator®, Water Pump Pliers	Knipex	1	180 mm	
			88 01 250			1	250 mm	
			88 01 300			1	300 mm	



00 20 10 Power Set

Pliers with polished heads and plastic coated handles

Article No.	EAN					Quantity	Nominal size	g
00 20 10	4003773-010388		Power Set					990
			02 01 180	High Leverage Combination Pliers	Knipex	1	180 mm	
			74 01 160	High Leverage Diagonal Cutter		1	160 mm	
			87 01 250	KNIPEX Cobra®, Hightech Water Pump Pliers		1	250 mm	



00 20 11 Assembly Set

Pliers with two-colour multi-component grips

Article No.	EAN 4003773-					Quantity	Nominal size	g
00 20 11	012405		Assembly Set		Knipex			810
			03 02 180	Combination Pliers		1	180 mm	
			26 12 200	Snipe Nose Side Cutting Pliers (Stork Beak Pliers)		1	200 mm	
			70 02 160	Diagonal Cutter	1	160 mm		



00 20 11 V01 Assembly Set

Pliers chrome-plated, with two-colour multi-component grips

Article No.	EAN 4003773-					Quantity	Nominal size	g
00 20 11 V01	064091		Assembly Set		Knipex			874
			03 05 180	Combination Pliers		1	180 mm	
			26 15 200	Snipe Nose Side Cutting Pliers (Stork Beak Pliers)		1	200 mm	
			74 05 180	High Leverage Diagonal Cutter	1	160 mm		



00 20 12 Electric Set

Pliers VDE-tested in conformance with DIN EN/IEC 60900 1000V, pliers chrome-plated, handles with multi-component grips

Article No.	EAN 4003773-					Quantity	Nominal size	g
00 20 12	012412		Electric Set		Knipex			960
			03 06 180	Combination Pliers		1	180 mm	
			26 16 200	Snipe Nose Side Cutting Pliers (Stork Beak Pliers)		1	200 mm	
			70 06 160	Diagonal Cutter	1	160 mm		



00 20 13 VDE Tool Set

Tools VDE-tested in conformance to DIN EN/IEC 60900 1000V, pliers chrome-plated, handles with multi-component covers; with 3 WERA screwdrivers

Article No.	EAN 4003773-					Quantity	Nominal size	g
00 20 13	043287		VDE Tool Set		Knipex			850
			26 16 200	Snipe Nose Side Cutting Pliers (Stork Beak Pliers)		1	200 mm	
			70 06 160	Diagonal Cutter	1	160 mm		
			006110	Screwdrivers for slotted screws, 160i	Wera	1	0.6 x 3.5 x 100 mm	
			006120	Screwdrivers for slotted screws, 160i		1	1.0 x 5.5 x 125 mm	
			006154	Screwdrivers for cross recessed Phillips® screws, 162i PH	1	PH2 x 100 mm		

Tool Kits

- > Tools in a plastic deep-drawn tray with transparent lid
- > Attractive sales packaging with Euro standard perforation
- > Dimensions (W x H x D): 170 x 370 x 40 mm



00 20 12 V01 VDE Screwdriver Set

Tip burnished; insulating multi-component handle, VDE-tested

Article No.	EAN				Quantity	Nominal size	g
00 20 12 V01	4003773-075523			VDE Screwdriver Set			610
			98 20 30	Screwdrivers for slotted screws	Knipex	1	3.0 mm
			98 20 40			1	4.0 mm
			98 20 55			1	5.5 x 125 mm
			98 20 65			1	6,5 mm
			98 24 01	Screwdriver for cross recessed screws, Phillips®	Knipex	1	PH1
			98 24 02			1	PH2



00 20 12 V02 VDE Screwdriver Set Slotted / Phillips®

Tip burnished; insulating multi-component handle, VDE-tested

Article No.	EAN				Quantity	Nominal size	g
00 20 12 V02	4003773-082538			VDE Screwdriver Set Slotted / Phillips®			550
			98 20 30	Screwdrivers for slotted screws	Knipex	1	3.0 mm
			98 20 40 SL			1	4.0 mm
			98 20 55 SL			1	5.5 mm
			98 20 65 SL			1	6.5 mm
			98 24 01 SL	Screwdriver (Slim) for cross-recessed screws, Phillips®	Knipex	1	PH1
			98 24 02 SL			1	PH2



00 20 12 V03 VDE Screwdriver Set Phillips® / Pozidriv®

Tip burnished; insulating multi-component handle, VDE-tested

Article No.	EAN				Quantity	Nominal size	g
00 20 12 V03	4003773-082545			VDE Screwdriver Set Phillips® / Pozidriv®			500
			98 24 00	Screwdriver for cross recessed screws, Phillips®	Knipex	1	PH0
			98 24 01 SL			1	PH1
			98 24 02 SL			1	PH2
			98 25 00	Screwdriver for cross recessed screws, Pozidriv®	Knipex	1	PZ0
			98 25 01 SL			1	PZ1
			98 25 02 SL			1	PZ2



00 20 12 V04 VDE Screwdriver Set Slotted / Phillips® / Pozidriv®

Tip burnished; insulating multi-component handle, VDE-tested

Article No.	EAN 4003773-				Quantity	Nominal size	g
00 20 12 V04	082552			VDE Screwdriver Set Slotted / Phillips® / Pozidriv®			509
			98 20 25	Screwdrivers for slotted screws	Knipex	1	2.5 mm
			98 20 40 SL	Screwdriver (Slim) for slotted screws		1	4.0 mm
			98 24 01 SL	Screwdriver (Slim) for cross-recessed screws, Phillips®		1	PH1
			98 24 02 SL	Screwdriver (Slim) for cross-recessed screws, Phillips®		1	PH2
			98 25 01 SL	Screwdriver (Slim) for cross-recessed screws, Pozidriv®		1	PZ1
			98 25 02 SL	Screwdriver (Slim) for cross-recessed screws, Pozidriv®		1	PZ2



00 20 12 V05 VDE Screwdriver Set PlusMinus / Slotted

Tip burnished; insulating multi-component handle, VDE-tested

Article No.	EAN 4003773-				Quantity	Nominal size	g
00 20 12 V05	082569			VDE Screwdriver Set PlusMinus / Slotted			510
			98 20 25	Screwdrivers for slotted screws	Knipex	1	2.5 mm
			98 20 40 SL	Screwdriver (Slim) for slotted screws		1	4.0 mm
			98 24 01 SLS	(Slim) PlusMinus screwdriver, Phillips®		1	PH/S 1
			98 24 02 SLS	(Slim) PlusMinus screwdriver, Phillips®		1	PH/S 2
			98 25 01 SLS	(Slim) PlusMinus screwdriver, Pozidriv®		1	PZ/S 1
			98 25 02 SLS	(Slim) PlusMinus screwdriver, Pozidriv®		1	PZ/S 2

Pliers Sets

00 31 20 V01

> With KNIPEX Cobra®
87 01 180 and 87 01 250

00 31 20 V02

> With KNIPEX Alligator®
88 01 180 and 88 01 250

00 31 20 V03

> With Pliers Wrench 86 03 180
and KNIPEX Cobra® 87 01 250



00 31 20 V01



00 31 20 V02



00 31 20 V03

Article No.	EAN 4003773-				Quantity	g
00 31 20 V01	077251			Set of pliers		555
	022015		87 01 180	KNIPEX Cobra® Hightech Water Pump Pliers	1	170
	022022		87 01 250	KNIPEX Cobra® Hightech Water Pump Pliers	1	335
00 31 20 V02	077268			Set of pliers		535
	035480		88 01 180	KNIPEX Alligator® Water Pump Pliers	1	180
	022992		88 01 250	KNIPEX Alligator® Water Pump Pliers	1	331
00 31 20 V03	078104			Set of pliers		620
	035466		86 03 180	Pliers Wrench Pliers and a wrench in a single tool	1	230
	022022		87 01 250	KNIPEX Cobra® Hightech Water Pump Pliers	1	335

Tool Box "RED" Electric Set 1

Versatile use: the small four-piece VDE tool range in a handy case

- > High quality, versatile, shock-resistant plastic case
- > Foam insert with honeycomb structure for variable equipment
- > External dimensions (W x H x D): 340 x 56 x 275 mm

00 20 15

Pliers VDE-tested according to DIN EN/IEC 60900 1000V

00 21 15 LE

Box without tools



00 20 15

Article No.	EAN 4003773-				Number	g
00 20 15	024804		Tool Box "RED" Electric Set 1, 4 parts			1430
		⚡ 1000 V ⚡ ⚡ ⚡ ⚡	03 06 180	Combination Pliers	1	
		⚡ 1000 V ⚡ ⚡ ⚡	11 06 160	Insulation Stripper	1	
		⚡ 1000 V ⚡ ⚡ ⚡ ⚡	26 16 200	Snipe Nose Side Cutting Pliers (Stork Beak Pliers)	1	
		⚡ 1000 V ⚡ ⚡ ⚡	70 06 160	Diagonal Cutter	1	
00 21 15 LE	045175		Tool Box "RED", empty			530

Tool Box "RED" Electric Set 2

All you need, safely stored: seven-piece VDE tool set for electrical installation

- > High quality, versatile, shock-resistant plastic case
- > Foam insert with honeycomb structure for variable equipment
- > External dimensions (W x H x D): 340 x 56 x 275 mm

00 21 15

all pliers and screwdrivers except Water Pump Pliers
VDE tested according to DIN EN/IEC 60900

00 21 15 LE

Box without tools



00 21 15

Article No.	EAN 4003773-				Number	Nominal size	g
00 21 15	042853		Tool Box "RED" Electric Set 2, 7 parts				1520
		⚡ 1000 V ⚡ ⚡ ⚡ ⚡	03 06 180	Combination Pliers	KNIPEX	180 mm	
		⚡ 1000 V ⚡ ⚡ ⚡ ⚡	26 16 200	Snipe Nose Side Cutting Pliers (Stork Beak Pliers)		200 mm	
		⚡ 1000 V ⚡ ⚡ ⚡	70 06 160	Diagonal Cutter		160 mm	
		⚡	88 03 180	KNIPEX Alligator®, Water Pump Pliers		180 mm	
		⚡ 1000 V ⚡ ⚡ ⚡		Screwdrivers for slotted screws, 160i	Wera	0.4 x 2.5 x 80 mm	
		⚡ 1000 V ⚡ ⚡ ⚡		Screwdrivers for cross recessed Phillips® screws, 162i PH		0.8 x 4.0 x 100 mm	
		⚡ 1000 V ⚡ ⚡ ⚡		Screwdrivers for cross recessed Phillips® screws, 162i PH		PH1 x 80 mm	
00 21 15 LE	045175		Tool Box "RED", empty				530

Tool Box "SRZ" Precision Circlip Pliers

**Well fixed, safely transported:
Extensive range in handy case**

- > High-quality, impact-resistant plastic case
- > Contains common Precision Circlip Pliers for highest requirements
- > Precisely-sized recesses for holding the pliers
- > Clearly organised storage of tools
- > Dimensions, exterior (W x H x D): 260 x 80 x 210 mm



Article No.	EAN			Style	Capacity Ø mm	Tips Ø mm	Number	△ g
00 21 25	4003773-050131		Tool Box "SRZ", Precision Circlip Pliers					1635
		○	48 11 J1 48 11 J2	straight tips	12 - 25	1.3	1	
			Precision Circlip Pliers for internal circlips in bore holes		19 - 60	1.8	1	
		○ MM	49 11 A1 49 11 A2		10 - 25	1.3	1	
			Precision Circlip Pliers for external circlips on shafts		19 - 60	1.8	1	
		○ ∠90°	48 21 J11 48 21 J21	angled tips	12 - 25	1.3	1	
			Precision Circlip Pliers for external circlips on shafts		19 - 60	1.8	1	
		○ MM ∠90°	49 21 A11 49 21 A21		10 - 25	1.3	1	
			Precision Circlip Pliers for external circlips on shafts		19 - 60	1.8	1	



“Basic”

Solid basis for tool equipment



Tool Case "Basic"

A classic: everything well sorted

- ▶ Two metall tilting locks and three-digit combination lock for secure closing of the lid
- ▶ Label field with two stickers for individual labelling
- ▶ Max. payload: 15 kg
- ▶ Volume: 27 litres

- > Strong, ergonomic handle
- > Heavy duty ABS material, black
- > Circumferential aluminium frame
- > Metal hinges
- > Document compartment in the cover
- > One removable tool board made from dirt-repelling twin-tall PP sheet with 20 tool pockets
- > Base tray, can be fixed by a push button, 50 mm high, can be subdivided by inserts, cover board with 13 large tool pockets and a flat compartment
- > With a total of 41 inserting options



Cover and tool boards made from dirt-repellent PP twin-wall sheets



00 21 05 LE
Case without tools

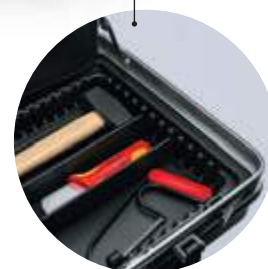

Base tray with separable inserts

Article No.	EAN	Dimension exterior (interior) width mm	Dimension exterior (interior) height mm	Dimension exterior (interior) depth mm	g
00 21 05 LE	4003773-056904	465 (440)	200 (180)	410 (350)	4000

“BIG Basic Move”

Mobile companion
when travelling



Tool Case "BIG Basic Move"

Classic all-rounder with trolley function for working on the move

- ▶ Telescopic handle set in the base as well as two external, smooth-running skater wheels
- ▶ Two metal flip locks and a three-digit combination lock for secure locking of the cover
- ▶ Label field with two stickers for individual labelling
- ▶ Max. payload: 20 kg
- ▶ Volume: 33 litres

- > Strong, ergonomic handle
- > Rugged design made of ABS material, black
- > Circumferential aluminium frame
- > Metal hinges
- > Document compartment in the cover
- > Two removable tool boards made of dirt-repellent PP twin-wall sheets with 31 tool pockets
 - First tool board with ten tool pockets and an elastic strap on the cover side and eleven narrow and one large tool pocket on the base side
 - Second tool board with ten narrow tool pockets and an elastic strap on the base side and document compartment on the cover side
- > Base tray, can be fixed by press button, height 70 mm, can be subdivided by flexible inserts; cover plate with 14 large compartments
- > With a total of 54 inserting options



Tool boards made from dirt-repellent PP twin-wall sheets



Base tray with separable inserts



Extendable telescopic handle



Smooth-running skater wheels

00 21 06 LE
Case supplied without tools



Article No.	EAN	Dimension exterior (interior) width mm	Dimension exterior (interior) height mm	Dimension exterior (interior) depth mm	g
00 21 06 LE	4003773-057512	515 (480)	430 (350)	280 (200)	6200

Tool Case "BIG Basic Move" Electric

The basic mobile tool kit for electricians

- ▶ Equipped with six KNIPEX tools, a total of 24 brand tools, partly VDE-tested according to DIN EN 60900

> For further benefits of the case, see page 299



00 21 06 HL S

Content overview

03 06 180 KNIPEX		98 52 KNIPEX		Rennsteig		Ruthe	
26 16 200 KNIPEX		8 x Wera		Stabila		Ruthe	
11 06 160 KNIPEX		Wera		Picard		maurerfreund	
70 06 160 KNIPEX		Rennsteig		Picard		Haunstätter	
16 20 165 KNIPEX							

Article No.	EAN				Number	Nominal size	g	
00 21 06 HLS	4003773-052296		Tool Case "BIG Basic Move" Electric, 24 parts					9610
			03 06 180	Combination Pliers	KNIPEX	1	180 mm	
			26 16 200	Snipe Nose Side Cutting Pliers (Stork Beak Pliers)		1	200 mm	
			11 06 160	Insulation Stripper		1	160 mm	
			70 06 160	Diagonal Cutter		1	160 mm	
			16 20 165	Dismantling Tool		1	165 mm	
			98 52	Cable Knife	1	185 mm		
				Screwdrivers for slotted screws, 1160i	Wera	1	0.4 x 2.5 x 80 mm	
						1	0.6 x 3.5 x 100 mm	
						1	1.0 x 5.5 x 125 mm	
						1	1.2 x 6.5 x 150 mm	
				Screwdrivers for cross recessed Phillips® screws, 1162i		1	PH1 x 80 mm	
				Screwdrivers for cross recessed Pozidriv® screws, 1165i	1	PH2 x 100 mm		
				Screwdrivers for cross recessed Pozidriv® screws, 1165i	1	PZ1 x 80 mm		
				Voltage detector, single-pole, 247	1	PZ2 x 100 mm		
				Mason's Chisels	Rennsteig	1	0.5 x 3.0 x 70 mm	
				Electrician's Chisel		1	250 mm	
				Carpenter's pencil	Stabila	1	250 x 10 mm	
				Plaster bowl	Picard	1		
				Flat brush		1	127 x 94	
				Locksmith's hammer	Ruthe	1	40 mm	
				Sledge hammer		1	300 g	
				Painter's spatula, wood, high quality	maurerfreund	1	1000 g	
				PUK® Junior Hacksaw	Haunstätter	1	40 mm	
						1	150 x 240 mm	
00 21 06 LE	057512		Tool Case "BIG Basic Move", empty					6200

Tool Case „BIG Basic Move“ ElectricPlus

Premium equipment for professional electricians

- ▶ Equipped with 27 KNIPEX tools, a total of 68 brand tools, partly VDE-tested according to DIN EN 60900

> For further benefits of the case, see page 299



00 21 06

Article No.	EAN				Quantity	Nominal size	g
00 21 06	086260		Tool Case "BIG Basic Move" ElectricPlus, 68 parts				10600
			00 11 01	KNIPEX TwinKey®, Control Cabinet Key	1		
			12 52 195	KNIPEX PreciStrip16	1	195 mm	
		⚡	16 95 01 SB	KNIPEX ErgoStrip®, Universal Stripping Tool	1	135 mm	
		⚡	08 26 145	Needle-Nose Combination Pliers	1	145 mm	
		⚡	13 86 200	Pliers for Electrical Installation	1	200 mm	
		⚡ 40°	26 26 200	Snipe nose pliers, bent	1	200 mm	
		⚡	70 06 160	Diagonal Cutter	1	160 mm	
		⚡	74 06 200	High Leverage Diagonal Cutter	1	200 mm	
		⚡	78 06 125	Electronic Super Knips VDE	1	125 mm	
			87 01 180	KNIPEX Cobra®, Hightech Water Pump Pliers	1	180 mm	
		⚡	97 53 18	KNIPEX Twistor®16 Self-Adjusting Crimping Pliers	1	478 mm	
		⚡	98 20 25	Screwdriver for slotted screws	1	2.5 mm	
			98 20 35 SL	Screwdriver (Slim) for slotted screws	1	0.6 x 3.5 x 100 mm	
		⚡	98 20 40 SL		1	0.8 x 4 x 100 mm	
			98 20 55 SL		1	1.0 x 5.5 x 125 mm	
			98 24 01 SL	Screwdrivers (Slim) for cross-recessed screws, Phillips®	1	PH 1 x 80	
		⚡	98 24 02 SL		1	PH 2 x 100	
			98 25 01 SL		1	PZ 1 x 80	
			98 25 02 SL		1	PZ 2 x 100	
		⚡	98 25 01 SLS	(Slim) PlusMinus screwdriver, Pozidriv®	1	187 mm	
			98 25 02 SLS		1	212 mm	
		⚡	98 26 10	Screwdriver for Torx® screws	1	160 mm TX 10	
			98 26 15		1	185 mm TX 15	
			98 26 20		1	185 mm TX 20	
			98 26 25		1	185 mm TX 25	
			98 26 30		1	210 mm TX 30	
				Folding rule	1	185 mm	
				Pocket Electric mini spirit level	1	430 mm	
				Spirit Level Type 70 Electric	1	400 mm	
				Safety locksmith's hammer, 300 g	1	290 mm	
				Electrician's Chisel	1	250 mm	
				8100 SA 8 Zyklop set of metal ratchets, 28 pieces	1		
				Set of hex key wrenches	1	1.5 - 10 mm	
00 21 06 LE	057512		Tool Case "BIG Basic Move", empty				6200

Tool Case "BIG Basic Move" Mechanics

All-round equipment for professional mechanics

- ▶ Equipped with 12 KNIPEX tools, a total of 90 brand tools, partly VDE-tested according to DIN EN 60900

> For further benefits of the case, see page 299



00 21 06 M

Article No.	EAN				Quantity	Nominal size	⚖ g
00 21 06 M	4003773-086222		Tool Case "BIG Basic Move" Mechanic, 90 parts				12800
			00 11 01	KNIPEX TwinKey®, Control Cabinet Key	KNIPEX	1	
			70 02 160	Diagonal Cutter		1	160 mm
			74 02 200	High Leverage Diagonal Cutter		1	200 mm
			71 31 200	KNIPEX CoBolt Compact Bolt Cutter		1	200 mm
			26 12 200	Snipe Nose Side Cutting Pliers (Stork Beak Pliers)		1	200 mm
			26 22 200	Snipe Nose Side Cutting Pliers (Stork Beak Pliers)		1	200 mm
			78 61 140	Electronic Super Knips XL		1	140 mm
			16 95 01 SB	KNIPEX ErgoStrip®, Universal Stripping Tool		1	135 mm
			16 20 50 SB	Folding Knife for Electricians		1	120 mm
			86 01 250	Pliers Wrench		1	250 mm
			87 01 250	KNIPEX Cobra®, Hightech Water Pump Pliers		1	250 mm
				Folding rule		1	185 mm
				350 PH Screwdriver for Phillips screws	Wera	1	
				917 SPH Screwdriver for Phillips screws Kraftform Plus		1	PH2 x 100 mm
				350 PH Screwdriver for Phillips screws		1	PH3 x 150 mm
						1	PZ1 x 80 mm
				355 PZ Screwdriver for Phillips screws		1	PZ2 x 100 mm
						1	PZ3 x 150 mm
						1	3.5 x 100 mm
				335 Screwdriver for slotted screws - electrician's blade		1	4.0 x 100 mm
				932 A Screwdriver for slotted screws 5.5 Kraftform Plus		1	5.5 x 100 mm
				932 A Screwdriver for slotted screws 7.0 Kraftform Plus		1	7.0 x 125 mm
				932 A Screwdriver for slotted screws 9.0 Kraftform Plus		1	7.0 x 125 mm
						1	TX 10x80
						1	TX 15x80
				367 Screwdriver with holding function for TORX® screws		1	TX 20 x 100
						1	TX 25 x 100
					1	TX 30 x 115	
				Micro screwdriver PH0	1	PH0 x 60 mm	
				Micro screwdriver PH00	1	PH00 x 60 mm	
				Micro screwdriver 1.5	1	1.5 x 60 mm	
				Micro screwdriver 2.5	1	2.5 x 80 mm	
				Locksmith's hammer	Picard	1	300 g
				8100 SA 8 Zyklop set of metal ratchets, 28 pieces	Wera	1	1/4"
				Set of hex key wrenches		1	1.5 - 10 mm
				Spirit level type 70 TM	Stabila	1	220 mm
				Combination wrench sets	Heyco	1	
				Pin punch set	Rennsteig	1	
				Automatic centre punch		1	130 mm
00 21 06 LE	057512		Tool Case "BIG Basic Move", empty				6200

Tool Case "BIG Basic Move" Plumbing

The basic mobile tool kit for plumbing, heating and air-conditioning professionals

► Equipped with 4 KNIPEX tools, a total of 31 brand tools, partly VDE-tested according to DIN EN 60900

> For further benefits of the case, see page 299



00 21 06 HK S

Content overview

70 06 160 KNIPEX		Ruthe		Haunstätter		Stabila	
86 03 250 KNIPEX		Picard		Heyco		Stabila	
88 01 250 KNIPEX		Picard		Picard		9 parts Wera	
88 01 300 KNIPEX		Nölle		Picard		Zenten	
5 x Wera		Heyco		Rennsteig			

Article No.	EAN					Number	Nominal size	g	
00 21 06 HKS	4003773-070825		Tool Case "BIG Basic Move" Plumbing, 31 parts						9800
			70 06 160	Diagonal Cutter	KNIPEX	1	160 mm		
			86 03 250	Pliers Wrench		1	250 mm		
			88 01 250	KNIPEX Alligator®, Water Pump Pliers		1	250 mm		
			88 01 300			1	300 mm		
				Screwdrivers for slotted screws, 1160i	Wera	1	0.6 x 3.5 x 100 mm		
						1	1.0 x 5.5 x 125 mm		
						1	1.2 x 6.5 x 150 mm		
				Screwdrivers for cross recessed Phillips® screws, 1162i		1	PH1 x 80 mm		
				Set of hex key wrenches		1	PH2 x 100 mm		
				Set of hex key wrenches	9	1.5 - 10 mm			
				Locksmith's hammer	Ruthe	1	300 g		
				Flat brush	Picard	1	40 mm		
				Carpenter's pencil	Picard	1	24 cm		
				Plasterer's bowl	Nölle	1	125 x 90 mm		
				Professional utility knife, zinc die casting	Heyco	1	170 mm; 18 mm		
				Express key		1	17 x 19 mm; M 10		
				PUK® Junior Hacksaw	Haunstätter	1	150 x 240 mm		
				Steel wire brush, 5-row	Picard	1	280 mm		
				Painter's spatula		1	40 mm		
				Electrician's Chisel	Rennsteig	1	250 x 10 mm		
				Spirit level type 70	Stabila	1	30 cm		
				Wooden folding rule type 607N		1	2 m		
				Pipe cutter	Zenten	1	3 - 35 mm / 1/8 - 1 1/2"		
00 21 06 LE	057512		Tool Case "BIG Basic Move", empty						6200

"BIG Twin"

Everything at a glance



The design for the "BIG Twin" series

Can be opened on both sides,
generous storage space with
numerous tool pockets



Three-digit combination lock



Label field with two stickers
for individual labelling



Large KNIPEX logo
on the cover



Two metal flip locks



Two deposit recesses
in the case cover



"BIG Twin Move" additionally with trolley function

Smooth-running
skater wheels

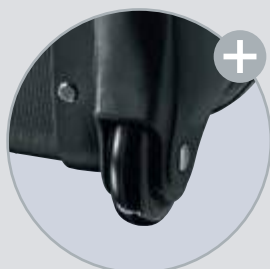

Extendable telescopic
handle



Tool Case "BIG Twin Move"

For quick access: everything at a glance, even on the move

- ▶ Telescopic handle set in the base as well as two external, smooth-running skater wheels
 - ▶ Free-standing in all opening positions thanks to snap-in cover holders with hinge mechanism on both sides, angle freely adjustable
 - ▶ Can be opened from one or both sides; bottom and lid can be opened independently of each other
 - ▶ Label field with two stickers for individual labelling
 - ▶ Max. payload: 30 kg
 - ▶ Volume: 44 litres
-
- > Rugged design made of ABS material, black
 - > Circumferential aluminium frame with securely mounted, sturdy centre wall that can be fitted on both sides, with versatile inserting options due to elasticated loops and twelve small pockets
 - > Metal hinges
 - > Three-digit combination lock for secure locking of the case
 - > Two metal flip locks each for fixing the cover and the base
 - > Removable document compartment and removable tool boards made from dirt-repellent PP twin-wall sheets with 13 tool pockets
 - > Base tray, can be fixed by press button, height 58 mm, can be subdivided by flexible inserts; cover plate with 13 large compartments
 - > With a total of 95 inserting options

Everything at hand thanks to intelligent layout



00 21 41 LE
Case supplied without tools



Extendable telescopic handle



Smooth-running skater wheels



Base tray with handy, robust aluminium dividing bars



"BIG Twin Move RED"
see page 300



Article No.	EAN	Dimension exterior (interior) width mm	Dimension exterior (interior) height mm	Dimension exterior (interior) depth mm	g
00 21 41 LE	4003773-071549	520 (490)	435 (370)	290 (110/100)	8600

Tool Case "BIG Twin Move" Electric

Everything under control, even when on the move: extensive range of tools for the professional electrician

► Equipped with 14 KNIPEX tools, a total of 63 brand tools, partly VDE-tested according to DIN EN 60900

> For further benefits of the case, see page 306



00 21 41

Content overview

00 11 01 KNIPEX		26 26 200 KNIPEX		97 53 04 KNIPEX		Wera	
08 26 145 KNIPEX		70 06 160 KNIPEX		98 52 KNIPEX		Picard	
12 42 195 KNIPEX		74 06 200 KNIPEX		2 x 98 2X XX SL KNIPEX		Rennsteig	
13 86 200 KNIPEX		86 03 180 KNIPEX		16 parts Wera		Stabila	
16 95 01 SB KNIPEX		87 01 180 KNIPEX		28 parts Wera		Stabila	

Article No.	EAN				Number	Nominal size	g
00 21 41	4003773-082118		Tool Case "BIG Twin Move" Electric, 63 parts				13250
		(PATENTED)	00 11 01	KNIPEX TwinKey®, Control Cabinet Key	KNIPEX	1	
		▲ 1000 V ▲	08 26 145	Needle-Nose Combination Pliers		1	145 mm
		MM	12 42 195	KNIPEX MultiStrip 10, Automatic Insulation Stripper		1	195 mm
		▲ 1000 V ▲	13 86 200	Pliers for Electrical Installation		1	200 mm
		MM (PATENTED)	16 95 01 SB	KNIPEX ErgoStrip®, Universal Stripping Tool		1	135 mm
		▲ 1000 V ▲	26 26 200	Snipe Nose Side Cutting Pliers, (Stork Beak Pliers)		1	200 mm
		▲ 1000 V ▲	70 06 160	Diagonal Cutter		1	160 mm
		▲ 1000 V ▲	74 06 200	High Leverage Diagonal Cutter		1	200 mm
		▱	86 03 180	Pliers Wrench		1	180 mm
		MM	87 01 180	KNIPEX Cobra®, Hightech Water Pump Pliers		1	180 mm
		MM (PATENTED)	97 53 04	Self-Adjusting Crimping Pliers for wire end sleeves		1	180 mm
		▲ 1000 V ▲	98 52	Cable Knife		1	185 mm
		▲ 1000 V ▲	98 25 01 SL	Screwdrivers (Slim) for cross-recessed screws, Pozidriv®		1	PZ1 x 80 mm
		▲ 1000 V ▲	98 20 35 SL	Screwdriver (Slim) for slotted screws		1	0,6 x 3,5 x 100 mm
				Kraftform Kompakt VDE 16 extra slim 1, 16 parts	Wera	1	
				Zyklop set of metal ratchets, 8100 SA 8, 28 parts		1	1/4"
				Joker open-end wrench		1	10 x 13 mm
				Locksmith's hammer	Picard	1	300 g
				Electrician's Chisel	Rennsteig	1	250 x 10 mm
				Spirit level type 70 Electric	Stabila	1	430 mm
				Pocket Electric mini spirit level		1	68 mm
00 21 41 LE	071549		Tool Case "BIG Twin Move", empty				8600

Tool Case "BIG Twin"

**For quick access:
everything at a glance**

- ▶ Free-standing in all opening positions thanks to snap-in cover holders with hinge mechanism on both sides, angle freely adjustable
- ▶ Can be opened from one or both sides; bottom and lid can be opened independently of each other
- ▶ Label field with two stickers for individual labelling
- ▶ Max. payload: 25 kg
- ▶ Volume: 44 litres

- > Rugged design made of ABS material, black
- > Circumferential aluminium frame with securely mounted, sturdy centre wall that can be fitted on both sides, with versatile inserting options due to elasticated loops and twelve small pockets
- > Metal hinges
- > Three-digit combination lock for secure locking of the case
- > Two metal flip locks each for fixing the cover and the base
- > Removable document compartment and removable tool boards made from dirt-repellent PP twin-wall sheets with 13 tool pockets
- > Base tray, can be fixed by press button, height 58 mm, can be subdivided by flexible inserts; cover plate with 13 large compartments
- > With a total of 95 inserting options

Everything at hand thanks to intelligent layout

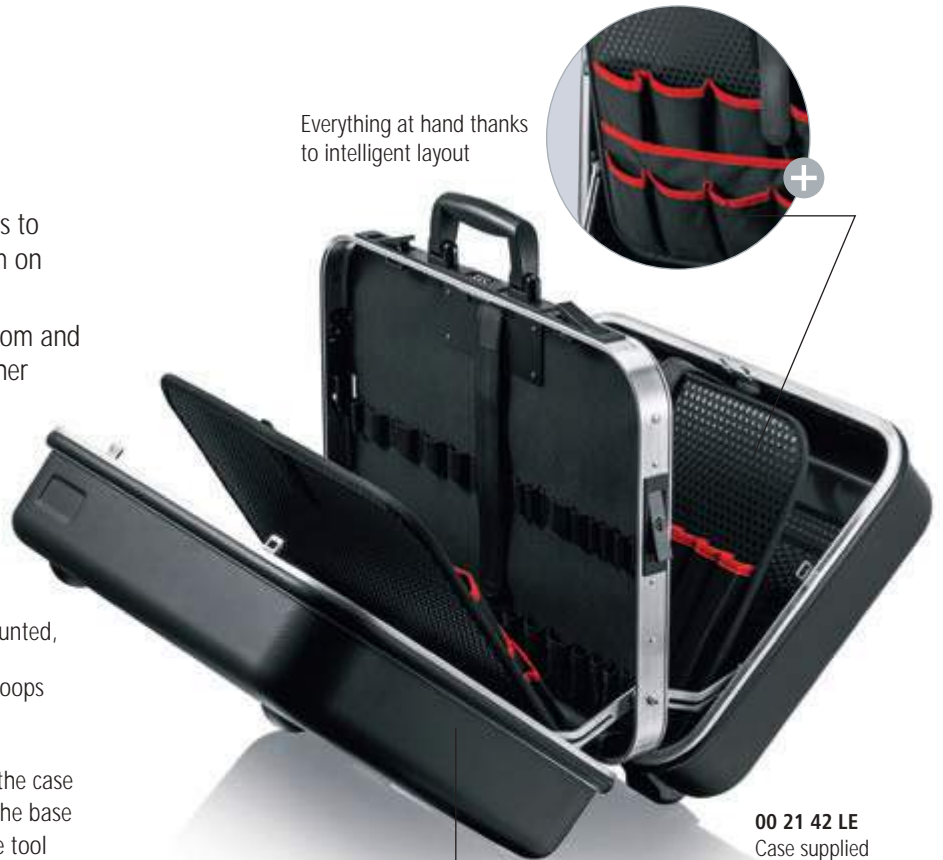

+

00 21 42 LE
Case supplied without tools



Base tray with handy, robust aluminium dividing bars



Article No.	EAN	Dimension exterior (interior) width mm	Dimension exterior (interior) height mm	Dimension exterior (interior) depth mm	g
00 21 42 LE	084211	520 (490)	435 (370)	250 (110/100)	7200

Tool Case "BIG Twin" Electric

Always at hand: extensive range of tools for the professional electrician

- ▶ Equipped with 14 KNIPEX tools, a total of 63 brand tools, partly VDE-tested according to DIN EN 60900

> For further benefits of the case, see page 308



Content overview

00 11 01 KNIPEX		26 26 200 KNIPEX		97 53 04 KNIPEX		Wera	
08 26 145 KNIPEX		70 06 160 KNIPEX		98 52 KNIPEX		Picard	
12 42 195 KNIPEX		74 06 200 KNIPEX		2 x 98 2X XX SL KNIPEX		Rennsteig	
13 86 200 KNIPEX		86 03 180 KNIPEX		16 parts Wera		Stabila	
16 95 01 SB KNIPEX		87 01 180 KNIPEX		28 parts Wera		Stabila	

Article No.	EAN				Number	Nominal size	g
00 21 42	4003773-081968		Tool Case "BIG Twin" Electric, 63 parts				11400
			00 11 01	KNIPEX TwinKey®, Control Cabinet Key	KNIPEX	1	
			08 26 145	Needle-Nose Combination Pliers		1	145 mm
			12 42 195	KNIPEX MultiStrip 10, Automatic Insulation Stripper		1	195 mm
			13 86 200	Pliers for Electrical Installation		1	200 mm
			16 95 01 SB	KNIPEX ErgoStrip®, Universal Stripping Tool		1	135 mm
			26 26 200	Snipe Nose Side Cutting Pliers, (Stork Beak Pliers)		1	200 mm
			70 06 160	Diagonal Cutter		1	160 mm
			74 06 200	High Leverage Diagonal Cutter		1	200 mm
			86 03 180	Pliers Wrench		1	180 mm
			87 01 180	KNIPEX Cobra®, Hightech Water Pump Pliers		1	180 mm
			97 53 04	Self-Adjusting Crimping Pliers for wire end sleeves		1	180 mm
			98 52	Cable Knife		1	185 mm
			98 25 01 SL	Screwdrivers (Slim) for cross-recessed screws, Pozidriv®		1	PZ 1 x 80 mm
			98 20 35 SL	Screwdriver (Slim) for slotted screws		1	0,6 x 3,5 x 100 mm
			Kraftform Kompakt VDE 16 extra slim 1, 16 parts		Wera	1	
			Zyklop set of metal ratchets, 8100 SA 8, 28 parts			1	1/4"
			Joker open-end wrench		1	10 x 13 mm	
			Locksmith's hammer		Picard	1	300 g
			Electrician's Chisel		Rennsteig	1	250 x 10 mm
			Spirit level type 70 Electric		Stabila	1	430 mm
			Pocket Electric mini spirit level			1	68 mm
00 21 42 LE	084211		Tool Case "BIG Twin", empty				7200



Tool Case "BIG Twin Move RED" Electric Competence

Better safe than sorry: 47 insulated brand tools for work on electrical systems

- ▶ Hard-wearing ABS material construction, red; equipped with a range of KNIPEX tools for working on electrical systems, tested according to DIN EN/IEC 60900
 - ▶ Telescopic handle set in the base as well as two external, smooth-running skater wheels
 - ▶ Free-standing in all opening positions thanks to snap-in cover holders with hinge mechanism on both sides, angle freely adjustable
 - ▶ Can be opened from one or both sides; bottom and lid can be opened independently of each other
 - ▶ Max. payload: 30 kg
 - ▶ Volume: 44 litres
- > Label field with two stickers for individual labelling
 - > Circumferential aluminium frame with securely mounted, sturdy centre wall that can be fitted on both sides, with versatile inserting options due to elasticated loops and twelve small pockets
 - > Metal hinges
 - > Three-digit combination lock for secure locking of the case
 - > Two metal flip locks each for fixing the cover and the base
 - > Removable document compartment and removable tool boards made from dirt-repellent PP twin-wall sheets with 13 tool pockets
 - > Base tray, can be fixed by press button, height 58 mm, can be subdivided by flexible inserts; cover plate with six large compartments
 - > Dimensions, exterior (W x H x D): 520 x 435 x 290 mm
Dimensions, interior (W x H x D): 490 x 370 x 110/100 mm
 - > IEC 60900, DIN EN 60900
 - > With a total of 95 inserting options



























































98 99 15



98 99 15 LE
Case supplied without tools

Content overview

70 06 160 KNIPEX		6 x 98 00 XX KNIPEX		9 x 98 47 XX KNIPEX		98 25 02 SLS KNIPEX	
08 26 145 KNIPEX		6 x 98 01 XX KNIPEX		6 x 98 64 02 KNIPEX		2 x 98 24 XX SL KNIPEX	
11 06 160 KNIPEX		98 42 KNIPEX		98 20 25 KNIPEX		98 52 KNIPEX	
87 26 250 KNIPEX		98 40 KNIPEX		3 x 98 20 XX SL KNIPEX		98 53 03 KNIPEX	
95 16 200 KNIPEX		2 x 98 45 XXX KNIPEX		2 x 98 25 XX SL KNIPEX			

Article No.	EAN 4003773-				Number	Nominal size	g
98 99 15	084341		Tool Case "BIG Twin Move RED", 47 parts				15450
		  	08 26 145	Needle-Nose Combination Pliers	1	145 mm	
		 	11 06 160	Insulation Stripper	1	160 mm	
		  	70 06 160	Diagonal Cutter	1	160 mm	
		  	87 26 250	KNIPEX Cobra®, Hightech Water Pump Pliers	1	250 mm	
		  	95 16 200	Cable Shears with twin cutting edge	1	200 mm	
			98 00 10	Open-end wrench	1	10 mm	
			98 00 13		1	13 mm	
			98 00 14		1	14 mm	
			98 00 17		1	17 mm	
			98 00 19		1	19 mm	
		 	98 00 22	Box Wrench	1	22 mm	
			98 01 10		1	10 mm	
			98 01 13		1	13 mm	
			98 01 14		1	14 mm	
			98 01 17		1	17 mm	
			98 01 19		1	19 mm	
			98 01 22		1	22 mm	
			98 20 25	Screwdrivers for slotted screws	1	0.4 x 2.5 x 75 mm	
		  	98 20 40 SL	Screwdriver (Slim) for slotted screws	1	0.8 x 4.0 x 100 mm	
			98 20 55 SL		1	1.0 x 5.5 x 125 mm	
			98 20 65 SL		1	1.2 x 6.5 x 150 mm	
		  	98 25 01 SL	Screwdrivers (Slim) for cross-recessed screws, Pozidriv®	1	PH1 x 80 mm	
			98 25 02 SL		1	PH2 x 100 mm	
		  	98 25 02 SLS	Screwdrivers (Slim) Plus/Minus Pozidriv®	1	PZ/S 2 x 100	
		  	98 24 01 SL	Screwdrivers (Slim) for cross-recessed screws Phillips®	1	PH1 x 80 mm	
			98 24 02 SL		1	PH2 x 100 mm	
		 	98 40	T-Handle Drive with driving square 1/2"	1	165 mm	
		 	98 42	Reversible Ratchet with driving square 1/2"	1	1/2"	
		  	98 45 125	Extension Bar with internal/external square 1/2"	1	1/2"	
			98 45 250		1	1/2"	
			98 47 10	Hexagon Socket for hexagonal screws with internal square 1/2"	1	1/2" / 10 mm	
			98 47 11		1	1/2" / 11 mm	
			98 47 12		1	1/2" / 12 mm	
			98 47 13		1	1/2" / 13 mm	
			98 47 14		1	1/2" / 14 mm	
			98 47 17		1	1/2" / 17 mm	
			98 47 19		1	1/2" / 19 mm	
			98 47 22		1	1/2" / 22 mm	
			98 47 24		1	1/2" / 24 mm	
		 	98 52		Cable Knife	1	185 mm
			98 53 03	Dismantling Knife for round cables	1	155 mm	
		 	98 64 02	Insulating Clamp of plastic	6	150 mm	
98 99 15 LE	084334		Tool Case "BIG Twin Move RED", empty				8600

"Robust"

Optimum tool transport even under the toughest conditions



Tool Case "Robust"

The name says it all: ideal for outdoor use

- ▶ For the toughest conditions: Dust-tight, waterproof and temperature-resistant
- > Fit-to-fly case, made from impact-resistant polypropylene
- > Dustproof and watertight
- > Air pressure compensation valve
- > Temperature-resistant from -30°C until + 80°C
- > Padlock eyelets
- > Document compartment; tool boards made from dirt-repellent PP twin-wall sheets with tool pockets and straps
- > Lockable base tray can be individually divided using aluminium separator system
- > Ergonomic dual-component handle



Pressure valve for venting and name plate for individual labelling



Document compartment





Device for securing with a padlock (lock not included)



Aluminium separators for individual division of the base tray

The "Robust" cases compared:

		Number of inserting options	Litre capacity	Max. payload kg	Dimensions base tray mm	Trolley function
"Robust23" 00 21 35 LE		49	23	25	470 x 370 x 190	–
"Robust34" 00 21 36 LE		93	34	25	510 x 419 x 215	–
"Robust45 Move" 00 21 37 LE		147	45	35	609 x 428 x 263	✓



Also suitable as a standing or sitting aid



Case locking via robust flip locks



Secure fastening of the tool board prevents tools from falling out of the base

Tool Case "Robust23" Electric

Small and robust: handy case with tools for professional electricians

- ▶ Equipped with 25 brand tools, partly VDE-tested according to DIN EN 60900
- ▶ Max. payload: 25 kg
- ▶ Volume: 23 litres

- > Document compartment; tool boards made from dirt-repelling twin-wall PP sheets with space for 33 tool pockets and various tool straps
- > With a total of 49 inserting options
- > Base tray with aluminium separators
- > Dimensions, exterior (W x H x D): 470 x 370 x 190 mm
- > Dimensions, interior (W x H x D): 437 x 307 x 172 mm

- > **For further benefits of the case, see page 313**

00 21 35 LE
Case supplied without tools



00 21 35

Content overview

12 40 200 KNIPEX		70 06 160 KNIPEX		97 53 04 KNIPEX		16 parts Wera	
13 86 200 KNIPEX		87 01 180 KNIPEX		98 52 KNIPEX		Stabila	
16 95 01 SB KNIPEX							



With adjustable carrying strap and comfortable multi-component handle



002135 LE – Case supplied without tools

Article No.	EAN				Number	Nominal size	g
00 21 35	4003773-084365		Tool Case "Robust23" Electric, 25 parts				6800
		MM	12 40 200	Self-Adjusting Insulation Stripper	KNIPEX	1	200 mm
		⚠ 1000 V ⚡ ⚙️	13 86 200	Pliers for Electrical Installation		1	200 mm
		MM (PATENTED)	16 95 01 SB	KNIPEX ErgoStrip® Universal Stripping Tool		1	135 mm
		⚠ 1000 V ⚡ ⚙️	70 06 160	Diagonal Cutter		1	160 mm
		MM	87 01 180	KNIPEX Cobra®, Hightech Water Pump Pliers		1	180 mm
		MM (PATENTED)	97 53 04	Self-Adjusting Crimping Pliers for wire end sleeves		1	180 mm
		⚠ 1000 V ⚡ ⚙️	98 52	Cable Knife		1	190 mm
				Kraftform Kompakt VDE 16 extra slim 1, 16 parts		Wera	1
				Ruler Stabila Serie 400	Stabila	1	185 mm
00 21 35 LE	077596		Tool Case "Robust23", empty				4800

Tool Case "Robust34" Electric

Medium-sized and robust: sturdy case with tools for professional electricians

- ▶ Equipped with 26 brand tools, partly VDE-tested according to DIN EN 60900
- ▶ Max. payload: 25 kg
- ▶ Volume: 34 litres

- > Document compartment; tool boards made from dirt-repelling twin-wall PP sheets with space for 38 tool pockets and various tool straps
- > With a total of 93 inserting options
- > Base tray with aluminium separators
- > Dimensions, exterior (W x H x D): 510 x 419 x 215 mm
- > Dimensions, interior (W x H x D): 480 x 356 x 199 mm

> **For further benefits of the case, see page 313**

00 21 36 LE
Case supplied without tools



00 21 36

Content overview

00 11 01 KNIPEX		13 86 200 KNIPEX		87 01 180 KNIPEX		16 parts Wera	
08 26 145 KNIPEX		16 95 01 SB KNIPEX		97 53 04 KNIPEX		Stabila	
12 40 200 KNIPEX		70 06 160 KNIPEX		98 52 KNIPEX			



With adjustable carrying strap and comfortable multi-component handle



002136 LE – Case supplied without tools



Article No.	EAN				Number	Nominal size	g
00 21 36	4003773-082583		Tool Case "Robust34" Electric, 26 parts				10000
		(PATENTED)	00 11 01	KNIPEX TwinKey®, Control Cabinet Key	KNIPEX		
		⚠ 1000 V ⚠	08 26 145	Needle-Nose Combination Pliers		1	145 mm
		MM	12 40 200	Self-Adjusting Insulation Stripper		1	200 mm
		⚠ 1000 V ⚠	13 86 200	Pliers for Electrical Installation		1	200 mm
		MM (PATENTED)	16 95 01 SB	KNIPEX ErgoStrip®, Universal Stripping Tool		1	135 mm
		⚠ 1000 V ⚠	70 06 160	Diagonal Cutter		1	160 mm
		MM	87 01 180	KNIPEX Cobra®, Hightech Water Pump Pliers		1	180 mm
		MM (PATENTED)	97 53 04	Self-Adjusting Crimping Pliers for wire end sleeves with lateral access		1	180 mm
		⚠ 1000 V ⚠	98 52	Cable Knife		1	185 mm
		⚠ 1000 V ⚠		Kraftform Kompakt VDE 16 extra slim 1, 16 parts	Wera	1	
				Spirit level type 70 Electric	Stabila	1	430 mm
00 21 36 LE	082576		Tool Case "Robust34", empty				7100

Tool Case "Robust45 Move" Electric

Large and robust: travel case with a comprehensive range of tools for the mobile electrician

- ▶ Extensively equipped with 63 brand tools, partly VDE-tested according to DIN EN 60900
 - ▶ Max. payload: 35 kg
 - ▶ Volume: 45 litres
- > Gas pressure absorber in the hinge
 - > Pneumatically cushioned lid
 - > Document compartment; tool boards made from dirt-repelling twin-wall PP sheets with space for 46 tool pockets and various tool straps
 - > With a total of 147 inserting options
 - > Base tray with aluminium separators
 - > Extendable telescopic handle for comfortable transport
 - > Large smooth-running wheels
 - > Dimensions, exterior (W x H x D): 609 x 428 x 263 mm
 - > Dimensions, interior (W x H x D): 540 x 364 x 229 mm
- > **For further benefits of the case, see page 313**

00 21 37 LE
Case supplied without tools

Gas pressure absorber in the hinge: convenient opening of the lid, with no risk of injury from the case closing inadvertently



With large smooth-running wheels



00 21 37



Extendable telescopic handle

Content overview

00 11 01 KNIPEX		26 26 200 KNIPEX		97 53 04 KNIPEX		Wera	
08 26 145 KNIPEX		70 06 160 KNIPEX		98 52 KNIPEX		16 parts Wera	
12 42 195 KNIPEX		74 06 200 KNIPEX		2 x 98 2X XX SL KNIPEX		Stabila	
13 86 200 KNIPEX		86 03 180 KNIPEX		Picard		Stabila	
16 95 01 SB KNIPEX		87 01 180 KNIPEX		Wera		Rennsteig	



Handles on left and right permit comfortable carrying with two people



With telescopic handle for comfortable transport – even on uneven terrain



002137 LE – Case supplied without tools

Article No.	EAN				Number	Nominal size	g
00 21 37	4003773-082606		Tool Case "Robust45 Move" Electric, 63 parts				15000
			00 11 01	KNIPEX TwinKey®, Control Cabinet Key	KNIPEX	1	
			08 26 145	Needle-Nose Combination Pliers		1	145 mm
			12 42 195	KNIPEX MultiStrip 10, Automatic Insulation Stripper		1	195 mm
			13 86 200	Pliers for Electrical Installation		1	200 mm
			16 95 01 SB	KNIPEX ErgoStrip®, Universal Stripping Tool		1	135 mm
			26 26 200	Snipe Nose Side Cutting Pliers		1	200 mm
			70 06 160	Diagonal Cutter		1	160 mm
			74 06 200	High Leverage Diagonal Cutter		1	200 mm
			86 03 180	Pliers Wrench		1	180 mm
			87 01 180	KNIPEX Cobra®, Hightech Water Pump Pliers		1	180 mm
			97 53 04	Self-Adjusting Crimping Pliers for wire end sleeves		1	180 mm
			98 52	Cable Knife		1	190 mm
			98 25 01 SL	VDE-screwdriver PZ1		1	PZ1 x80mm
			98 20 35 SL	VDE-screwdriver 3,5		1	0,6 x 3,5 x 100 mm
				Locksmith's hammer, 300g	Picard	1	
				Zyklus set of metal ratchets, 8100 SA 8, 28 parts		1	1/4"
				Joker open-end wrench	Wera	1	10x13 mm
				Kraftform Kompakt VDE 16 extra slim 1, 16 parts		1	
				Pocket Electric spirit level	Stabila	1	68 mm
				Spirit level type 70 Electric		1	430 mm
				Electrician's Chisel	Rennsteig	1	250x10mm
00 21 37 LE	082590		Tool Case "Robust45 Move", empty				10800

Tool Case "Robust45 Move" Mechanics

All-round equipment for professional mechanics

- ▶ Extensively equipped with 90 brand tools, partly VDE-tested according to DIN EN 60900
- ▶ Max. payload: 35 kg
- ▶ Volume: 45 litres

- > Gas pressure absorber in the hinge
- > Pneumatically cushioned lid
- > Document compartment; tool boards made from dirt-repelling twin-wall PP sheets with space for 46 tool pockets and various tool straps
- > With a total of 147 inserting options
- > Base tray with aluminium separators
- > Extendable telescopic handle for comfortable transport
- > Large smooth-running wheels
- > Dimensions, exterior (W x H x D): 609 x 428 x 263 mm
- > Dimensions, interior (W x H x D): 540 x 364 x 229 mm

> For further benefits of the case, see page 313

00 21 37 LE
Case supplied without tools

Gas pressure absorber in the hinge: convenient opening of the lid, with no risk of injury from the case closing inadvertently



00 21 37 M



With large smooth-running wheels

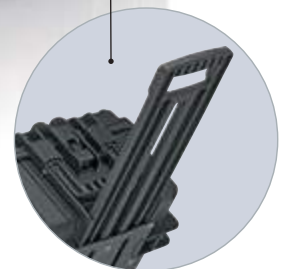

Extendable telescopic handle

Content overview

00 11 01 KNIPEX		26 22 200 KNIPEX		20 x Wera		Stabila	
70 02 160 KNIPEX		78 61 140 KNIPEX		Picard		Heyco	
74 02 200 KNIPEX		16 95 01 SB KNIPEX		Wera		Rennsteig	
71 31 200 KNIPEX		16 20 50 SB KNIPEX		Wera		Rennsteig	
26 12 200 KNIPEX		86 01 250 KNIPEX		Stabila			

Article No.	EAN					Number	Nominal size	⚖ g
00 21 37 M	4003773-086222		Tool Case "Robust45 Move" Mechanics, 90 parts					12800
			00 11 01	KNIPEX TwinKey®, Control Cabinet Key	KNIPEX	1		
			70 02 160	Diagonal Cutter		1	160 mm	
			74 02 200	High Leverage Diagonal Cutter		1	200 mm	
			71 31 200	KNIPEX CoBolt Compact Bolt Cutters		1	200 mm	
			26 12 200	Snipe Nose Side Cutting Pliers		1	200 mm	
			26 22 200	Snipe Nose Side Cutting Pliers		1	200 mm	
			78 61 140	Electronic Super Knips XL		1	140 mm	
			16 95 01 SB	KNIPEX ErgoStrip®, Universal Stripping Tool		1	135 mm	
			16 20 50 SB	Folding Knife for Electricians		1	120 mm	
			86 01 250	Pliers Wrench		1	250 mm	
			87 01 250	KNIPEX Cobra®, Hightech Water Pump Pliers	1	250 mm		
				350 PH Screwdriver for Phillips screws	Wera	1	PH1 x 80 mm	
				917 SPH Screwdriver for Phillips screws		1	PH2 x 100 mm	
				350 PH Screwdriver for Phillips screws		1	PH3 x 150 mm	
				355 PZ Screwdriver for Phillips screws		1	PZ1 x 80 mm	
				355 PZ Screwdriver for Phillips screws		1	PZ2 x 100 mm	
				355 PZ Screwdriver for Phillips screws		1	PZ3 x 150 mm	
				335 Screwdriver for slotted screws		1	3.5 x 100 mm	
				335 Screwdriver for slotted screws		1	4.0 x 100 mm	
				932 A Screwdriver for slotted screws		1	5.5 x 100 mm	
				932 A Screwdriver for slotted screws		1	7.0 x 125 mm	
				932 A Screwdriver for slotted screws		1	7.0 x 125 mm	
				367 Screwdriver for TORX® screws		1	TX 10x80	
				367 Screwdriver for TORX® screws		1	TX 15x80	
				367 Screwdriver for TORX® screws		1	TX 20x100	
				367 Screwdriver for TORX® screws		1	TX 25x100	
				367 Screwdriver for TORX® screws		1	TX 30x115	
				2050 Screwdriver for Phillips screws		1	PH0 x 60 mm	
				2050 Screwdriver for Phillips screws		1	PH00 x 60 mm	
				2035 Screwdriver for slotted screws	1	1.5 x 60 mm		
				2035 Screwdriver for slotted screws	1	2.5 x 80 mm		
				Locksmith's hammer	Picard	1	300 g	
				8100 SA 8 Zyklop set of metal ratchets, 28 parts	Wera	1	1/4"	
				Set of hex key wrenches		1	1.5 - 10 mm	
				Wooden folding rule	KNIPEX	1	185 mm	
				Spirit level type 70 Electric	Stabila	1	430 mm	
				Combination wrench set	Heyco	1		
				Set of parallel pin punches	Rennsteig	1		
				Automatic centre punch		1	130 mm	
00 21 37 LE	082590		Tool Case "Robust45 Move", empty					10800

Tool Case "Vision24" Electric

Well sorted and tidy: the standard tool case with versatile basic equipment

- ▶ Equipped with 20 brand tools, partly VDE-tested according to DIN EN 60900
- ▶ Max. payload: 20 kg
- ▶ Volume: 24 litres
- > Flexible options due to the individual partitioning of the inserts in the 60 mm deep base tray and its cover plate with six large tool compartments
- > Tough ratchet hinges hold the lid open where necessary despite the deadweight of the tools
- > Strong, ergonomic handle, snaps into place at a 90° angle
- > Removable tool board with 15 tool pockets on the base side and six tool pockets as well as a clamp compartment (400 mm wide) on the cover side, held by a push button
- > Two lockable steel flip locks protect the case contents from theft
- > With circumferential double aluminium frame
- > Rugged design made of ABS material, black
- > Cover and tool boards made from dirt-repellent PP twin-wall sheets
- > Dimensions, exterior (W x H x D): 480 x 380 x 180 mm
Dimensions, interior (W x H x D): 460 x 310 x 170 mm



00 21 20



00 21 20 LE
Case supplied without tools

Article No.	EAN				Number	Nominal size	g
00 21 20	4003773-052166		Tool Case "Vision24" Electric, 20 parts				7225
		⚡ 1000 V	03 06 180	Combination Pliers	1	180 mm	
		⚡	12 40 200	Self-Adjusting Insulation Stripper	1	200 mm	
		⚡ (PATENTED)	16 95 01 SB	KNIPEX ErgoStrip®, Universal Stripping Tool	1	135 mm	
		⚡ 1000 V	26 16 200		1	200 mm	
		⚡ 1000 V	26 26 200	Snipe Nose Side Cutting Pliers (Stork Beak Pliers)	1	200 mm	
		⚡ 1000 V	70 06 160	Diagonal Cutter	1	160 mm	
		⚡	74 06 200	High Leverage Diagonal Cutter	1	200 mm	
			86 03 180	Pliers Wrench	1	180 mm	
			87 03 250	KNIPEX Cobra®, Hightech Water Pump Pliers	1	250 mm	
		⚡ 1000 V	95 16 200	Cable Shears with twin cutting edge	1	200 mm	
		⚡ 1000 V	98 20 25	Screwdrivers for slotted screws	1	0.6 x 3.5 x 100 mm	
			98 20 65 SL		1	1.2 x 6.5 x 150 mm	
		⚡ 1000 V	98 20 55 SL	Screwdriver (Slim) for slotted screws	1	1.0 x 5.5 x 125 mm	
			98 20 40 SL		1	0.6 x 3.5 x 100 mm	
		⚡ 1000 V	98 24 01 SL	Screwdrivers for cross recessed Phillips® screws	1	PH1 x 80 mm	
			98 24 02 SL		1	PH2 x 80 mm	
		⚡ 1000 V	98 25 01 SL	Screwdrivers for cross recessed Pozidriv® screws	1	PZ1 x 80 mm	
			98 25 02 SL		1	PZ2 x 80 mm	
		⚡ 1000 V	98 52	Cable Knife	1	185 mm	
		⚡		Voltage detector, single-pole, 247	1	0.5 x 3.0 x 70 mm	
00 21 20 LE	044567		Tool Case "Vision24", empty				4485

Tool Case "Vision27" Plumbing

Flexible and extensively equipped: large plumbing range for professionals

- ▶ Equipped with 52 brand tools, partly VDE-tested according to DIN EN 60900
- ▶ Max. payload: 20 kg
- ▶ Volume: 27 litres

- > For extensive plumbing and installation work
- > Flexible options due to the individual partitioning of the inserts in the 60 mm deep base tray and its cover plate with six large tool compartments
- > Tough ratchet hinges hold the lid open where necessary despite the deadweight of the tools
- > Strong, ergonomic handle, snaps into place at a 90° angle
- > Removable tool board with 15 tool pockets on the base side and six tool pockets as well as a clamp compartment (400 mm wide) on the cover side, held by a push button
- > Two lockable steel flip locks protect the case contents from theft
- > With circumferential double aluminium frame
- > Rugged design made of ABS material, black
- > Cover and tool boards made from dirt-repellent PP twin-wall sheets
- > Dimensions, exterior (W x H x D): 480 x 380 x 200 mm
- > Dimensions, interior (W x H x D): 460 x 310 x 190 mm



00 21 21 HK S

Article No.	EAN				Number	Nominal size	g
00 21 21 HK S	4003773-080671		Tool Case "Vision27" Plumbing, 52 parts		1		9600
			86 03 180 Pliers Wrench	KNIPEX	1	180 mm	
			87 01 250 KNIPEX Cobra®, Hightech Water Pump Pliers		1	250 mm	
			87 01 400 KNIPEX Cobra® XL, Hightech Water Pump Pliers		1	400 mm	
			74 06 180 High Leverage Diagonal Cutter		1	180 mm	
			26 16 200 Snipe Nose Side Cutting Pliers, (Stork Beak Pliers)		1	200 mm	
			00 11 01 KNIPEX TwinKey®, Control Cabinet Key		1		
			Screwdrivers for slotted screws, 160i	Wera	1	0.6 x 3.5 x 100 mm	
			Screwdrivers for slotted screws, 160i		1	1.0 x 5.5 x 125 mm	
			Screwdriver for Torx® screws, 167i		1	TX15 x 80 mm	
			Screwdriver for Torx® screws, 167i		1	TX20 x 80 mm	
			Screwdriver for Torx® screws, 167i		1	TX25 x 80 mm	
			Screwdrivers for cross recessed Phillips® screws, 162i PH		1	PH1 x 80 mm	
			Screwdrivers for cross recessed Phillips® screws, 162i PH		1	PH2 x 100 mm	
			Slotted chisel, 932 A		1	1.2 x 7.0 x 125 mm	
			Slotted chisel, 932 A		1	1.6 x 9.0 x 150 mm	
			Voltage detector, single-pole, 247		1	0.5 x 3.0 x 70 mm	
			Zyklop set of metal ratchets 8100 SA 8, 28 parts	1	1/4"		
			Joker open-end wrench	1	10 x 13 mm		
			Set of hex key wrenches	1	1.5 - 10 mm		
			Express key	Heyco	1	17 x 19 mm M 10	
			Safety cutter knife		1	18 mm	
			Locksmith's hammer	Picard	1	300 g	
			Mason's Chisels	Rennsteig	1	250 mm	
			Spirit level type 70	Stabila	1	30 cm	

KNIPEX L-BOXX®

Ideal storage and transport solution: the KNIPEX L-BOXX®

- ▶ Strong box made of impact- and shock-proof ABS plastic
- ▶ Max. payload: 25 kg
- > Splash-proof
- > Several boxes can be securely joined together
- > Flexible inner partitions
- > Handle can be lowered into a hollow in the lid to save space
- > Ergonomically shaped handles with additional moulded recess on the side for flexible, convenient handling
- > With two-piece tool board made from dirt-repellent PP twin-wall sheets
- > Tool holders are connected to each other using hook-and-loop
- > Cover part with ten pockets and ten elastic straps
- > Top of base part with seven pockets and tab for hanging up the tool card; can also be used to lift and set up the L-BOXX®
- > Bottom of base part with 7 pockets and 7 elastic straps
- > Dimensions, exterior (W x H x D): 442 x 442 x 151 mm
- > Dimensions, interior (W x H x D): 375 x 311 x 107 mm



00 21 19 LB LE
Case empty, without tool card



00 21 19 LB WK
Tool card, individually available

00 21 19 LB
Case empty, with tool card



The boxes are stackable and can be securely joined together



A lock can be attached to secure the device
(lock not included in delivery)



Washable tool boards

Article No.	EAN		g
00 21 19 LB	081616	KNIPEX L-BOXX®, empty, with tool card	3200
00 21 19 LB WK	081609	Two-part tool holder for KNIPEX L-BOXX®	953
00 21 19 LB LE	081975	KNIPEX L-BOXX®, empty, without tool card	2200

KNIPEX L-BOXX® Electric

**Ideal storage and transport solution:
the KNIPEX L-BOXX® with a large range
of tools for professional electricians**

► Equipped with 14 KNIPEX tools, a total of 63 brand tools,
partly VDE-tested according to DIN EN 60900

> For further benefits of the case,
see page 315



00 21 19 LB E

Content overview

00 11 01 KNIPEX		26 26 200 KNIPEX		97 53 04 KNIPEX		Wera	
08 26 145 KNIPEX		70 06 160 KNIPEX		98 52 KNIPEX		Picard	
12 42 195 KNIPEX		74 06 200 KNIPEX		2 x 98 2X XX KNIPEX		Rennsteig	
13 86 200 KNIPEX		86 03 180 KNIPEX		16 parts Wera		Stabila	
16 95 01 SB KNIPEX		87 01 180 KNIPEX		28 parts Wera		Stabila	

Article No.	EAN 4003773-				Number	Nominal size	g
00 21 19 LB E	081623		KNIPEX L-BOXX® Electric, 63 parts				7800
			00 11 01	KNIPEX TwinKey®, Control Cabinet Key	KNIPEX	1	
			08 26 145	Needle-Nose Combination Pliers		1	145 mm
			12 42 195	KNIPEX MultiStrip 10, Automatic Insulation Stripper		1	195 mm
			13 86 200	Pliers for Electrical Installation		1	200 mm
			16 95 01 SB	KNIPEX ErgoStrip®, Universal Stripping Tool		1	135 mm
			26 26 200	Snipe Nose Side Cutting Pliers (Stork Beak Pliers)		1	200 mm
			70 06 160	Diagonal Cutter		1	160 mm
			74 06 200	High Leverage Diagonal Cutter		1	200 mm
			86 03 180	Pliers Wrench		1	180 mm
			87 01 180	KNIPEX Cobra®, Hightech Water Pump Pliers		1	180 mm
			97 53 04	Self-Adjusting Crimping Pliers for wire end sleeves		1	180 mm
			98 52	Cable Knife		1	185 mm
			98 25 01 SL	Screwdrivers (Slim) for cross-recessed screws, Pozidriv®		1	PZ 1 x 80 mm
			98 20 35 SL	Screwdriver (Slim) for slotted screws		1	0,6 x 3,5 x 100 mm
				Kraftform Kompakt VDE 16 extra slim 1, 16 parts	Wera	1	
				Zyklus set of metal ratchets, 8100 SA 8, 28 parts	Wera	1	1/4"
				Joker open-end wrench	Wera	1	10 x 13 mm
				Locksmith's hammer	Picard	1	300 g
				Electrician's Chisel	Rennsteig	1	250 x 10 mm
				Spirit level type 70 Electric	Stabila	1	430 mm
				Pocket Electric mini spirit level		1	68 mm
00 21 19 LB	081616		KNIPEX L-BOXX®, empty, with tool card				3200
00 21 19 LB WK	081609		Two-part tool holder for KNIPEX L-BOXX®				953
00 21 19 LB LE	081975		KNIPEX L-BOXX®, empty, without tool card				2200

KNIPEX L-BOXX® Plumbing

Ideal storage and transport solution: the KNIPEX L-BOXX® with a large range of tools for the plumbing, heating and air-conditioning professional

▶ Equipped with 13 KNIPEX tools, a total of 52 brand tools, partly VDE-tested according to DIN EN 60900

> For further benefits of the case, see page 315



00 21 19 LB S

Content overview

00 11 01 KNIPEX		87 01 400 KNIPEX		9 parts Wera		Picard	
26 16 200 KNIPEX		7 x 98 2X XX KNIPEX		Heyco		Stabila	
74 06 180 KNIPEX		Wera		Heyco		Stabila	
86 03 250 KNIPEX		28 parts Wera		Rennsteig		Zenten	
87 01 250 KNIPEX		Wera		Rennsteig			

Article No.	EAN				Number	Nominal size	g
00 21 19 LB S	4003773-081630			KNIPEX L-BOXX® Plumbing, 52 parts			9400
			00 11 01	KNIPEX TwinKey®, Control Cabinet Key	1		
			26 16 200	Snipe Nose Side Cutting Pliers (Stork Beak Pliers)	1	200 mm	
			74 06 180	High Leverage Diagonal Cutter	1	180 mm	
			86 03 250	Pliers Wrench	1	250 mm	
			87 01 250	KNIPEX Cobra®, Hightech Water Pump Pliers	1	250 mm	
			87 01 400	KNIPEX Cobra® XL, Hightech Water Pump Pliers	1	400 mm	
			98 20 35	Screwdrivers for slotted screws	1	0.6 x 3.5 x 100 mm	
			98 20 55	Screwdrivers for slotted screws	1	1.0 x 5.5 x 125 mm	
			98 26 15	Screwdriver for Torx® screws	1	TX15 x 80 mm	
			98 26 20	Screwdriver for Torx® screws	1	TX20 x 80 mm	
			98 26 25	Screwdriver for Torx® screws	1	TX25 x 80 mm	
			98 24 01	Screwdrivers for cross-recessed screws, Phillips®	1	PH1 x 80 mm	
			98 24 02	Screwdrivers for cross-recessed screws, Phillips®	1	PH2 x 100 mm	
				Voltage detector, single-pole, 247	1	0.5 x 3.0 x 70 mm	
				Zyklop set of metal ratchets, 8100 SA 8, 28 parts	1	1/4"	
				Joker open-end wrench	1	10 x 13 mm	
				Set of hex key wrenches	1	1.5 - 10 mm	
				Express key	1	17 x 19 mm M 10	
				Safety cutter knife	1	18 mm	
				Electrician's Chisel	1	250 x 10 mm	
				Mason's Chisels	1	250 mm	
				Locksmith's hammer	1	300 g	
				Spirit level type 70	1	30 cm	
				Metre ruler (yardstick)	1	2 m	
				Pipe cutter	1	3 - 35 mm / 1/8 - 1 1/2"	
00 21 19 LB	081616			KNIPEX L-BOXX®, empty, with tool card			3200
00 21 19 LB WK	081609			Two-part tool holder for KNIPEX L-BOXX®			953
00 21 19 LB LE	081975			KNIPEX L-BOXX®, empty, without tool card			2200

Tool bag "Classic" Electric

Tried-and-tested: the handy tool bag with tool equipment

- ▶ Equipped with 23 brand tools, partly VDE-tested according to DIN EN 60900
- > Light design made of hard-wearing, reinforced polyester fabric
- > Front additionally reinforced with aluminium brackets
- > Semi-fold-out front with adjustable loops and exterior document compartment
- > With galvanized steel base tray
- > With carrying handle and adjustable shoulder strap
- > Dimensions, exterior (W x H x D): 440 x 270 x 180 mm
- Dimensions, interior (W x H x D): 420 x 250 x 160 mm



00 21 02 LE
Bag without tools

Article No.	EAN					Number	Nominal size	g
00 21 02 EL	4003773-081951				Tool bag "Classic" Electric, 23 parts			6700
		⚡ 1000V	🔧	🔗	03 06 180	1	180 mm	
		⚡ 1000V	🔧	🔗	11 06 160	1	160 mm	
		⚡ 1000V	🔧	🔗	26 16 200	1	200 mm	
		⚡ 1000V	🔧	🔗	70 06 160	1	160 mm	
		⚡ 1000V	🔧	🔗	98 52	1	185 mm	
		🔗	PATENTED		16 95 01 SB	1	135 mm	
		⚡ 1000V	🔧	⊖	98 20 25	1	0.4 x 2.5 x 75 mm	
					98 20 35 SL	1	0.6 x 3.5 x 100 mm	
		⚡ 1000V	🔧	⊖	98 20 55 SL	1	1.0 x 5.5 x 115 mm	
					98 20 65 SL	1	1.2 x 6.5 x 150 mm	
		⚡ 1000V	🔧	⊕	98 24 01 SL	1	PH1 x 80 mm	
					98 24 02 SL	1	PH2 x 100 mm	
		🔗			16 20 165	1	165 mm	
					Voltage detector, single-pole, 247	1	0.5 x 3.0 x 70 mm	
					Mason's Chisels	1	300 x 29 mm	
					Electrician's Chisel	1	250 x 10 mm	
					Locksmith's hammer	1	300 g	
					Chipping hammer	1	800 g	
					Metre ruler (yardstick)	1	2 m	
					Flat brush	1	40 mm	
					Plaster bowl	1	127 x 94 mm	
					PUK® Junior Hacksaw	1	150 x 240 mm	
					Painter's spatula, wood, high quality	1	40 mm	
00 21 02 LE	057499				Tool bag "Classic", empty			2970

Tool bag "Compact" Electric

► Equipped with 12 KNIPEX tools, partly VDE-tested according to DIN EN 60900

- > Compact tool bag for the service technician
- > Suitable as an insert for: "Basic" 00 21 05 LE, "BIG Basic Move" 00 21 06 LE, "BIG Twin Move" 00 21 41 LE, "BIG Twin" 00 21 42 LE, "BIG Twin Move RED" 98 99 15 LE and other popular tool cases
- > With 8 tool pouches and 7 tool straps
- > Slip-through back strap to attach to a trolley
- > Made from tough polyester fabric, with zip fastener
- > Bag without tools



00 21 11



00 21 11 LE
Bag without tools

Article No.	EAN				Quantity	△ g
00 21 11	4003773-084532			Tool Bag "Compact" Electric		2975
	026662	MM	12 40 200	Self-Adjusting Insulation Stripper	1	202
	035565	△ 1000 V	98 52	Cable Knife	1	67
	028017	MM (PATENTED)	97 53 04	Self-Adjusting Crimping Pliers for wire ferrules with lateral access	1	459
	022022	MM	87 01 250	KNIPEX Cobra® Hightech Water Pump Pliers	1	335
	079767	△ 1000 V ⊕	98 24 02 SL	Screwdriver (Slim) for cross-recessed screws Phillips®	1	94
	079774	△ 1000 V ⊕	98 25 01 SL	Screwdriver (Slim) for cross-recessed screws Pozidriv®	1	56
	079781	△ 1000 V ⊕	98 25 02 SL	Screwdriver (Slim) for cross-recessed screws Pozidriv®	1	90
	079712	△ 1000 V ⊖	98 20 35 SL	Screwdriver (Slim) for slotted screws	1	35
	075097	△ 1000 V ⊕ (PATENTED)	13 86 200	Pliers for Electrical Installation	1	280
	079927	MM (PATENTED)	16 95 01 SB	KNIPEX ErgoStrip® Universal Stripping Tool	1	75
	021995	△ 1000 V	70 06 160	Diagonal Cutter	1	216
	084099	△ 1000 V MM	78 06 125	Electronic Super Knips VDE	1	60
00 21 11 LE	077718			Tool Bag "Compact" empty		

Crimp Assortments

for non-insulated wire ferrules

- > In a TANOS MINI-systainer® (solid plastic box)
- > T-Loc fastener for one-handed operation: open or close the systainer® with one turn and connect to a second systainer®
- > Opening when connected: fast and simple access to content without disconnecting
- > Two stackable plastic inserts with 6 trays each for connectors
- > With an assortment of wire ferrules with/without collar

97 90 05

- > With Crimping Pliers for end sleeves 97 71 180; Wire end sleeves without collar

97 90 17

- > With crimping pliers for wire ferrules 97 53 09 and self-adjusting insulation stripper 12 42 195

97 90 23

- > With Crimping Pliers KNIPEX PreciForce for wire end sleeves 97 52 38

97 90 06

- > With Crimping Pliers for end sleeves 97 71 180; Wire end sleeves with collar

97 90 09

- > With Self-Adjusting Crimping Pliers for wire end sleeves 97 53 04

97 90 10

- > With Self-Adjusting Insulation Stripper 12 40 200; With Self-Adjusting Crimping Pliers for wire end sleeves 97 53 04

97 90 13

- > With KNIPEX Twistor®16 97 53 18 crimping pliers for wire ferrules

97 90 14

- > With crimping pliers for wire ferrules KNIPEX Twistor®16 97 53 18 and automatic insulation stripper KNIPEX PreciStrip16 12 52 195

97 90 15

- > With crimping pliers for wire ferrules 97 53 09 and automatic insulation stripper KNIPEX PreciStrip16 12 52 195

97 90 16

- > With crimping pliers for wire ferrules 97 53 09 and self-adjusting insulation stripper 12 40 200



97 90 05



97 90 10



97 90 13



97 90 23



Several boxes can be connected with each other

Article No.	EAN 4003773-		Pliers	200 x mm ²	150 x mm ²	100 x mm ²	75 x mm ²	50 x mm ²	40 x mm ²	Δ g	
97 90 05	025535		97 71 180	0,5 / 0,75 / 1 / 1,5 / 2,5	4 / 6			10 / 16		930	
97 90 06	025542		97 71 180	0,5 / 0,75 / 1 / 1,5	2,5		6	10	16	1000	
97 90 09	028574		97 53 04	0,5 / 0,75 / 1 / 1,5 / 2,5		4 / 6		10		1420	
97 90 10	046202		12 40 200 97 53 04	0,5 / 0,75 / 1 / 1,5 / 2,5		4 / 6		10		1353	
97 90 13	083474		97 53 18	0,5 / 0,75 / 1 / 1,5	2,5		6	10	16	1270	
97 90 14	084884		97 53 18 12 52 195	0,5 / 0,75 / 1 / 1,5	2,5		6	10	16	1450	
97 90 15	084877		97 53 09 12 52 195			1,5 / 2,5		6	4	1450	
97 90 16	086024		12 40 200 97 53 09	0,5 / 0,75 / 1 / 1,5 / 2,5		4 / 6		10		1450	
97 90 17	086031		97 53 09	0,5 / 0,75 / 1 / 1,5 / 2,5		4 / 6		10		1450	
97 90 23	062158		97 52 38	0,5 / 0,75 / 1 / 1,5 / 2,5		4 / 6				1226	
97 90 00 LE	054009	TANOS MINI-systainer® empty									900

Crimp Assortments

for cable connectors

- > In a TANOS MINI-systainer® (solid plastic box)
- > T-Loc fastener for one-handed operation: open or close the systainer® with one turn and connect to a second systainer®
- > Opening when connected: fast and simple access to content without disconnecting
- > Two stackable plastic inserts with 6 trays each for connectors
- > With an assortment of standard cable connectors

97 90 21

- > With Crimping Pliers KNIPEX PreciForce® 97 52 36 (for insulated terminals and plug connectors)

97 90 22

- > With Self-Adapting Universal Insulation Stripper KNIPEX Multi-strip 10, 12 42 195; with Crimping Pliers KNIPEX PreciForce® 97 52 36 (for insulated terminals and plug connectors)

97 90 25

- > With crimping pliers 97 22 240

97 90 26

- > With crimping pliers 97 32 240



97 90 21



97 90 22



97 90 25



97 90 26

Article No.	EAN 4003773-	Image	Pliers	Cable Connectors			g
					Quantity	Cable mm ²	
97 90 21	062134		97 52 36	Blade Terminal Sockets, 6.3 x 0.8 mm	25	0,5 - 1	1416
					25	1,5 - 2,5	
					25	0,5 - 1	
				Round Sockets, Ø 4 mm	25	0,5 - 1	
				Cable Connectors, eye type, Ø 4 mm	25	4 - 6	
					25	4 - 6	
				Cable Connectors, eye type, Ø 5 mm	25	1,5 - 2,5	
					25	1,5 - 2,5	
				Cable Connectors, eye type, Ø 6 mm	25	1,5 - 2,5	
				Butt Connectors, insulated, red	25	0,5 - 1	
				Butt Connectors, insulated, blue	25	4 - 6	
Round Pin Plugs, Ø 4 mm	25	1,5 - 2,5					
97 90 22	062141		97 52 36 12 42 195	Blade Terminal Sockets, 6.3 x 0.8 mm	25	0,5 - 1	1527
					25	1,5 - 2,5	
				Cable Connectors, eye type, Ø 4 mm	25	0,5 - 1	
				Cable Connectors, eye type, Ø 5 mm	25	0,5 - 1	
				Cable Connectors, eye type, Ø 6 mm	25	1,5 - 2,5	
				Cable Connectors, eye type, Ø 8 mm	25	1,5 - 2,5	
				Cable Connectors, eye type, Ø 4 mm	25	1,5 - 2,5	
				Cable Connectors, eye type, Ø 5 mm	25	4 - 6	
				Cable Connectors, eye type, Ø 6 mm	25	4 - 6	
				Butt Connectors, insulated, red	25	0,5 - 1	
				Butt Connectors, insulated, blue	25	1,5 - 2,5	
Butt Connectors, insulated, yellow	25	4 - 6					
97 90 25	076971		97 22 240	Blade Terminal Sockets, 6.3 x 0.8 mm	25	0,5 - 1,5	1150
					25	1 - 2,5	
				Cable Connectors, eye type, Ø 4 mm	25	0,5 - 1	
				Cable Connectors, eye type, Ø 5 mm	25	1,5 - 2,5	
				Cable Connectors, eye type, Ø 4 mm	25	4 - 6	
				Cable Connectors, eye type, Ø 5 mm	25	0,5 - 1	
				Cable Connectors, eye type, Ø 6 mm	25	1,5 - 2,5	
					25	0,5 - 1	
				Cable Connectors, eye type, Ø 8 mm	25	1,5 - 2,5	
				Butt Connectors, insulated, red	25	0,5 - 1	
				Butt Connectors, insulated, blue	25	1,5 - 2,5	
Butt Connectors, insulated, yellow	25	4 - 6					
97 90 26	079521		97 32 240	Non-insulated Blade Terminal Sockets 6.3 x 0.8 mm	25	1,5 - 2,5	1420
					25	4 - 6	
				Blade Terminal Sockets 6.3 x 0.8 mm	25	0,5 - 1	
					25	0,5 - 1	
				Blade Terminal Plugs 6.3 x 0.8 mm	25	1,5 - 2,5	
					25	4 - 6	
				Cable Connectors, eye type Ø 4 mm	25	4 - 6	
					25	0,5 - 1	
				Butt Connectors, insulated, red	25	1,5 - 2,5	
				Butt Connectors, insulated, blue	25	0,5 - 1	
				Butt Connectors, insulated, yellow	25	0,5 - 1	
97 90 00 LE	054009	TANOS MINI-systainer® empty					900

Tool Case for Photovoltaics

- > With tools for photovoltaics
- > Without crimping dies – please order separately (see ref. 97 49...) for individual assortment
- > With service tools (hexagonal key) for the change of crimping dies
- > Shock-resistant plastic case
- > Foam insert with recesses for tools, crimping dies and locators
- > Dimensions, exterior (W x H x D): 345 x 80 x 280 mm



97 91 01

Article No.	EAN			Quantity	g
97 91 01	4003773-070351		Tool Case for Photovoltaics		1964
		MM	12 12 11	Precision Insulation Stripper, with adapted blades	1
		⚠ 1000V ⚡ ⚙ ⚙ ⚙ ⚙	95 16 165	Cable Shears	1
		MM	97 43 200	Crimp System Pliers, for exchangeable crimping dies	1

Compact Tool Case

17 parts

- ▶ With insulated tools for works on electrical installations
- > Shock-resistant plastic case
- > Foam insert with precise recesses for holding the pliers
- > Equipped with a range of customary insulated KNIPEX tools for work on electrical systems
- > All tools are tested one by one and meet the requirements of ASTM F1505 and IEC 60900
- > Dimensions, exterior (W x H x D): 380 x 85 x 260 mm
- > DIN EN 60900, IEC 60900



98 99 11

Article No.	EAN 4003773- 026624				Quantity	g ⚖
98 99 11			Compact Tool Case 17 parts			3675
		⚡ 1000 V	03 07 200	Combination Pliers	1	
		⚡ 1000 V	70 07 160	Diagonal Cutter	1	
			98 20 35		1	
		⚡ 1000 V	98 20 40	Screwdrivers for slotted screws	1	
			98 20 55		1	
		⚡ 1000 V	98 24 00	Screwdriver for cross recessed screws, Phillips®	1	
		⚡ 1000 V	98 42	Reversible Ratchet, with driving square 1/2"	1	
		⚡ 1000 V	98 45 125	Extension Bar, with internal/external square 1/2"	1	
			98 45 250		1	
			98 47 10	Hexagon Socket for hexagonal screws, with internal square 1/2"	1	
			98 47 11		1	
			98 47 12		1	
		⚡ 1000 V	98 47 13		1	
			98 47 14		1	
			98 47 17		1	
			98 47 19	1		
		⚡ 1000 V	98 52	Cable Knife	1	

Compact Tool Case

26 parts

- ▶ With insulated tools for works on electrical installations
- > Shock-resistant plastic case
- > Foam insert with precise recesses for holding the pliers
- > Equipped with a range of customary insulated KNIPEX tools for work on electrical systems
- > Fixable partition wall
- > Dimensions, exterior (W x H x D): 440 x 105 x 385 mm



98 99 12

Article No.	EAN 4003773- 026631				Quantity	g ⚖
98 99 12				Standard Tool Case 26 parts		5533
		⚠ 1000V ⚡ ⚠ ⚠ ⚠ ⚠ ⚠ ⚠	03 07 200	Combination Pliers	1	
		⚠ 1000V ⚡ ⚠ ⚠ ⚠ ⚠ ⚠	70 07 160	Diagonal Cutter	1	
			98 00 10	Open End Wrench	1	
			98 00 11		1	
			98 00 12		1	
		⚠ 1000V ○	98 00 13		1	
			98 00 14		1	
			98 00 17		1	
			98 00 19	1		
		⚠ 1000V ⚡ ⚠ ⚠	98 53 03	Dismantling Knife for round cables	1	
			98 20 25	Screwdrivers for slotted screws	1	
		⚠ 1000V ⚡ ⚠ ⚠ ⚠	98 20 35		1	
			98 20 40		1	
			98 20 55		1	
			98 24 00	Screwdriver for cross recessed screws, Phillips®	1	
		⚠ 1000V ⚡ ⚠ ⚠ ⚠ ⚠	98 24 01		1	
			98 24 02	1		
		⚠ 1000V 1/2"	98 40	T-Handle Drive, with driving square 1/2"	1	
			98 47 10	Hexagon Socket for hexagonal screws, with internal square 1/2"	1	
			98 47 11		1	
			98 47 12		1	
		⚠ 1000V ○ ⚠	98 47 13		1	
			98 47 14		1	
			98 47 17		1	
			98 47 19	1		
		⚠ 1000V ⚡ ⚠ ⚠	98 52	Cable Knife	1	

Tool bag "Stretched"

Handy, but roomy: the tool bag for long tools

- > Made of hard-wearing polyester fabric
- > For tools up to 450 mm in length
- > With two compartments on the back
- > With carrying handle and adjustable shoulder strap
- > Closing strap made of leather
- > Bag without tools



00 21 07 LE

Article No.	EAN 4003773-	Dimension exterior (interior) width mm	Dimension exterior (interior) height mm	Dimension exterior (interior) depth mm	g
00 21 07 LE	071358	550 (530)	225 (190)	190 (160)	1760

Tool bag "LightPack"

Lightweight and durable, securely locked but quick to open: good for the service vehicle, good for the boot

- > Can be opened from both sides
- > Made from tough polyester fabric, with zip fasteners and hook-and-loop fastener
- > Tool loops inside
- > Plastic base tray
- > Steel handle with softgrip
- > Shoulder strap (can also be used as tool belt)
- > Max. payload: 20 kg
- > Bag without tools



00 21 08 LE



Article No.	EAN 4003773-	Dimension exterior (interior) width mm	Dimension exterior (interior) height mm	Dimension exterior (interior) depth mm	g
00 21 08 LE	077787	480 (450)	380 (310)	300 (260)	2800

Tool bag "Service"

Everything you need: store your tools and notebook safely

- > Lined inside pouch for notebook and DIN A4 documents; also with DIN A4 zipped compartment
- > 90° fold-out front pouch with 8 tool pouches and one small inside pouch
- > Reverse side of the front pouch with 5 tool pouches and 3 pen pouches
- > Removable tool board with 8 tool pouches on the front and 2 rows of elastic loops on the back
- > Splash-water-protected bottom
- > Adjustable shoulder belt with quick-release fastener
- > With two carry loops
- > Made of hard-wearing polyester fabric
- > Bag without tools



00 21 10 LE

Article No.	EAN 4003773-	Dimension exterior (interior) width mm	Dimension exterior (interior) height mm	Dimension exterior (interior) depth mm	⚖ g
00 21 10 LE	074472	460 (410)	310 (300)	240	2700

Tool bag "Compact"

Everything organised: tools well stored

▶ Compact tool bag for the service technician

- > Suitable as an insert for: "Basic" 00 21 05 LE, "BIG Basic Move" 00 21 06 LE, "BIG Twin Move" 00 21 41 LE, "BIG Twin" 00 21 42 LE, "BIG Twin Move RED" 98 99 15 LE and other popular tool cases
- > With 8 tool pouches and 7 tool straps
- > Slip-through back strap to attach to a trolley
- > Made from tough polyester fabric, with zip fastener
- > Bag without tools



00 21 11 LE

Article No.	EAN 4003773-	Dimension exterior (interior) width mm	Dimension exterior (interior) height mm	Dimension exterior (interior) depth mm	⚖ g
00 21 11 LE	077718	410 (380)	300 (280/280)	80 (65)	450

Tool Roll

empty

- > Tool roll made of hard-wearing polyester fabric
- > With practical, adjustable quick release fastener
- > Dimensions, open (L x H): 450 x 290 mm



Article No.	EAN	⚖️
00 19 41 LE	4003773-035930	g 155

Tool Roll

empty

- > Tool roll made of hard-wearing polyester fabric
- > With practical, adjustable quick release fastener
- > Dimensions, open (L x H): 830 x 310 mm



Article No.	EAN	⚖️
98 99 13 LE	4003773-028888	g 500

Belt Pouch

For two pliers: well stored and close at hand

- > For two pliers up to 160 mm in length
- > Made of hard-wearing polyester fabric
- > With hook-and-loop fastener
- > With elastic side holder for small flash lamp, pen or suchlike
- > With practical belt clip
- > Bag without tools



00 19 72 LE



Practical clip for attaching to belt or trousers



For better accessibility, the clip can be fixed on the inside with the hook-and-loop fastener

Article No.	EAN 4003773-	Width mm	Height mm	Depth mm	△ g
00 19 72 LE	070191	75	180	55	65



Belt Tool Pouch

The most important tools straight to you: The tool bag for your belt

- > Made of hard-wearing polyester fabric and leather
- > With pockets for up to 8 tools
- > Tool loops made of leather, riveted
- > With snap hook
- > Bag without tools

Article No.	EAN 4003773-	Width mm	Height mm	Depth mm	△ g
00 19 73 LE	072065	170	235	75	210



00 19 73 LE

INDEX ARTICLE NUMBER

00 11 01	147	00 20 18	286	02 02 200	5	12 12 12	23	16 29 165	34	29 11 160	47
00 11 02	147	00 20 18 ESD	260	02 02 225	5	12 12 13	23	16 30 135 SB	35	29 21 160	47
00 11 03	147	00 20 18 ESD	286	02 02 225 T	276	12 12 14	23	16 30 145 SB	35	29 25 160	47
00 11 04	148	00 20 72 V01	285	02 02 225 T	5	12 19 02	23	16 39 135	35	30 11 140	48
00 11 06	148	00 20 72 V02	285	02 05 180	5	12 19 06	23	16 40 150	36	30 11 160	48
00 11 06 V01	148	00 20 72 V04	285	02 05 200	5	12 19 10	23	16 49 150	36	30 11 190	48
00 11 06 V03	149	00 20 72 V04 XS	284	02 05 225	5	12 19 11	23	16 60 05 SB	36	30 13 140	48
00 11 07	149	00 20 72 V06	285	02 06 180	5	12 19 12	23	16 60 06 SB	37	30 13 160	48
00 11 V79	146	00 20 90 V01	289	02 06 180	202	12 19 13	23	16 60 100 SB	37	30 15 140	48
00 19 41	280	00 20 90 V02	289	02 06 200	5	12 19 14	23	16 64 125 SB	38	30 15 160	48
00 19 41 LE	280	00 21 02 EL	327	02 06 200	202	12 19 180	23	16 65 125 SB	38	30 15 190	48
00 19 41 LE	336	00 21 02 LE	327	02 06 225	5	12 21 180	23	16 80 125 SB	39	30 16 160	48
00 19 55 S4	281	00 21 05 LE	297	02 06 225	202	12 29 180	23	16 80 175 SB	39	30 16 160	211
00 19 55 S4	104	00 21 06	301	02 07 200	5	12 40 200	25	16 85 125 SB	39	30 21 140	48
00 19 55 S4 LE	281	00 21 06 HKS	303	02 07 200	202	12 42 195	24	16 90 130 SB	40	30 21 160	48
00 19 55 S5	113	00 21 06 HLS	300	02 07 225	5	12 49 01	25	16 95 01 SB	41	30 21 190	48
00 19 55 S5	281	00 21 06 LE	300	02 07 225	202	12 49 02	25	16 95 02 SB	41	30 23 140	48
00 19 55 S5 LE	113	00 21 06 LE	301	03 01 140	4	12 49 03	25	19 01 130	12	30 25 140	48
00 19 55 S5 LE	281	00 21 06 LE	299	03 01 160	4	12 49 04	24	19 03 130	12	30 25 160	48
00 19 55 S6	281	00 21 06 LE	302	03 01 180	4	12 49 04	25	20 01 125	44	30 25 190	48
00 19 55 S6 LE	281	00 21 06 LE	303	03 01 200	4	12 49 05	25	20 01 140	44	30 31 160	48
00 19 55 S7	281	00 21 06 M	302	03 01 250	4	12 49 21	27	20 01 160	44	30 33 160	48
00 19 55 S8	281	00 21 07 LE	334	03 02 160	4	12 49 21	24	20 01 180	44	30 35 140	48
00 19 55 S8 LE	281	00 21 08 LE	334	03 02 180	4	12 49 23	27	20 02 140	44	30 35 160	48
00 19 55 S9	281	00 21 10 LE	335	03 02 200	4	12 49 23	24	20 02 160	44	30 36 160	211
00 19 56	65	00 21 11	328	03 05 140	4	12 49 31	26	20 05 140	44	30 36 160	48
00 19 56	282	00 21 11 LE	335	03 05 160	4	12 52 195	26	20 05 160	44	31 11 160	47
00 19 56 LE	65	00 21 11 LE	328	03 05 180	4	12 52 195 SB	26	20 06 160	44	31 15 160	47
00 19 56 LE	282	00 21 15	240	03 05 200	4	12 59 01	25	20 06 160	209	31 21 160	47
00 19 56 V01	65	00 21 15	294	03 06 160	4	12 59 02	25	22 01 125	45	31 25 160	47
00 19 56 V01	282	00 21 15 LE	240	03 06 160	203	12 62 180	28	22 01 140	45	32 11 135	49
00 19 57	65	00 21 15 LE	294	03 06 180	4	12 64 180	29	22 01 160	45	32 21 135	49
00 19 57	282	00 21 15 LE	240	03 06 180	203	12 69 21	28	22 02 140	45	32 31 135	49
00 19 57 V01	65	00 21 15 LE	294	03 06 180 T	4	12 69 23	28	22 02 160	45	33 01 160	49
00 19 57 V01	282	00 21 19 LB E	325	03 06 180 T	203	12 69 31	29	22 05 140	45	33 03 160	49
00 19 58 LE	66	00 21 19 LB LE	324	03 06 180 T	276	12 72 190	27	22 05 160	45	34 12 130	256
00 19 58 LE	283	00 21 19 LB LE	326	03 06 200	4	12 74 180 SB	29	22 06 160	45	34 12 130 ESD	256
00 19 58 V01	66	00 21 19 LB LE	325	03 06 200	203	12 79 31	29	22 06 160	208	34 22 130	256
00 19 58 V01	283	00 21 19 LB S	326	03 07 160	4	12 80 040 SB	30	25 01 125	13	34 22 130 ESD	256
00 19 58 V02	66	00 21 19 LB WK	324	03 07 160	203	12 80 100 SB	30	25 01 140	13	34 32 130	256
00 19 58 V02	283	00 21 19 LB WK	325	03 07 180	4	12 82 130 SB	30	25 01 160	13	34 32 130 ESD	256
00 19 72 LE	337	00 21 19 LB WK	326	03 07 180	203	12 85 110 SB	31	25 02 140	13	34 42 130	256
00 19 72 LE	285	00 21 20	322	03 07 200	4	13 01 160	12	25 02 160	13	34 42 130 ESD	256
00 19 72 V01	285	00 21 20 LE	322	03 07 200	203	13 02 160	12	25 03 125	13	34 52 130	256
00 19 72 XS LE	284	00 21 21 HK S	323	03 07 250	4	13 05 160	12	25 05 140	13	34 52 130 ESD	256
00 19 73 LE	337	00 21 25	69	03 07 250	203	13 05 160 T	12	25 05 160	13	35 11 115	257
00 19 75 LE	158	00 21 25	295	08 05 110	7	13 05 160 T	276	25 06 160	13	35 12 115	257
00 19 92 V01 LE	261	00 21 35	314	08 21 145	6	13 42 165	32	25 06 160	209	35 12 115 ESD	258
00 19 92 V02 LE	261	00 21 35	315	08 22 145	6	13 45 165	32	25 06 160 T	13	35 21 115	257
00 20 01 V02	67	00 21 36	316	08 22 145 T	276	13 46 165	32	25 06 160 T	209	35 22 115	257
00 20 01 V02	287	00 21 36	317	08 22 145 T	6	13 46 165	207	25 06 160 T	276	35 22 115 ESD	258
00 20 01 V09	67	00 21 37	318	08 25 145	6	13 62 180	205	25 21 160	13	35 31 115	257
00 20 01 V09	287	00 21 37	319	08 26 145	6	13 62 180	33	25 25 160	13	35 32 115	257
00 20 01 V15	287	00 21 37 M	320	08 26 145	204	13 66 180	33	25 26 160	209	35 32 115 ESD	258
00 20 01 V16	287	00 21 37 M	321	08 26 145 T	6	13 66 180	205	25 26 160	13	35 41 115	257
00 20 01 V17	287	00 21 41	307	08 26 145 T	204	13 66 180 T	276	26 11 200	15	35 42 115	257
00 20 03 SB	68	00 21 41 LE	306	08 26 145 T	276	13 66 180 T	33	26 12 200	15	35 42 115 ESD	258
00 20 03 SB	288	00 21 41 LE	307	09 01 240	8	13 71 8	9	26 12 200 T	276	35 52 145	257
00 20 03 V02	68	00 21 42	309	09 02 240	8	13 72 8	9	26 12 200 T	15	35 62 145	257
00 20 03 V02	288	00 21 42 LE	308	09 02 240 T	276	13 81 200	11	26 13 200	15	35 82 145	257
00 20 04 SB	68	00 21 42 LE	309	09 02 240 T	8	13 82 200	11	26 15 200	15	36 12 130	259
00 20 04 SB	288	00 31 20 V01	293	09 11 240	8	13 82 200 T	276	26 15 200 T	15	36 22 125	259
00 20 04 V01	68	00 31 20 V02	293	09 12 240	8	13 82 200 T	11	26 15 200 T	276	36 32 125	259
00 20 04 V01	288	00 31 20 V03	293	09 12 240 T	8	13 86 200	11	26 16 200	15	37 11 125	50
00 20 09 V01	290	00 31 30 BK V01	289	09 12 240 T	276	13 86 200	208	26 16 200	210	37 13 125	50
00 20 09 V02	290	00 31 30 BK V02	289	10 98 I220	136	13 86 200	11	26 16 200 T	15	37 21 125	50
00 20 09 V03	290	00 31 30 BK V03	289	10 99 I220	136	13 92 200	11	26 16 200 T	210	37 23 125	50
00 20 10	290	00 50 01 T BK	276	11 01 160	18	13 96 200	208	26 16 200 T	276	37 31 125	50
00 20 11	291	00 50 02 T BK	276	11 02 160	18	13 96 200	11	26 17 200	15	37 33 125	50
00 20 11 V01	291	00 50 03 T BK	276	11 05 160	18	13 96 200 T	11	26 17 200	210	37 41 125	50
00 20 12	291	00 50 04 T BK	276	11 06 160	18	13 96 200 T	276	26 21 200	15	37 43 125	50
00 20 12 V01	292	00 50 05 T BK	276	11 06 160	204	13 96 200 T	208	26 22 200	15	38 11 200	51
00 20 12 V02	292	00 50 06 T BK	276	11 06 160 T	204	14 22 160	21	26 22 200 T	15	38 15 200	51
00 20 12 V03	292	00 21 19 LB	324	11 06 160 T	276	14 25 160	21	26 22 200 T	276	38 21 200	51
00 20 12 V04	293	00 21 19 LB	325	11 06 160 T	18	14 26 160	21	26 25 200	15	38 25 200	51
00 20 12 V05	293	00 21 19 LB	326	11 07 160	18	14 26 160	207	26 25 200 T	15	38 31 200	51
00 20 13	291	00 21 35 LE	315	11 07 160	204	15 11 120	31	26 25 200 T	276	38 35 200	51
00 20 15	240	00 21 36 LE	317	11 09 01	18	15 19 005	31	26 26 200	210	38 35 200 T	276
00 20 15	294	00 21 37 LE	319	11 09 01	204	15 19 006	31	26 26 200	15	38 35 200 T	51
00 20 16	260	00 21 37 LE	321	11 12 160	18	15 19 008	31	26 26 200 T	15	38 41 190	51
00 20 16	286	01 06 160	7	11 17 160	204	15 19 010	31	26 26 200 T	276	38 45 190	51
00 20 16 P	260	01 06 160	202	11 82 130	19	15 51 160	34	26 26 200 T	210	38 71 200	51
00 20 16 P	286	01 06 190	7	11 92 140	19	15 61 160	34	26 27 200	210	38 91 200	51
00 20 16 P ESD	260	01 06 190	202	12 11 180	23	15 81 160	34	26 27 200	15	38 95 200	51
00 20 16 P ESD	286	02 01 180	5	12 12 02	23	16 20 16 SB	34	28 01 200	46	40 04 180	52
00 20 17	260	02 01 200	5	12 12 06	23	16 20 165 SB	34	28 21 200	46	40 04 250	52
00 20 17	286	02 01 225	5	12 12 10	23	16 20 28 SB	34	28 71 280	46	40 14 250	52
00 20 18	260	02 02 180	5	12 12 11	23	16 20 50 SB	35	28 81 280	46	41 04 180	53

41 04 250	53	48 21 J11	58	70 05 160	83	74 02 200	87	79 22 120	248	87 01 560	112
41 04 300	53	48 21 J21	58	70 05 160 T	276	74 02 200 T	277	79 22 120 ESD	249	87 02 180	111
41 14 250	53	48 21 J31	58	70 05 160 T	83	74 02 200 T	87	79 22 125	248	87 02 180 T	277
41 24 225	53	48 21 J41	58	70 05 180	83	74 02 250	87	79 22 125 ESD	249	87 02 180 T	111
41 34 165	53	48 31 J0	59	70 05 180 T	83	74 02 250 T	87	79 32 125	248	87 02 250	111
41 44 200	53	48 31 J1	59	70 05 180 T	276	74 02 250 T	277	79 32 125 ESD	249	87 02 250 T	111
42 14 280	52	48 31 J2	59	70 06 125	83	74 05 140	87	79 42 125	248	87 02 250 T	277
42 24 280	52	48 31 J3	59	70 06 125	212	74 05 160	87	79 42 125 ESD	249	87 02 300	111
42 34 280	52	48 41 J01	59	70 06 140	212	74 05 180	87	79 42 125 Z	248	87 02 300 T	111
42 44 280	52	48 41 J11	59	70 06 140	83	74 05 200	87	79 42 125 Z ESD	249	87 02 300 T	277
44 10 J5	62	48 41 J21	59	70 06 160	83	74 05 250	87	79 52 125	248	87 03 125	111
44 10 J6	62	48 41 J31	59	70 06 160	212	74 06 160	87	79 52 125 ESD	249	87 03 180	111
44 11 J0	56	49 11 A0	60	70 06 160 T	212	74 06 160	213	79 62 125	248	87 03 250	111
44 11 J1	56	49 11 A1	60	70 06 160 T	276	74 06 180	213	79 62 125 ESD	249	87 03 300	111
44 11 J2	56	49 11 A2	60	70 06 160 T	83	74 06 180	87	81 01 250	121	87 05 250	111
44 11 J3	56	49 11 A3	60	70 06 180	82	74 06 200	87	81 03 250	121	87 05 300	111
44 11 J4	56	49 11 A4	60	70 06 180	83	74 06 200	213	81 11 250	121	87 09 125	111
44 13 J0	56	49 21 A01	60	70 06 180	212	74 06 200 T	87	81 13 250	121	87 09 150	111
44 13 J1	56	49 21 A11	60	70 06 180 T	276	74 06 200 T	277	81 19 250 V01	121	87 09 180	111
44 13 J2	56	49 21 A21	60	70 06 180 T	83	74 06 200 T	213	81 19 250 V02	121	87 09 180 V01	111
44 13 J3	56	49 21 A31	60	70 06 180 T	212	74 06 250	213	82 01 200	106	87 09 250 V01	111
44 13 J4	56	49 21 A41	60	70 07 160	212	74 06 250	87	82 01 200 SB	106	87 09 300 V01	111
44 19 J5	62	49 31 A0	61	70 07 160	83	74 06 250 T	213	82 02 200	106	87 09 400	112
44 19 J6	62	49 31 A1	61	70 07 180	82	74 06 250 T	277	82 02 200 SB	106	87 09 560	112
44 20 J51	62	49 31 A2	61	70 07 180	83	74 06 250 T	87	83 10 010	119	87 11 250	113
44 20 J61	62	49 31 A3	61	70 07 180	212	74 07 200	87	83 10 015	119	87 19 250	113
44 21 J01	56	49 41 A01	61	70 11 110	83	74 07 200	213	83 10 020	119	87 21 250	114
44 21 J11	56	49 41 A11	61	70 15 110	82	74 07 250	213	83 10 030	119	87 21 300	114
44 21 J21	56	49 41 A21	61	70 15 110	83	74 07 250	87	83 10 040	119	87 22 250	114
44 21 J31	56	49 41 A31	61	70 26 160	83	74 12 160	87	83 20 010	119	87 26 250	115
44 21 J41	56	50 00 160	72	70 26 160	212	74 12 180	87	83 20 015	119	87 26 250	215
44 23 J11	56	50 00 180	72	71 01 160	91	74 12 200	87	83 20 020	119	87 26 250 T	277
44 23 J21	56	50 00 210	72	71 01 200	92	74 21 250	87	83 30 005	120	87 26 250 T	115
44 23 J31	56	50 00 225	72	71 01 250	94	74 22 200	87	83 30 010	120	87 26 250 T	215
44 29 J51	62	50 00 250	72	71 02 200	92	74 22 200 T	277	83 30 015	120	87 29 01	114
44 29 J61	62	50 00 300	72	71 02 200 T	92	74 22 200 T	87	83 30 020	120	87 29 01	115
44 31 J02	56	50 01 160	72	71 02 200 T	277	74 22 250	87	83 30 030	120	87 29 01	215
44 31 J12	56	50 01 180	72	71 12 200	92	74 22 250 T	87	83 60 010	120	87 29 300	114
44 31 J22	56	50 01 210	72	71 21 200	93	74 22 250 T	277	83 60 015	120	87 41 250	108
44 31 J32	56	50 01 225	72	71 22 200	93	74 91 250	89	83 60 020	120	87 51 250	115
44 31 J42	56	50 01 250	72	71 22 200 T	93	75 02 125	250	83 61 010	120	88 01 180	117
45 10 170	64	50 01 300	72	71 22 200 T	277	75 12 125	250	83 61 015	120	88 01 250	117
45 21 200	64	51 01 210	72	71 31 160	91	75 22 125	250	83 61 020	120	88 01 300	117
46 10 100	63	55 00 300	73	71 31 200	93	75 52 125	250	84 11 200	142	88 01 400	118
46 10 A5	62	58 30 225	73	71 31 250	94	76 01 125	84	84 21 200	142	88 02 180	117
46 10 A6	62	61 01 200	97	71 32 200	93	76 03 125	84	85 01 250	108	88 02 250	117
46 11 A0	57	61 02 200	97	71 32 200 T	93	76 05 125	84	85 51 180 A	143	88 02 250 T	277
46 11 A1	57	62 12 120	255	71 32 200 T	277	76 12 125	84	85 51 180 A	143	88 02 250 T	117
46 11 A2	57	64 01 115	255	71 41 200	93	76 22 125	84	85 51 180 C	144	88 02 300	117
46 11 A3	57	64 02 115	255	71 72 460	95	76 81 125	84	85 51 180 C	144	88 02 300 T	277
46 11 A4	57	64 02 115 ESD	255	71 72 610	95	77 02 115 ESD	252	85 51 250 A	143	88 02 300 T	117
46 11 G0	64	64 11 115	255	71 72 760	95	77 02 120 H	253	85 51 250 AF	143	88 03 180	117
46 11 G1	64	64 12 115	255	71 72 910	95	77 02 120 H ESD	253	85 51 250 C	144	88 03 250	117
46 11 G2	64	64 12 115 ESD	255	71 79 460	95	77 02 135 H	253	85 59 250 A	143	88 03 300	117
46 11 G3	64	64 22 115	255	71 79 610	95	77 02 135 H ESD	253	85 59 250 C	144	88 05 180	117
46 11 G4	64	64 22 115 ESD	255	71 79 760	95	77 12 115 ESD	252	86 01 180	103	88 05 250	117
46 13 A0	57	64 32 120	255	71 79 910	95	77 22 115 ESD	252	86 01 250	103	88 05 300	117
46 13 A1	57	64 32 120 ESD	255	71 82 950	96	77 32 115 ESD	252	86 01 300	103	88 06 250	117
46 13 A2	57	64 42 115	255	71 89 950	96	77 32 120 H	253	86 02 180	103	88 06 250	214
46 13 A3	57	64 52 115	255	72 01 140	78	77 32 120 H ESD	253	86 02 250	103	88 07 250	117
46 19 100 01	63	64 62 120	255	72 01 160	78	77 42 115 ESD	252	86 03 125	103	88 07 250	214
46 19 100 02	63	64 62 120 ESD	255	72 01 180	78	77 52 115 ESD	252	86 03 150	103	88 07 300	117
46 19 A5	62	64 72 120	255	72 02 125	78	77 72 115 ESD	252	86 03 180	103	88 07 300	214
46 19 A6	62	67 01 140	98	72 09 01	78	78 03 125	245	86 03 250	103	90 10 165 BK	137
46 20 A51	62	67 01 160	98	72 11 160	78	78 03 125 ESD	245	86 03 300	103	90 10 165 E01	137
46 20 A61	62	67 01 200	98	72 21 160	78	78 03 140	246	86 03 400	104	90 10 185	124
46 21 A01	57	67 05 140	98	72 51 160	79	78 03 140 ESD	247	86 04 100	103	90 20 185	124
46 21 A11	57	67 05 160	98	72 62 200	79	78 06 125	245	86 05 150	103	90 22 01 SB	125
46 21 A21	57	67 05 200	98	73 02 160	85	78 13 125	245	86 05 150 S02	105	90 22 02 SB	125
46 21 A31	57	68 01 160	73	73 05 160	85	78 13 125 ESD	245	86 05 180	103	90 22 10 BK	126
46 21 A41	57	68 01 160	98	73 05 160 T	277	78 23 125	245	86 05 180 T	277	90 22 10 E01	126
46 23 A01	57	68 01 180	98	73 05 160 T	85	78 31 125	245	86 05 180 T	103	90 23 01 BK	127
46 23 A11	57	68 01 180	73	73 06 160	85	78 41 125	245	86 05 250	103	90 23 01 E01	127
46 23 A21	57	68 01 200	73	73 06 160	213	78 61 125	245	86 05 250 T	277	90 23 01 E02	127
46 23 A31	57	68 01 200	98	73 06 160 T	213	78 61 125 ESD	245	86 05 250 T	103	90 25 185	129
46 29 A51	62	68 01 280	73	73 06 160 T	277	78 61 140	246	86 06 250	103	90 25 20	128
46 29 A61	62	68 01 280	98	73 06 160 T	85	78 61 140 ESD	247	86 06 250	214	90 25 25	130
46 31 A02	57	70 01 110	83	73 71 180	88	78 71 125	245	86 09 180 V01	105	90 25 25 E01	130
46 31 A12	57	70 01 125	83	73 72 180	88	78 71 125 ESD	245	86 09 250 V01	105	90 25 40	128
46 31 A22	57	70 01 140	83	73 72 180 F	88	78 81 125	245	86 09 300 V01	105	90 29 01	124
46 31 A32	57	70 01 160	83	74 01 140	87	78 91 125	245	87 00 100	109	90 29 01	128
46 31 A42	57	70 01 180	83	74 01 160	87	79 02 120	248	87 00 100	111	90 29 01	129
48 11 J0	58	70 02 125	83	74 01 180	87	79 02 120 ESD	249	87 01 125	111	90 29 02	128
48 11 J1	58	70 02 140	83	74 01 200	87	79 02 125	248	87 01 150	111	90 29 15	128
48 11 J2	58	70 02 160	83	74 01 250	87	79 02 125 ESD	249	87 01 180	111	90 29 185	124
48 11 J3	58	70 02 180	83	74 02 140	87	79 02 125 S1	248	87 01 250	111	90 29 40	128
48 11 J4	58	70 05 125	83	74 02 160	87	79 12 125	248	87 01 300	111	90 31 02 BK	131
48 21 J01	58	70 05 140	83	74 02 180	87	79 12 125 ESD	249	87 01 400	112	90 31 02 SB	131

INDEX ARTICLE NUMBER

90 31 03 BK	132	92 64 43	265	95 36 280	219	97 49 63	175	97 90 15	190	97 99 371	195
90 31 03 E01	132	92 67 63	216	95 36 315 A	162	97 49 64	175	97 90 15	329	97 99 372	195
90 39 02 V01	131	92 67 63	271	95 36 315 A	220	97 49 65	175	97 90 16	190	97 99 373	195
90 39 02 V01	132	92 69 84	271	95 36 320	161	97 49 66	175	97 90 16	329	97 99 374	195
90 39 02 V02	131	92 72 45	265	95 36 320	220	97 49 66 2	177	97 90 17	190	97 99 375	195
90 39 02 V03	131	92 78 77 ESD	266	95 39 038	163	97 49 66 4	175	97 90 17	329	97 99 376	195
90 39 02 V03	132	92 81 01	263	95 39 04	160	97 49 66 6	175	97 90 21	330	97 99 377	195
90 42 250	141	92 81 02	263	95 39 04	219	97 49 67	175	97 90 22	330	97 99 378	195
90 42 340	141	92 81 03	263	95 39 08	160	97 49 68	175	97 90 23	190	97 99 390	195
90 49 340	141	92 81 04	263	95 39 08 S	160	97 49 69 1	175	97 90 23	329	97 99 391	195
90 49 340 M	141	92 81 05	263	95 39 08 S	219	97 49 69 2	175	97 90 25	330	97 99 392	195
90 55 280	141	92 84 18	265	95 39 250	160	97 49 70	175	97 90 26	330	97 99 393	195
90 59 280	141	92 89 01	263	95 39 250	219	97 49 71	175	97 91 01	176	97 99 394	195
90 61 16	142	92 89 02	263	95 39 280	160	97 49 72	175	97 91 01	331	97 99 395	195
90 61 20	142	92 89 03	263	95 39 280	219	97 49 74	175	97 99 001	192	97 99 396	195
90 70 220	145	92 89 04	263	95 39 315 A01	162	97 49 76	175	97 99 010	192	97 99 397	195
91 00 200	145	92 89 05	263	95 39 315 A01	220	97 49 81	175	97 99 011	192	97 99 398	195
91 13 250	146	92 91 01	269	95 39 320 01	161	97 49 82	175	97 99 020	192	97 99 399	195
91 19 250 01	146	92 91 02	269	95 39 320 01	220	97 49 83	175	97 99 021	192	97 99 500	197
91 92 180	145	92 91 03	269	95 39 320 02	161	97 49 84	175	97 99 022	192	97 99 905	196
92 00 01 ESD	261	92 94 91	270	95 39 320 02	220	97 49 87	175	97 99 030	192	97 99 906	196
92 00 02	261	92 95 89	270	95 39 340 01	159	97 50 01	177	97 99 050	192	97 99 907	196
92 00 03	261	92 95 90	270	95 39 720	163	97 51 10	178	97 99 060	192	97 99 908	196
92 00 04	261	94 10 185	133	95 39 870	163	97 51 12	178	97 99 070	192	97 99 909	196
92 00 05 ESD	261	94 15 215	138	95 41 165	154	97 52 04	180	97 99 071	192	97 99 910	196
92 01 01	267	94 19 02	133	95 61 150	164	97 52 05	180	97 99 090	192	97 99 911	196
92 01 02	267	94 19 02	138	95 61 190	164	97 52 06	180	97 99 091	192	98 01 07	224
92 01 03	267	94 19 185	133	95 62 160	156	97 52 08	180	97 99 092	192	98 01 08	224
92 01 04	267	94 19 215	138	95 62 160 TC	156	97 52 09	180	97 99 110	192	98 01 09	224
92 01 05	265	94 19 215	139	95 62 190	164	97 52 10	180	97 99 111	192	98 01 10	224
92 01 06	265	94 35 215	139	95 62 190 T	277	97 52 13	180	97 99 112	192	98 01 11	224
92 01 07	268	94 55 200	138	95 62 190 T	164	97 52 14	179	97 99 130	192	98 01 12	224
92 02 54	267	94 59 200 01	138	95 71 445	165	97 52 18	180	97 99 131	192	98 01 13	224
92 08 78 ESD	267	95 02 21	139	95 71 600	165	97 52 19	180	97 99 150	193	98 01 14	224
92 08 79 ESD	268	95 03 160 SB	140	95 77 600	165	97 52 20	179	97 99 151	193	98 01 15	224
92 09 01 ESD	270	95 05 10 SB	157	95 77 600	221	97 52 23	180	97 99 170	193	98 01 16	224
92 09 02 ESD	270	95 05 140	140	95 79 445	165	97 52 30	181	97 99 171	193	98 01 17	224
92 09 03 ESD	270	95 05 155 SB	157	95 79 600	165	97 52 33	181	97 99 172	193	98 01 18	224
92 09 04 ESD	270	95 05 165	157	95 79 600	221	97 52 34	181	97 99 173	193	98 01 19	224
92 09 05 ESD	270	95 05 185	140	95 81 600	165	97 52 35	181	97 99 174	193	98 01 22	224
92 11 01	264	95 05 190	140	95 89 600	165	97 52 36	181	97 99 175	193	98 01 24	224
92 11 01 ESD	264	95 05 20 SB	158	97 21 215	168	97 52 37	181	97 99 176	193	98 03 04	225
92 11 02	268	95 06 230	157	97 21 215 B	168	97 52 38	181	97 99 177	193	98 03 05	225
92 11 03	268	95 06 230	216	97 21 215 C	168	97 52 50	181	97 99 178	193	98 03 055	225
92 16 01 ESD	268	95 11 160	153	97 22 240	168	97 52 63	183	97 99 179	193	98 03 06	225
92 16 02 ESD	268	95 11 160 SB	153	97 32 240	168	97 52 63 DG	183	97 99 180	193	98 03 07	225
92 21 01	262	95 11 165	154	97 33 01	171	97 52 64	183	97 99 210	193	98 03 08	225
92 21 01 ESD	266	95 11 200	155	97 33 02	171	97 52 65	183	97 99 211	193	98 03 09	225
92 21 02	262	95 12 160	153	97 40 10	169	97 52 65 A	183	97 99 212	193	98 03 10	225
92 21 02 ESD	266	95 12 160 SB	153	97 40 20 SB	177	97 52 65 DG	183	97 99 213	193	98 03 11	225
92 21 03	262	95 12 165	154	97 43 05	172	97 52 65 DG A	183	97 99 214	193	98 03 12	225
92 21 03 ESD	266	95 12 165 T	277	97 43 06	172	97 53 04	184	97 99 215	193	98 03 13	225
92 21 04	262	95 12 165 T	154	97 43 200	172	97 53 08	187	97 99 216	193	98 04 08	225
92 21 05	262	95 12 200	155	97 43 200 A	172	97 53 09	187	97 99 217	193	98 04 10	225
92 21 06	262	95 12 500	158	97 43 E	173	97 53 18	186	97 99 218	193	98 04 13	225
92 21 07	265	95 16 160	153	97 43 E AUS	173	97 54 24	188	97 99 219	193	98 04 17	225
92 21 08	265	95 16 160 SB	153	97 43 E UK	173	97 54 25	188	97 99 220	193	98 04 19	225
92 22 04	265	95 16 165	154	97 43 E US	173	97 54 26	188	97 99 250	193	98 04 22	225
92 22 06	265	95 16 165	217	97 49 04	174	97 54 27	188	97 99 251	193	98 05 13	225
92 22 07	265	95 16 165 T	217	97 49 05	174	97 55 04	184	97 99 252	193	98 05 17	225
92 22 12	265	95 16 165 T	277	97 49 06	174	97 55 14	184	97 99 270	194	98 05 19	225
92 22 13	265	95 16 165 T	154	97 49 07	174	97 61 145 A	188	97 99 271	194	98 07 250	224
92 22 35	265	95 16 200	155	97 49 08	174	97 62 145 A	188	97 99 272	194	98 13 20	226
92 23 01	269	95 17 200	155	97 49 09	174	97 68 145 A	222	97 99 290	194	98 13 25	226
92 23 05	269	95 17 200	155	97 49 10	174	97 68 145 A	188	97 99 291	194	98 13 30	226
92 27 61	216	95 17 200	217	97 49 11	174	97 71 180	189	97 99 292	194	98 13 40	226
92 27 61	271	95 17 500	158	97 49 14	174	97 72 180	189	97 99 293	194	98 13 50	226
92 27 62	216	95 17 500	218	97 49 15	174	97 78 180	189	97 99 330	194	98 13 60	226
92 27 62	271	95 21 165	154	97 49 16	174	97 78 180	222	97 99 331	194	98 14 05	226
92 28 69 ESD	266	95 21 600	159	97 49 18	174	97 78 180 T	277	97 99 332	194	98 14 06	226
92 28 70 ESD	266	95 22 165	154	97 49 19	174	97 78 180 T	222	97 99 333	194	98 14 08	226
92 28 71 ESD	266	95 26 165	154	97 49 20	174	97 78 180 T	189	97 99 334	194	98 15 05	226
92 28 72 ESD	266	95 26 165	217	97 49 23	174	97 81 180	189	97 99 335	194	98 15 06	226
92 31 01	262	95 27 600	159	97 49 24	174	97 90 00 LE	330	97 99 336	194	98 15 08	226
92 32 29	265	95 27 600	218	97 49 25	174	97 90 00 LE	190	97 99 337	194	98 20 10	227
92 34 36	265	95 29 600	159	97 49 26	174	97 90 00 LE	329	97 99 338	194	98 20 25	227
92 34 37	265	95 29 600	218	97 49 27	174	97 90 05	190	97 99 339	194	98 20 30	227
92 37 64	216	95 31 250	160	97 49 28	174	97 90 05	329	97 99 350	194	98 20 35	227
92 37 64	271	95 31 280	160	97 49 30	174	97 90 06	190	97 99 351	194	98 20 35 SL	227
92 38 75 ESD	266	95 32 038	163	97 49 35	174	97 90 06	329	97 99 352	194	98 20 40	227
92 47 01	216	95 32 060	163	97 49 40	174	97 90 09	190	97 99 353	194	98 20 40 SL	227
92 47 01	271	95 32 100	163	97 49 44	175	97 90 09	329	97 99 354	194	98 20 55	227
92 51 01	262	95 32 315 A	162	97 49 50	175	97 90 10	190	97 99 355	194	98 20 55 SL	227
92 51 02	262	95 32 320	161	97 49 54	175	97 90 10	329	97 99 356	194	98 20 65	227
92 52 23	265	95 32 340 SR	159	97 49 59	175	97 90 13	190	97 99 357	194	98 20 65 SL	227
92 58 74 ESD	266	95 36 250	160	97 49 60	175	97 90 13	329	97 99 358	194	98 20 80	227
92 61 01	265	95 36 250	219	97 49 61	175	97 90 14	190	97 99 359	194	98 21 45	227
92 61 02	265	95 36 280	160	97 49 62	175	97 90 14	329	97 99 370	195	98 24 00	227

98 24 01	227	98 65 40	236
98 24 01 SL	228	98 65 41	236
98 24 01 SLS	228	98 65 42	236
98 24 02	227	98 65 43	236
98 24 02 SL	228	98 65 44	236
98 24 02 SLS	228	98 65 45	236
98 24 03	227	98 65 46	236
98 24 04	227	98 65 47	236
98 25 00	228	98 65 48	236
98 25 01	228	98 65 49	236
98 25 01 SL	229	98 65 50	236
98 25 02	228	98 65 51	236
98 25 02 SL	229	98 66 01	236
98 25 03	228	98 66 02	236
98 25 04	228	98 66 03	236
98 26 10	229	98 66 10	236
98 26 15	229	98 66 20	236
98 26 20	229	98 66 30	236
98 26 25	229	98 66 40	236
98 26 30	229	98 66 45	236
98 29 25	230	98 66 50	236
98 29 27	230	98 66 60	236
98 29 30	230	98 67 05	237
98 29 40	230	98 67 10	237
98 29 45	230	98 67 15	237
98 29 50	230	98 67 20	237
98 30	230	98 67 25	237
98 31	230	98 90	237
98 33 25	233	98 90 01	237
98 33 50	233	98 99 11	238
98 35 125	231	98 99 11	332
98 35 250	231	98 99 12	239
98 37 1/2"	232	98 99 12	333
98 37 10	231	98 99 13	241
98 37 11	231	98 99 13	280
98 37 12	231	98 99 13 LE	241
98 37 13	231	98 99 13 LE	280
98 37 14	231	98 99 13 LE	336
98 37 16	231	98 99 15	310
98 37 17	231	98 99 15	311
98 37 19	231	98 99 15 LE	310
98 37 3/4"	232	98 99 15 LE	311
98 37 3/8"	232	99 00 200	74
98 37 5/16"	232	99 00 220	74
98 37 5/8"	232	99 00 220 K12	74
98 37 7/16"	232	99 00 250	74
98 37 9/16"	232	99 00 280	74
98 39 05	232	99 00 300	74
98 39 06	232	99 01 200	74
98 39 08	232	99 01 220	74
98 40	230	99 01 250	74
98 41	230	99 01 280	74
98 42	233	99 01 300	74
98 43 50	233	99 04 220	74
98 45 125	231	99 04 250	74
98 45 250	231	99 04 280	74
98 47 1"	232	99 10 250	75
98 47 1/2"	232	99 10 300	75
98 47 10	231	99 11 250	75
98 47 11	231	99 11 300	75
98 47 11/16"	232	99 14 250	75
98 47 12	231	99 14 300	75
98 47 13	231		
98 47 14	231		
98 47 16	231		
98 47 17	231		
98 47 18	231		
98 47 19	231		
98 47 22	231		
98 47 24	231		
98 47 27	231		
98 47 3/4"	232		
98 47 5/8"	232		
98 47 7/8"	232		
98 47 9/16"	232		
98 49 05	232		
98 49 06	232		
98 49 08	232		
98 52	234		
98 53 03	234		
98 53 13	234		
98 54	234		
98 55	234		
98 56	235		
98 56 09	235		
98 62 01	235		
98 62 02	235		
98 64 02	236		

12-Point Sockets	232	Diagonal Cutters	82, 212
ACSR Cable Cutter (ratchet action)	159	Diagonal Cutters for plastics	78
Adjustable Wrench	224	Diagonal Insulation Strippers	21, 207
Alligator® – Water Pump Pliers	116, 214	DP50 – Pipe Cutter for plastic drain pipes	127
Alligator® XL – Water Pump Pliers	118	Duckbill Pliers	49
Angled Electricians' Shears	158	Ear Clamp Pliers	136
Anvil Shears	138	eCrimp	173
Assortment Boxes	196	Electricians' Gloves	236
Automatic Crimping Pliers for Wire Ferrules	185	Electricians' Pliers	12
Automatic Insulation Stripper	24, 28	Electricians' Shears	157
Automatic Insulation Stripper for flat cable	29	Electronic Super Knips	244
Automatic Stripping Pliers	29	Electronic Super Knips XL / ESD	246, 247
Belt Pouch	337	Electronics Diagonal Cutters / ESD	250–253
BiX – Cutter for plastic pipes and sealing sleeves	126	Electronics End Cutting Nippers	254
Bolt Cutters	95	Electronics Mounting Pliers	259
Bolt End Cutting Nippers	97	Electronics Oblique Cutting Nipper	255
Bowden Cable Cutter	164	Electronics Pliers	257
Box Wrenches	224	Electronics Pliers ESD	258
Brick Pincers	73	Electronics Pliers Sets	260
Cable Connectors	192–195	Electronics Wire Stripper	19
Cable Cutters (ratchet action)	160, 162, 163, 219, 220	Electronics Wire Stripping Shears	19
Cable Cutters (ratchet principle, 3-stage)	161, 220	End Cutting Nippers	73, 98
Cable Knives	234, 235	ErgoStrip® – Universal Stripping Tool	41
Cable Shears	154, 157–159, 216–218	Extension Bars	231
Cable Shears (ratchet action)	163	Extension sets Electric	289
Cable Shears with twin cutting edge	155, 217	Farriers' Pincers	73
Carpenters' Pincers	72	F-compression connector	197
Case for Electronics Pliers	286	Flat Nose Pliers	44, 209
Circlip Pliers for external circlips on shafts	57	Flat Pin Accessory Distributors	192
Circlip Pliers for grip rings on shafts	64	Folding Knife for Electricians	35
Circlip Pliers for internal circlips in bore holes	56	Four-Mandrel Crimping Pliers for turned contacts	182
Circlip Pliers for large external circlips	62	Grip Pliers	53
Circlip Pliers for large internal circlips	62	Gripping Pliers	47
Circlip Tool	63	Gripping Pliers for precision mechanics	50
CoBolt – Compact Bolt Cutters	92	Hammerhead Style Carpenters' Pincers	72
CoBolt S – Compact Bolt Cutters	91	Hexagon Sockets for hexagonal socket screws	231, 232
CoBolt XL – Compact Bolt Cutters	94	High Leverage Centre Cutters	89
Cobra® – Hightech Water Pump Pliers	110	High Leverage Combination Pliers	5, 202
Cobra® ES – Water Pump Pliers	115	High Leverage Concreters' Nippers	75
Cobra® QuickSet – Hightech Water Pump Pliers	114	High Leverage Diagonal Cutters	86, 213
Cobra® Set	113, 281	High Leverage End Cutting Nippers	98
Cobra® VDE – Hightech Water Pump Pliers	115, 215	High Leverage Flush Cutter for soft metal and plastic	79
Cobra® XL / XXL – Hightech Water Pump Pliers	112	High Performance Diagonal Cutters	88
Cobra® XS – Hightech Water Pump Pliers	109	Hose Clamp Pliers for Click clamps	144
Cobra®...matic – Water Pump Pliers	113	Insertion tool	169
Combination Pliers	4, 7, 202, 203	Insulating clamps	236
Combination Shears	140	Insulating Mats	237
Compact Bolt Cutters	91, 92, 94	Insulation Strippers	18, 23, 33, 34, 204, 205
Compact Diagonal Cutters	213	Jewellers' Pliers	12
Compact Diagonal Cutters high lever transmission	85	L-BOXX®	324
Compact Tool Case	238, 239, 332, 333	L-BOXX® Electric	325
Compression Tool for coax connectors	177	L-BOXX® Plumbing	326
Concrete Mesh Cutter	96	Lineman's Pliers, American style	8
Concreters' Nippers	74	Long Nose Pliers	48, 211
Control Cabinet Keys	147, 149	Long Reach Needle-Nose Pliers	46
Corrugated pipe cutters	125	Material catcher	146
Crimp Assortments	190, 191, 329, 330	Mechanics' Pliers	51
Crimp System Pliers	172	Mini Combination Pliers	7
Crimping Dies	174	Mini Pliers Sets	284, 285
Crimping Pliers	168	Mini Precision Tweezers	262
Crimping Pliers also for two-hand operation	180	Mini Wire Stripper	30
Crimping Pliers for micro plugs	188	Mitre Shears for plastic and rubber sections	139
Crimping Pliers for RJ45 Western plugs	179	MultiCrimp – Crimping Pliers with changer magazine	170
Crimping Pliers for Scotchlok™ connectors	177	Multifunction Electrician Pliers, American style	9
Crimping Pliers for Western plugs	178	Multiple Slip Joint Spanner	108
Crimping Pliers for wire ferrules	188, 189, 222	MultiStrip 10 – Automatic Insulation Stripper	24
Crimping Pliers with changer magazine	170	Multi-Tool for Electricians	27
Crimping Pliers, short design	179	Needle-Nose Combination Pliers	6, 204
CutiX – Universal knife	137	Needle-Nose Pliers	47
Cutter for flexible hoses and plastic conduit pipes	124	NexStrip® – Multi-Tool for Electricians	27
Cutter for plastic pipes and sealing sleeves	126	Notching Pliers	142
Cutter for ribbon cable	138	Nut Drivers	225
Cutting Tweezers	264	Open-end wrenches	223
Cycle Pliers	142	Parrot Beak Pincer	145
Depth Stripping Tool	39	Pen-Style Control Cabinet Key	149
Diagonal Cutter for electromechanics	84	Pipe Cutter for composite and plastic pipes	128, 130
Diagonal Cutter for fibre optics	79	Pipe Cutter for composite pipes and protective tubes	128

Pipe Cutter for plastic composite pipes	129	Tool bag "Compact"	335
Pipe Cutter for plastic conduit pipes	133	Tool bag "Compact" Electric	328
Pipe Cutter for plastic drain pipes	127	Tool bag "LightPack"	334
Pipe Cutters for multilayer and pneumatic hoses	124	Tool bag "Service"	335
Pipe Wrenches	119, 120	Tool bag "Stretched"	334
Plastic Flat Nose Pliers	235	Tool Box "RED" Electro Set 1	240
Plastic Slip-On Caps	236	Tool Box "RED" Electro Set 2	240
Plastic Snipe Nose Pliers	235	Tool Box "SRZ" Precision Circlip Pliers	69, 295
Plastic Tweezers / ESD	270, 271	Tool Box "RED" Electric Set 1	294
PlastiCut® – Cutter for flexible hoses and plastic conduit pipes	124	Tool Box "RED" Electric Set 2	294
Pliers for Electrical Installation	10, 208	Tool Case "Basic"	297
Pliers Sets	67, 293	Tool Case "BIG Basic Move"	299
Pliers Sets in a foam tray	287	Tool Case "BIG Basic Move" Electric	300
Pliers Wrench Set	281	Tool Case "BIG Basic Move" ElectricPlus	301
Pliers Wrench XL	104	Tool Case "BIG Basic Move" Mechanics	302
Pliers Wrenches	102, 105, 214	Tool Case "BIG Basic Move" Plumbing	303
Positioning Tweezers / ESD	268	Tool Case "Big Twin Move Red" Electric Competence	310
Potters' Pincers	73	Tool Case "Big Twin Move"	306
PreciForce – Crimping Pliers	181	Tool Case "Big Twin Move" Electric	307
Precision Circlip Pliers for external circlips on shafts	60	Tool Case "Big Twin" Electric	309
Precision Circlip Pliers for internal circlips in bore holes	58	Tool Case "Big Twin"	308
Precision Circlip Pliers Set	68, 288	Tool Case "Robust"	313
Precision Cross Jaw Tweezers	269	Tool Case "Robust23" Electric	314
Precision Electronics Diagonal Cutters / ESD	248, 249	Tool Case "Robust34" Electric	316
Precision Electronics Gripping Pliers	256	Tool Case "Robust45 Move" Electric	318
Precision Insulation Strippers	22	Tool Case "Robust45 Move" Mechanics	320
Precision Tweezers	262	Tool Case "Vision24" Electric	322
PreciStrip16 – Automatic Insulation Stripper	26	Tool Case "Vision27" Plumbing	323
Profi-Key	148	Tool Case for Photovoltaics	176, 331
Protective jaws	105, 111	Tool Kits	290, 292
PUK® Junior Hacksaw	237	Tool Roll	336, 241, 280
Punch Lock Riveters	141	Tool Sets in a blister	289
Radio Pliers	13, 209	Torque Wrenches	233
Relay Adjusting Pliers	49	Tower Pincers	74
Reversible Ratchets	230, 233	TubiX – Pipe Cutter	131
Revolving Punch Pliers	145	TubiX XL – Pipe Cutter	132
Round Nose Pliers	45, 208	Tweezer Sets	261
Round Pliers with cutting edge	12	Tweezers with exchangeable tips ESD	263
Screwdriver	226–229	TwinForce – High Performance Diagonal Cutters	88
Self-Adjusting Crimping Pliers for wire ferrules	184, 187	TwinGrip – Slip Joint Pliers	106
Self-Adjusting Insulation Strippers	25	TwinKey® – Control Cabinet Key	147
Self-Clamping Slip-On Caps	236	TwistCut® – Corrugated pipe cutters	125
Set of Circlip Pliers	65, 66, 68, 282, 283, 288	Twistor®16 – Self-Adjusting Crimping Pliers for wire ferrules	186
Set of Mounting Tools	177	Universal cross jaw tweezers	270
Set of Pliers Wrenches	104	Universal Grip Pliers	52
Shears for KEVLAR® fibres	140	Universal Keys	148
Sheet Metal Nibbler	141	Universal Knife	137
Siphon and Connector Pliers	121	Universal Stripping Tools	39, 40, 41
Slip Joint Pliers	106	Universal Tweezers / ESD	216, 264, 266, 271
SmartGrip® – Water Pump Pliers	108	Upholstery Pliers	145
SMD Precision Tweezers / ESD	267	Vinyl S	
Snipe Nose Side Cutting Pliers	13, 14, 209, 210	X-Cut® – Compact Diagonal Cutters	85, 213
Sockets with Torx drive	230	hears	139
Special Retaining Ring Pliers for retaining rings on shafts	64	Water Pump Pliers	109, 110, 112–116, 118, 119, 214, 215, 281
Spring Hose Clamp Pliers	143	Welding Grip Pliers	52
Stand Mats	237	Wire Rope and ACSR-Cable Cutters	165, 221
Steel Fixers' Nippers	74	Wire Rope Cutters	156, 164
StepCut® – Cable Shears	153	Wire Stripper for fibre optics	30
Stork Beak Pliers	14, 210	Wire Stripping Tool for coax and data cable	37
Stripping Knives	234	WireStripper	9
Stripping Pliers	32, 207		
Stripping Tool for coax cables	36, 37		
Stripping Tool for data cables	38		
Stripping Tool for fibre optics cable	31		
Stripping Tool for flat and round cables	38		
Stripping Tools	36		
Stripping Tools for spiral cutting	35		
Stripping Tools with scalpel blade	34		
Stripping Tweezers for coated wire	31		
StriX® – Insulation strippers with cable shears	33, 205		
Tear-off Pliers for vehicle bodywork	73		
Telephone Pliers	47		
T-handle	230		
Tile Breaking Pliers	146		
Tile Nibbling Pincer	145		
Titanium Tweezers	269		
Tool bag "Classic" Electric	327		

It is not permissible to copy the catalogue or parts of it in any way without our approval.

Illustrations, dimensions and weights are just approximate. No liability is assumed for misprints or errors.

Printed in the Federal Republic of Germany.

KNIPEX-Werk C. Gustav Putsch KG 2023



- 1 Point
- 2 Gripping surface
- 3 Recess (pipe grip)
- 4 Additional cutting edge
- 5 Jaw
- 6 Flank

Direction and position of the cutting edges

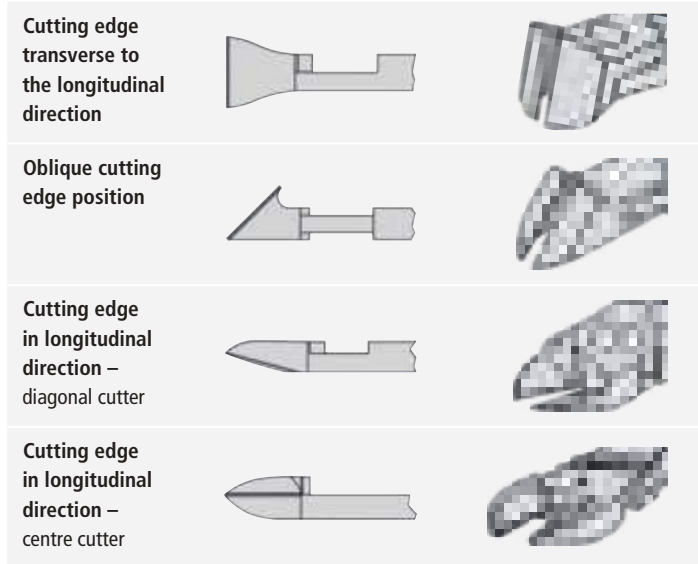

Cutting edge shapes DIN ISO 5742

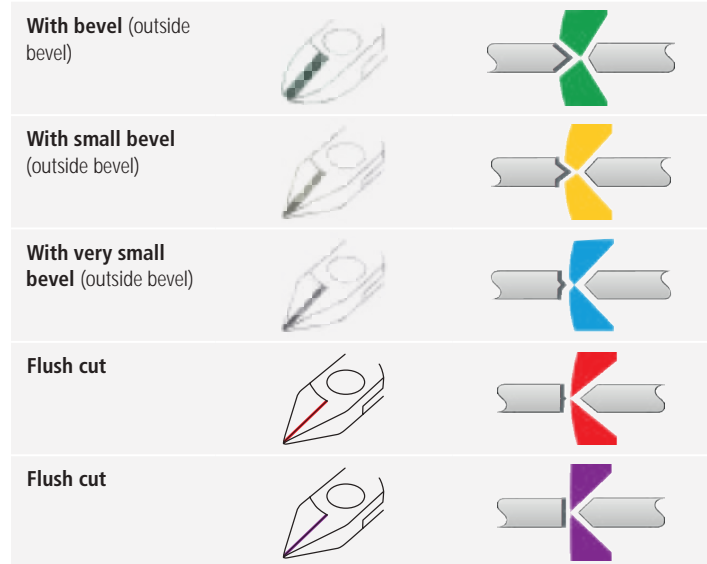

Joint types

<p>Lap joint</p> <p>With the lap joint, which is used on carpenters' pincers, concretors' nippers and high leverage diagonal cutters, the two halves of the pliers lie on top of each other without being milled out. The pliers handle can thus be designed to be very robust.</p>	
<p>Single joint</p> <p>With the single joint, half the thickness of each pliers handle is milled. Both pliers handles can thus be fitted into one another. The outer sides in the rivet area are smooth and not indented.</p>	
<p>Box joint</p> <p>One handle on the pliers is slit. The other handle is pushed through this slot. This joint connection can withstand a high level of load and strain because the joint bolt is supported on both sides and the inside handle is guided on both sides.</p>	
<p>Slip joint</p> <p>Slip joints enable optimal adaptation of the gripping jaws of pliers to various workpiece sizes. The opening width of the jaws is increased or decreased for this purpose. This occurs through shifting the two pliers handles with respect to one another.</p>	

Safety instruction

- > Each tool should only be used for its specified purpose.
- > When using cutting pliers: beware of wire ends flying off. Wear protective goggles and – if needed – gloves. Be aware of bystanders!
- > Only handles marked with the symbol 1000 V are insulating.



Care instructions

A drop of oil (e.g. WD-40®) on the polished surfaces and in the joint keeps your pliers in good working order and extends their service life!



Basic jaw shapes

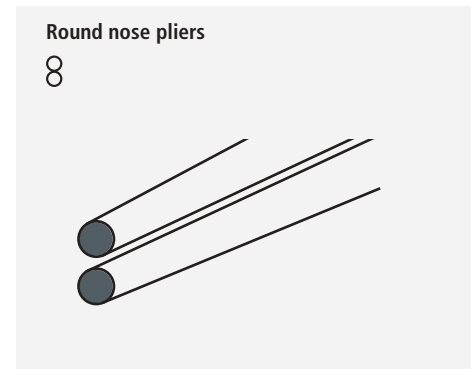
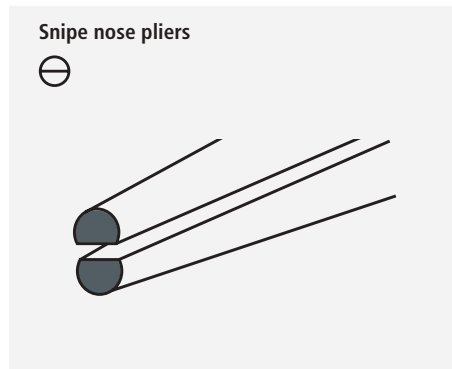
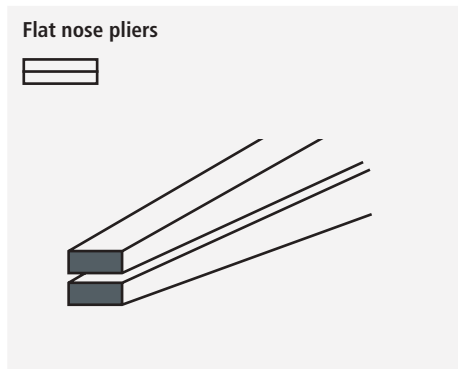

Examples of different handle types on a pair of pliers



Straight handles, fully-metal design without plastic grips are used when the hand must be placed at various positions when gripping. This is often the case with carpenters' pliers and concretors' nippers.



S-shaped handles, thin plastic coatings render pliers slip resistant and pleasant to grip. They support a precise hand position, which can be useful in screwing motions, for example. The typical handle for water pump pliers.



Curved handles, thin plastic coatings support the hand at the front and rear. This is always beneficial where high forces are required, for example with diagonal cutters.



Multi-component grips Compared to handles with a thin plastic coating, comfort handles offer the hand a larger contact surface, enabling better distribution of force and thus making work more comfortable.



VDE*-insulated handles, multi-component grips Insulated grips for working on electrical systems. Approved to DIN EN/IEC 60900, these pliers comply with significantly more stringent technical and safety standards.







VDE*-insulated handles with dip-insulation The dipped VDE-handles guarantee the same electrical protection as other VDE insulated handles. In particular, energy companies use these different looking VDE-pliers to help prevent the wrong tool from being used.







ESD-grips, multi-component grips** Dissipative sleeves enable a gradual, controlled equalisation of any prevailing differences in electric potential between the operator and sensitive electronic components.









* Association for Electrical, Electronic and Information Technologies
 ** electrostatic discharge

Cutting value table

Article No.	Length	 Ø mm	 Ø mm	 Ø mm	 Ø mm
020	180			2,5	2,0
	200			2,8	2,2
	225			3,0	2,5
030	140		2,8	1,8	
	160		3,1	2,0	
	180		3,4	2,2	
	200		3,8	2,5	
	250		3,8	2,5	
08 0	110		2,5	1,6	
08 2	145		3,0	2,0	
09 01/02/11/12	240		4,6	3,0	
13 0	160		2,5	1,6	
13 4	165		3,2	2,2	
19 0	130		2,2	1,6	
23 01	140	2,5	1,6		
25 01/03	125		2,2	1,6	
25 0/21/25/26	140		2,5	1,6	
	160		2,5	1,6	
26 1/26 2	200		3,2	2,2	
50 0	160		1,8		
	180		2,0		
	210		2,2		
	225		2,2		
	250		2,2		
	300		2,4		
51 01	210		1,8		
55 00 300	300	2,0 - 3,0			
58 30 225	225	2,0			
61 0	200	1,0 - 6,0	4,0	3,5	3,0
62 12	120	0,3 - 1,0	0,7		
64 0	115	2,0	1,0	0,6	
64 11	115	1,4	0,8		
64 12	115	1,4	0,8		
64 22	115	0,8			
64 32	120	1,5	1,0	0,5	
64 42	115	1,5	1,0	0,5	
64 52	115	1,3			
64 62	120	0,6			
64 72	120	1,5			
67 0	140	4,0	3,1	2,0	1,5
	160	4,5	3,4	2,5	2,0
	200	5,0	3,8	3,0	2,5
68 01	160	4,0	2,8	2,3	
	180	4,0	3,2	2,5	
	200	4,0	3,5	2,8	
	280	4,5	4,0	3,2	
69 0	130	0,4 - 2,0	1,3	1,0	0,8
70	110	3,0	2,0	1,2	
	125	3,0	2,3	1,5	
	140	4,0	2,5	1,8	
	160	4,0	3,0	2,0	
	180	4,0	3,0	2,5	
71	160	5,3	4,4	3,2	3,0
	200	6,0	5,2	4,0	3,6
	250		5,6	4,0	3,8

Article No.	Length	 Ø mm	 Ø mm	 Ø mm	 Ø mm
73 0	160	4,8	3,8	2,7	2,2
73 7	180	5,5	4,6	3,2	3,0
74 0	140		3,1	2,0	1,5
	160		3,4	2,5	2,0
	180		3,8	2,7	2,2
	200		4,2	3,0	2,5
	250		4,6	3,5	3,0
74 91	250	5,0	5,0	3,8	3,5
75 02	125	0,2 - 1,3	1,0	0,6	0,4
75 12	125	0,2 - 1,3	1,0	0,6	0,4
75 22	125	0,2 - 1,3	0,9	0,4	0,3
75 52	125	0,2 - 0,8	0,5	0,3	
76 01/03/05/12	125	0,4 - 3,0	2,3	1,5	0,6
76 22	125	0,4 - 2,5			
76 81	125	0,4 - 1,7	1,3	0,8	
77 01/02	115	0,3 - 1,6	1,2	0,6	
	130	0,3 - 2,0	1,5	0,8	
77 11/12	115	0,3 - 1,6	1,2	0,6	
77 21	115 N	0,3 - 1,3	1,0		
	130	0,3 - 1,6	1,3		
77 22	115	0,3 - 1,3	1,0		
	130	0,3 - 2,0	1,5		
77 32	115	0,3 - 1,3	1,0	0,5	
77 41	115	1,3	0,8		
77 42	115	0,3 - 1,3	0,8		
	130	0,3 - 1,6	1,3		
77 52	115	0,3 - 1,0	0,8	0,5	
77 72	115	0,3 - 0,8			
78 03/13	125	0,2 - 1,6	1,0		
78 03	140	0,2 - 2,1	1,2		
78 23	125	0,2 - 1,0	0,6		
78 31/41	125	0,2 - 1,0			
78 61/71	125	0,2 - 1,6	1,2		
78 61	140	0,2 - 2,1	1,4		
78 81/91	125	0,2 - 1,6	1,2	0,6	
79 02	120	0,2 - 1,4	1,0	0,6	
79 02	125	0,2 - 1,7	1,3	0,7	
79 12	125	0,3 - 1,7	1,3	1,0	0,6
79 22	120	0,1 - 1,3	0,8		
79 22	125	0,1 - 1,7	1,0		
79 32	125	0,2 - 1,5	1,1	0,6	
79 42	125	0,1 - 1,5	0,8		
79 52	125	0,2 - 1,3	0,9	0,5	
79 62	125	0,1 - 1,3	0,8		
99 0	200		1,8	1,4	
	220		2,4	1,6	
	250		2,4	1,6	
	280		2,8	1,8	
	300		3,1	1,8	
99 1	250		3,3	1,8	
	300		3,8	2,0	

Wire classes

	Material examples	Type of wire	Tensile strength		
			N/mm ²	kp/mm ²	
	Copper, plastics	soft	220	22	
	Nail, wire pin	medium-hard	750	75	
	Wire rope strand, steel wire	hard	1800	180	
	Spring steel wire	piano wire	2300	230	

Note

The maximum values always indicate the performance limit under the most favourable cutting conditions, when the wire is placed as near as possible to the joint.

Structure of article number



Example of the item number on the pliers handle

Basic model e. g. KNIPEX Cobra® Hightech Water Pump Pliers	Style e. g. straight	Finish e. g. head polished, handles with multicompo- nent grips	Length e. g. 250 mm	Accessory e. g. Tethered- Tools- Programm
87	0	2	250	T



Safe working: very stable tether attachment, firmly welded to the handle grip for attaching a safety cord or adaptor sling

Head / handles

0

Pliers black
atramentized,
head polished



1

Head polished,
handles plastic
coated



2

Head polished,
handles with
multi-component
grips



3

Pliers chrome
plated, handles
plastic coated



4

Pliers chrome plated



5

Pliers chrome
plated, handles with
multicomponent
grips

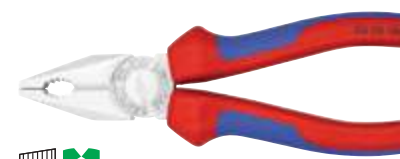

6

Pliers chrome plated,
handles insulated with
multi-component grips,
VDE-tested
DIN EN/IEC 60900

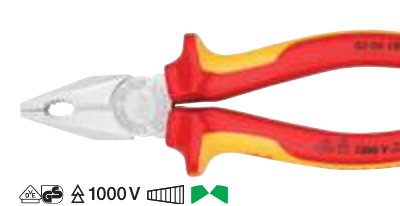

7

































































Pliers chrome plated,
handles with dipped
insulation, VDE-tested
DIN EN/IEC 60900





SYMBOLS

Pictograms

	Packing unit		W-crimp		Retaining ring, straight
SB	Carded pliers		Hexagonal crimp		Retaining ring, diagonal
BK	Pliers in a blister		Square crimp		Grip ring
ESD 	Electrostatic discharging, dissipative		Solarlok® crimp		Flat jaws
	Insulated according to IEC 60900, usable up to 1000 V AC/1500 V DC		Western crimp		Flat and pointed jaws
	VDE tested, also in compliance with GPSG (Equipment and Product Safety Act)		Trapezoidal crimp front		Half-round jaws
	Cu- + Al-multi-conductor cable, solid and multi-stranded		Hexagon		Round jaws
	Wire rope		Hexagonal screw		Angle
	Ribbon cable		Slotted screw		Smooth gripping surfaces
	Steel wire armoured cable (SWA)		Cross recessed screw		Smooth-serrated gripping surfaces
	ACSR cable		PlusMinus cross recessed screw		Knurled gripping surfaces
	Soft wire		Pozidriv cross recessed screw		Cross-hatched, knurled gripping surfaces
	Medium hard wire		Torx		Centre cutter
	Hard wire		With driving square 3/8"		Cutting edges with bevel
	Piano wire		With driving square 1/2"		Cutting edges with small bevel
	Square crimp automatic		Internal square 3/8"		Cutting edges with very small bevel
	Hexagonal crimp automatic		Internal square 1/2"		Cutting edges without bevel
	Four mandrel crimp		Hexagonal socket		For flush cut of soft materials
	Mandrel crimp		12-point		Mechanically tested in accordance with the Equipment and Product Safety Act
	Trapezoid crimp		With opening spring		Conforms to a European directive
	Oval crimp		With lead catcher		WEEE marking (Waste Electrical and Electronic Equipment Directive)
	F-crimp		Internal circlip		
	Trapezoid indent crimp		External circlip		



KNIPEX-Werk
C. Gustav Putsch KG

42337 Wuppertal

Tel +49 202 47 94-0

Fax +49 202 47 74 94

info@knipex.com
www.knipex.com