



**EGLO**  
my light | my style



**2023/24**

**INTERIOR LIGHTING**

WOHNRAUMLEUCHTEN  
LUMINAIRES INTÉRIEURS





Dear business partners and loyal EGLO friends,

We are thrilled to present our new main EGLO catalogue. With this catalogue, we want to showcase our extensive collection of high-quality luminaires, designed with meticulous attention to detail and a focus on design and quality.

At EGLO, environmental sustainability is a top priority. We ensure that our luminaires are produced in a way that conserves resources as much as possible. Additionally, the durability of our products is of great importance to us. We want to do our part to guarantee you find beautiful yet sustainable products for your home with EGLO. Many of our luminaires feature energy-saving LED technology, which helps you save on electricity costs and protect the environment.

We take pride in offering a wide range of high-quality luminaires at affordable prices, to ensure you find the perfect fit for your living needs in our catalogue.

We hope you enjoy browsing through our catalogue and look forward to helping you choose the perfect luminaire.

Geschätzte Geschäftspartner\*innen, treue EGLO Freund\*innen,

wir freuen uns sehr, Ihnen den neuen Hauptkatalog von EGLO präsentieren zu können. Mit diesem Katalog möchten wir Ihnen unsere umfangreiche Kollektion von hochwertigen Leuchten vorstellen, die wir mit viel Liebe zum Detail und einem besonderen Fokus auf Design und Qualität entworfen haben.

Auch das Thema Umwelt spielt bei EGLO eine wichtige Rolle. Wir achten darauf, dass unsere Leuchten möglichst ressourcenschonend produziert werden. Darüber hinaus ist uns die Langlebigkeit unserer Produkte wichtig. Wir möchten unseren Beitrag dazu leisten, dass Sie nicht nur schöne, sondern auch nachhaltige Produkte bei uns finden. Viele unserer Leuchten verfügen über energiesparende LED-Technologie, die Ihnen nicht nur hilft Stromkosten zu sparen, sondern auch die Umwelt schont.

Wir sind stolz darauf, Ihnen eine große Auswahl an hochwertigen Leuchten zu fairen Preisen anbieten zu können und sind uns sicher, dass Sie in unserem Katalog das perfekte Angebot für Ihre Wohnbedürfnisse finden werden.

Wir wünschen Ihnen viel Spaß beim Durchblättern unseres Katalogs und freuen uns darauf, Ihnen bei der Wahl der passenden Leuchte behilflich zu sein.

Chers partenaires commerciaux\*, fidèles amis d'EGLO\*,

Nous sommes très heureux de vous présenter le nouveau catalogue principal d'EGLO. Avec ce catalogue, nous souhaitons vous présenter notre vaste collection de luminaires haut de gamme, que nous avons conçus avec un grand souci du détail et un accent particulier sur le design et la qualité.

Le thème de l'environnement joue également un rôle important chez EGLO. Nous veillons à ce que nos luminaires soient produits en préservant le plus possible les ressources. De plus, la longévité de nos produits est importante pour nous. Nous souhaitons apporter notre contribution pour que vous trouviez chez nous, non seulement de beaux produits, mais aussi des produits durables. Beaucoup de nos luminaires sont dotés de la technologie LED à faible consommation d'énergie, qui vous permet non seulement d'économiser des frais d'électricité, mais aussi de préserver l'environnement.

Nous sommes fiers de pouvoir vous proposer un grand choix de luminaires de qualité à des prix équitables et nous sommes certains que vous trouverez dans notre catalogue l'offre parfaite pour vos besoins en matière d'habitat.

Nous vous souhaitons beaucoup de plaisir à feuilleter notre catalogue et nous nous réjouissons de pouvoir vous aider à choisir le luminaire qui vous convient.



Mag. René Tiefenbacher  
CEO EGLO Group

# CONTENT

---

INHALT  
CONTENU



	<b>CONNECT.Z</b> ..... <b>10</b> CONNECT.Z CONNECT.Z		<b>SPOT &amp; TRACK LUMINAIRES</b> ..... <b>678</b> SPOT- & SCHIENENLEUCHTEN SPOT & LUMINAIRES SUR RAIL
	<b>EGLO ACCESS</b> ..... <b>112</b> EGLO ACCESS EGLO ACCESS		<b>CLIP &amp; PLUG LUMINAIRES</b> ..... <b>772</b> KLEMM- & STECKERLEUCHTEN LUMINAIRES À PINCE & SUR PRISE
	<b>LIGHTING FAMILIES</b> ..... <b>130</b> FABRIC LUMINAIRES STOFFLEUCHTEN LUMINAIRES À TEXTIL		<b>TABLE &amp; FLOOR LUMINAIRES</b> ..... <b>780</b> TISCH- & STEHLEUCHTEN LUMINAIRES DE TABLE & LAMPADAIRES
	<b>LIGHTING FAMILIES</b> ..... <b>206</b> WOOD LUMINAIRES HOLZLEUCHTEN LUMINAIRES À BOIS		<b>OFFICE TABLE &amp; FLOOR LUMINAIRES</b> ..... <b>826</b> OFFICE TISCH- & STEHLEUCHTEN LUMINAIRES DE TABLE & LAMPADAIRES À BUREAU
	<b>LIGHTING FAMILIES</b> ..... <b>228</b> STANDARD LUMINAIRES STANDARD LEUCHTEN LUMINAIRES STANDARD		<b>CHILDREN LUMINAIRES</b> ..... <b>862</b> KINDERLEUCHTEN LUMINAIRES POUR ENFANTS
	<b>LIGHTING FAMILIES</b> ..... <b>336</b> GLASS CHANDELIERS LEUCHTENFAMILIEN FAMILIES DE LUMINAIRES		<b>KITCHEN &amp; FUNCTION LUMINAIRES</b> ..... <b>868</b> KÜCHEN- & FUNKTIONSLAUCHTEN LUMINAIRES FONCTIONNELS & DE CUISINE
	<b>HANGING &amp; PENDANT LUMINAIRES</b> ..... <b>346</b> HÄNGE- & PENDELLEUCHTEN LUMINAIRES SUSPENSIONS		<b>ACCESSORIES</b> ..... <b>876</b> ZUBEHÖR ACCESSOIRES
	<b>WALL &amp; CEILING LUMINAIRES</b> ..... <b>472</b> WAND- & DECKENLEUCHTEN APPLIQUES & PLAFONNIERS		<b>INDEX &amp; LEGEND</b> ..... <b>884</b> INDEX & ERKLÄRUNG INDEX & LÉGENDE
	<b>BATH &amp; MIRROR LUMINAIRES</b> ..... <b>616</b> BAD- & SPIEGELLEUCHTEN LUMINAIRES DE BAIN & MIROIR		

# EGLO TREND HIGHLIGHTS 2023/24

The EGLO design team has once again drawn on current mega-trends as a source of inspiration for the 2023/24 season. The new EGLO products' use of shape and colour, choice of materials, and overall aesthetic harmonise perfectly with both contemporary and future living trends. Minimalism and the increasingly popular use of materials and colours such as brass and earth tones have had a particularly strong influence on this season's luminaire designs.

Auf Basis der Megatrends hat sich das Design-Team von EGLO auch für die Saison 2023/24 inspirieren lassen. Mit ihrer Formsprache, Farbgebung sowie den verwendeten Materialien fügen sich die EGLO Neuheiten in die aktuellen wie auch zukünftigen Wohntrends ein. Der Trend des Minimalismus sowie die Verwendung von Materialien und Farben wie Messing und Erdtöne haben auf die aktuellen Leuchten-Designs besonderen Einfluss genommen.

Sur la base des mégatendances, l'équipe de conception EGLO a également été inspirée pour la saison 2023/24. Avec leur langage visuel, leur palette de couleurs et les matériaux utilisés, les innovations EGLO s'intègrent dans les tendances de la vie d'aujourd'hui et de demain. La tendance au minimalisme et l'utilisation de matériaux et de couleurs tels que le laiton et les tons de terre ont eu une influence particulière sur les conceptions actuelles de nos luminaires.

**Minimalism** – The art of less, the conscious reduction of shapes and colours to the bare essentials, is reflected in our luminaires. Clear and simple shapes and plain colours combine to create a calm atmosphere, in keeping with the maxim "less is more". Warm grey tones and timber elements give the room a welcoming touch, adding atmospheric highlights and offering a harmonious stage for your entire living space to work its magic without any distractions.

**Minimalismus** – Der bewusste Verzicht und die Kunst, Form und Farbe auf ein Minimum zu reduzieren, spiegelt sich in unseren Leuchten wider. Frei nach dem Prinzip „Weniger ist mehr“ sorgen klare und einfache Formen sowie schlichte Farben für eine ruhige Atmosphäre. Für die nötige Gemütlichkeit setzen warme Grautöne oder Holzelemente stimmungsvolle Akzente und bieten eine harmonische Bühne, um den gesamten Raum ganz ohne Ablenkung für sich wirken zu lassen.

**Le minimalisme** – Nos lampes reflètent un renoncement volontaire et l'art de réduire au minimum formes et couleurs. Selon le principe « faire plus avec moins », des formes claires et simples et des couleurs unies créent une atmosphère paisible. Pour le confort, des tons gris chauds ou des éléments en bois mettent en place une ambiance agréable et un décor harmonieux pour vous permettre de travailler dans une pièce sans aucune distraction.



ALMUDAINA



## CENCIARA

**Brass** – Brass so popular back in the 50s and 60s, is currently enjoying a new wave of popularity. Skilfully paired with contrasting materials, the gleaming metallic hues of brass bring a touch of luxury to living spaces without appearing old-fashioned. We have incorporated the high-quality material into our new luminaire models and combined it with diverse other materials to create captivating modern designs that can be integrated into a variety of interiors, from urban to classical to minimalist.

**Messing** – Der bereits in den 50er und 60er Jahren so populäre Messingtrend erfreut sich aktuell an neuer Beliebtheit. Gekonnt kombiniert und kontrastreich in Szene gesetzt, bringt Messing mit seinem strahlenden Metallton einen Hauch von Luxus in die Wohnräume, ohne altmodisch zu wirken. Das hochwertige Material haben wir in unsere neuen Leuchten-Modelle einfließen lassen und in Kombination mit verschiedenen Materialien charmante und moderne Designs geschaffen, die sich in unterschiedliche Einrichtungen von urban über klassisch bis hin zu minimalistisch integrieren lassen.

**Le lait** – La tendance du lait, déjà si populaire dans les années 50 et 60, est actuellement à nouveau au goût du jour. Habilement combiné et mis en scène avec de riches contrastes, le lait avec sa teinte métallique brillante apporte une touche de luxe aux espaces de vie sans paraître démodé. Nous avons incorporé ce matériau de haute qualité dans nos nouveaux modèles de luminaires et, en combinaison avec divers matériaux, avons créé des designs charmants et modernes qui peuvent être intégrés à des aménagements différents, qu'ils soient notamment urbains, classiques ou encore minimalistes.



**Warm earth tones** – The very popular back-to-nature trend has also brought about a significant shift in the field of design. More and more people have been embracing a return to nature in recent years and the associated use of natural materials has also left its mark on the world of colour, heralding the rise of brown as the new black. The colour brown in all its many facets can be beautifully paired with almost any other colour and, thanks to its diverse earthy tones, not only lends our living spaces a touch of naturalness, but also conveys a sense of warmth and comfort. Combining this year's popular colour trend with wood and brass elements helps accentuate its distinctive appeal.

**Warme Erdtöne** – Der starke Trend hin zu mehr Natürlichkeit hat auch im Design einen bedeutsamen Wandel bewirkt. Die in den letzten Jahren deutlich an Bedeutung gewonnene Verbundenheit zur Natur und die damit einhergehende Verwendung von natürlichen Materialien hat auch die Farbwelt geprägt und lässt Braun als das neue Schwarz triumphieren. Braun in all seinen Facetten lässt sich hervorragend kombinieren und verleiht unseren Wohnräumen durch seine vielfältigen Erdtöne nicht nur einen Hauch von Natürlichkeit, sondern vermittelt Gemütlichkeit und Behaglichkeit gleichermaßen. Die Kombination mit Holz oder Messing verleiht der neuen Trendfarbe ihre besonderen Akzente.

**Des tons chauds de terre** – La forte tendance vers un caractère plus naturel a également entraîné un changement significatif dans notre conception. Le lien avec la nature, qui a grandement gagné en importance ces dernières années, et l'utilisation associée de matériaux naturels ont également façonné l'univers des couleurs : c'est ainsi que le brun a détrôné le noir. Le brun sous toutes ses facettes peut être parfaitement combiné et, avec ses divers tons de terre, non seulement donner à nos salons une touche naturelle, mais aussi procurer confort et bien-être dans le même temps. La combinaison de cette nouvelle couleur tendance avec le bois ou le laiton lui confère ses accents si particuliers.



PODERE

# Look out for this Logo!

Achten Sie auf das Logo!

Soyez attentif au logo !

## What is a forest?

A peaceful oasis, the green lungs of the world, and an adventure playground for children of all ages!

The Forest Stewardship Council® (FSC®) is a global, not-for-profit organisation dedicated to the promotion of responsible forest management worldwide. The FSC® defines standards for responsible forest management in accordance with established principles that are developed and supported by stakeholders from the environmental, social and economic spheres. For more information, please see [www.fsc.org](http://www.fsc.org).

## Was ist Wald für uns?

Eine Oase der Ruhe, die Lunge der Welt oder ein Abenteuerspielplatz für große und kleine Kinder!

Das Forest Stewardship Council® (FSC®) ist eine globale, gemeinnützige Organisation, mit dem Zweck verantwortungsvolle Waldbewirtschaftung weltweit zu fördern. FSC® definiert Standards für eine verantwortungsvolle Waldbewirtschaftung nach festgelegten Prinzipien, die von Interessenvertretern aus den Bereichen Umwelt, Soziales und Wirtschaft entwickelt und getragen werden. Für weitere Informationen besuchen Sie [www.fsc.org](http://www.fsc.org).

## Que représente la forêt pour nous ?

Une oasis de calme, les poumons du monde ou un terrain de jeu d'aventure pour les enfants de tous âges !

Le Forest Stewardship Council® (FSC®) est une organisation internationale à but non lucratif dont le but est de promouvoir une gestion forestière responsable dans le monde entier. Le FSC® définit des normes de gestion forestière responsable selon des principes établis qui sont développés et soutenus par les parties prenantes des secteurs environnemental, social et économique. Pour plus d'informations, veuillez consulter [www.fsc.org](http://www.fsc.org).

Look out for FSC® -certified products!  
Achten Sie auf FSC® -zertifizierte Produkte!  
Soyez attentif aux produits certifiés FSC® !



The mark of  
responsible forestry

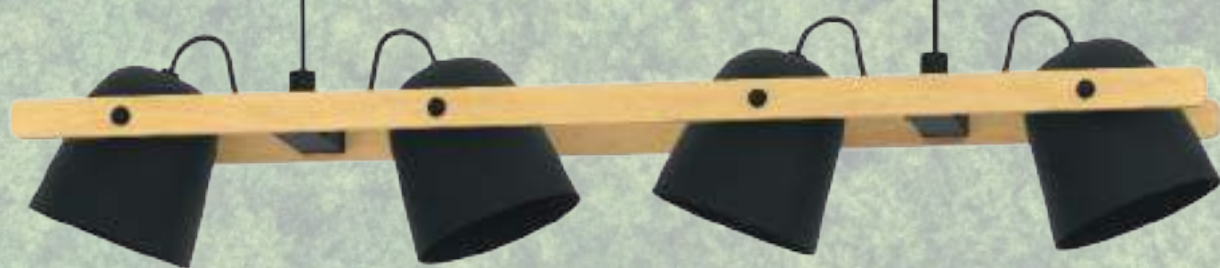

900883



# DIGITAL CATALOGUE



This year, we are also making the main catalogue in front of you available online, including lots of extra information and additional features. In addition to search and filter functions, the online catalogue includes extensive product photos, videos and additional information, complementing the paper edition wonderfully. Take a look at

<https://catalogue.eglo.com>

In diesem Jahr präsentieren wir den vor Ihnen liegenden Hauptkatalog wieder als Online-Katalog mit vielen Zusatzinformationen und zusätzlichen Features. Neben Such- und Filterfunktionen bietet der Online-Katalog mit reichhaltigen Produktabbildungen, Videos und zusätzlichen Informationen einen erheblichen Mehrwert zur gebundenen Ausgabe. Klicken Sie sich rein unter

<https://catalogue.eglo.com>

Cette année, nous présentons à nouveau une version en ligne du catalogue général. Cette version contient de nombreuses informations et fonctionnalités complémentaires. Outre les fonctionnalités de recherche et de filtrage, le catalogue en ligne propose de nombreuses illustrations de produits, des vidéos et des informations complémentaires : une valeur ajoutée considérable par rapport à la version papier. Cliquez ici pour le découvrir :

<https://catalogue.eglo.com>



# EGLO CONNECT.Z

EGLO CONNECT.Z  
EGLO CONNECT.Z

**EN EGLO CONNECT.Z**

Discover the smart world of light. You will find everything about control options, functions and beneficial use in everyday life on the following pages. Let yourself be surprised by the EGLO connect.z range.

**DE EGLO CONNECT.Z**

Entdecke die smarte Welt des Lichtes. Alles über Steuerungsmöglichkeiten, Funktionen und die vorteilhafte Anwendung im Alltag finden Sie auf den folgenden Seiten. Lassen Sie sich vom EGLO connect.z Sortiment überraschen.

**FR EGLO CONNECT.Z**

Découvrez le monde intelligent de la lumière. Vous trouverez tout sur les options de contrôle, les fonctions et l'utilisation bénéfique dans la vie quotidienne dans les pages suivantes. Laissez-vous surprendre par la gamme EGLO connect.z.

connect.2

Discover the smart world













































 zigbee

 Bluetooth®



# OVERVIEW

EGLO CONNECT.Z  
EGLO CONNECT.Z  
EGLO CONNECT.Z

 CONNECT-Z 21	 CONNECT-Z SENSOR 21	 CONNECT-Z SWITCH 21	 ANDREAS-Z 23	 ANCHORENA-Z 24-25	 KOKOMO-Z 26	 HORNWOOD-Z 26	 YUKU-Z 27
 PORTICO-Z 27	 BARBANO-Z 28-29	 ROMAO-Z 30	 TOLLOS-Z 31	 GINESTRONE-Z 33	 SALVILANAS-Z 34-35	 MARGHERA-Z 36-37	 SIMOLARIS-Z 38-39
 FRAIOLI-Z 40-41	 LOBINERO-Z 42	 ZILLERIO-Z 42	 ANDABAIA-Z 43	 TABIANO-Z 44	 LOMALTAS-Z 45	 PARANDAY-Z 46-47	 PARRAPOS-Z 48-49
 CALAGRANO-Z 50-51	 MONTEMORE- LOS-Z 52-53	 GENOVESE-Z 53	 ROVITO-Z 54-57	 PADROGIANO-Z 58-60	 SAVATARILA-Z 62-63	 SALITERAS-Z 63	 TURCONA-Z 64-67
 SARSINA-Z 68-69	 SALOBRENA-Z 70-73	 HERRORA-Z 74	 FUEVA-Z 76-87	 TOTARI-Z 88-89	 LANCIANO-Z 90	 SILERAS-Z 91	 TELIMBELA-Z 92-93
 CAMINALES-Z 94	 SALICETO-Z 95	 CAROSSO-Z 96-97	 LED STRIPE-Z 98-99	 LM_LED_E27 100-101	 LM_LED_E14 101	 LM_LED_GU10 101	



This product is available in different colors and shapes. / Dieser Artikel ist in unterschiedlichen Farben und Formen verfügbar. / Cet article est disponible en différentes couleurs et formes.



## connect.z combines two control technologies in one system

connect.z vereint zwei Steuerungstechnologien in einem System

connect.z réunit deux technologies de commande au sein d'un même système



ZigBee is far and away the most widely used standard in the smart home world.

ZigBee ist der am weitesten verbreitete Standard in der Smart Home Welt.

ZigBee est le protocole le plus répandu au monde dans le domaine du Smart Home.

### ADVANTAGES :

- › Mesh network
- › Direct connection with Amazon Echo and Google Home
- › Compatible with products from different manufacturers
- › High level of security
- › Easy setup
- › Energy efficient

### VORTEILE:

- › Mesh-Netzwerk
- › Direkte Verbindung mit Amazon Echo und Google Home
- › Herstellerübergreifend kompatibel
- › Hohe Sicherheit
- › Einfache Einrichtung
- › Energieeffizient

### AVANTAGES:

- › Réseau maillé
- › Connexion directe à Amazon Echo et Google Home
- › Compatible indépendamment du fabricant
- › Sécurité élevée
- › Installation facile
- › Économe en énergie



# connect.2



Bluetooth is an established standard in the digital world.  
Bluetooth ist ein etablierter Standard in der digitalen Welt.  
Bluetooth est un standard de communication reconnu dans le monde numérique.

#### ADVANTAGES:

- › Local & secure network
- › Protocol is mainly audio (low debit)
- › Mesh network: Elements are receivers and senders
- › Easy setup
- › Usable offline
- › Energy efficient

#### VORTEILE:

- › Lokales & sicheres Netzwerk Protokoll hauptsächlich Audio (Low Debit)
- › Mesh-Netzwerk: Elemente sind Empfänger und Sender
- › Einfache Einrichtung
- › Offline nutzbar
- › Energieeffizient

#### AVANTAGES:

- › Réseau local et sûr
- › Protocole essentiellement audio (bas débit)
- › Réseau maillé : les éléments sont l'émetteur et le récepteur
- › Installation facile
- › Utilisable hors-ligne
- › Économe en énergie

# Light up your world!

Bringen Sie Licht in Ihren Alltag!  
Illuminez votre quotidien !



connect.z offers a wide range of lamps and lighting equipment. Select products from the following options according to your needs:  
connect.z bietet ein großes Sortiment an Leuchten und Leuchtmitteln. Wählen Sie die Produkte ganz nach Ihren Bedürfnissen aus folgenden Varianten:  
connect.z propose une large gamme de luminaires et d'ampoules. Sélectionnez les produits en fonction de vos besoins parmi les variantes suivantes :

**Warm White**

**Neutral White**

**Tunable White**

Individual light from 50,000 white tones.  
Individuelles Licht aus 50.000 Weißtönen.  
Luminaire individuel à 50 000 tons de blanc.

**TW + RGB Colors**

Diverse lighting selection from 50,000 white tones and 16 million colours.  
Vielseitige Lichtauswahl aus 50.000 Weißtönen und 16 Mio. Farben.  
Sélection étendue de luminaires à 50 000 tons de blanc et 16 millions de couleurs.

Enjoy relaxing moments!  
Genießen Sie entspannte Momente!  
Profitez de moments de détente !

Stay focussed & efficient!  
Bleiben Sie konzentriert & leistungsfähig!  
Restez concentré(e) et performant(e) !

Start the day fresh every morning!  
Starten Sie jeden Morgen frisch in den Tag!  
Commencez la journée du bon pied !

Create the perfect atmosphere!  
Kreieren Sie Ihr perfektes Ambiente!  
Créez votre ambiance parfaite !



## Enjoy many useful convenience features: Es erwarten Sie viele nützliche Komfortfunktionen: De nombreuses fonctionnalités utiles vous attendent pour votre confort :



### TIMERS AND CALENDARS / TIMER UND ZEITPLÄNE/ MINUTERIE ET CALENDRIER

Make your daily life easier with timers and calendars.  
Wake up relaxed with the simulated sunrise.

Unterstützen Sie Ihren Alltag mit Timern und Zeitplänen. Entwickeln Sie eigene Lichtroutinen und machen Sie Ihr Leben leichter.

Facilitez-vous la vie à l'aide de la fonction minuterie et calendrier.  
Réveillez-vous en douceur grâce au simulateur de lever de soleil.



### LIGHT ALARM CLOCK / LICHTWECKER/ REVEIL LUMINEUX

You'd rather not start your day in a bad mood? Wake up relaxed with the simulated sunrise.

Keine Lust mit schlechter Laune in den Tag zu starten? Entspannt aufwachen mit dem simulierten Sonnenaufgang.

Pas envie de commencer la journée de mauvaise humeur ? Réveillez-vous en douceur grâce au simulateur de lever de soleil.



### DISCO FUNCTION/MODE / DISCOFUNKTION/MODUS/ FONCTION/MODE DISCO

For the perfect party mood, the disco function synchronises the light to the beat of your favourite songs.

Für die perfekte Partystimmung schaltet die Discofunktion das Licht passend zum Beat Ihres Lieblingssongs.

Pour une ambiance festive parfaite, la fonction disco enclenche le luminaire au rythme de votre chanson préférée.



### PRESENCE SIMULATOR / ANWESENHEITSSIMULATION/ SIMULATEUR DE PRESENCE

Protect your home with the convenient presence simulator. Variable time intervals allow the system to turn the lights on and off to simulate your presence at home and deter unwanted guests.

Schütze Sie Ihr Zuhause mit der komfortablen Anwesenheitssimulation. Dank variabler Zeitintervalle simuliert das System durch Ein- und Ausschalten der Beleuchtung die Anwesenheit im Haus und schreckt so ungebetene Gäste ab.

Protégez votre domicile à l'aide du très pratique simulateur de présence. Le système simule votre présence en allumant et en éteignant les lumières à intervalles variables et décourage ainsi les invités indésirables.



### VOICE COMMANDS / SPRACHSTEUERUNG/COMMANDE VOCALE

More convenient! Turn the light on whenever you want with only a voice command.

Noch komfortabler! Mit nur einem Sprachbefehl schaltet sich das Licht nach Ihren Wünschen an und aus.

C'est encore plus confortable ! Allumez votre luminaire comme vous le souhaitez d'une simple commande vocale.

## Control options

Steuerungsmöglichkeiten  
Possibilités de commande



Set your smart home as you prefer! With the app, voice commands, or remote control.

Steuern Sie Ihr Smart Home wie Sie es möchten! Via App, Sprachsteuerung oder mit der Fernbedienung.

Commandez votre Smart Home comme vous le souhaitez ! Via l'appli, la commande vocale ou la télécommande.



### APP CONTROL

Use the free app for smartphone or tablet.  
Nutzen Sie die kostenlose App für das Smartphone oder Tablet.  
Utilisez l'application gratuite pour smartphone ou tablette.



### VOICE COMMANDS

Use intelligent voice assistants such as Google Home and Amazon Alexa.  
Nutzen Sie intelligente Sprachassistenten wie Google Home und Amazon Alexa.  
Utilisez des assistants vocaux intelligents comme Google Home ou Amazon Alexa.



### REMOTE CONTROL

Use the practical remote connect.z operation at any time.  
Nutzen Sie auch jederzeit die praktische connect.z Fernbedienung.  
Vous pouvez aussi utiliser à tout moment la télécommande connect.z.



### CONNECT.Z ACCESSORIES

Use clever accessories such as the movement sensor and much more.  
Nutzen Sie cleveres Zubehör wie z.B. den Bewegungssensor uvm.  
Utilisez des accessoires malins tels que le capteur de mouvement et bien d'autres encore.



### DIMMER FUNCTION

Use the practical dimmer function via app, speech command or remote control.  
Nutzen Sie die praktische Dimmfunktion via App, Sprachbefehl oder Fernbedienung.  
Utilisez la fonction de gradation via l'appli, la commande vocale ou la télécommande.

# One system, many possibilities!

Ein System – viele Möglichkeiten!  
Un système, de nombreuses possibilités!

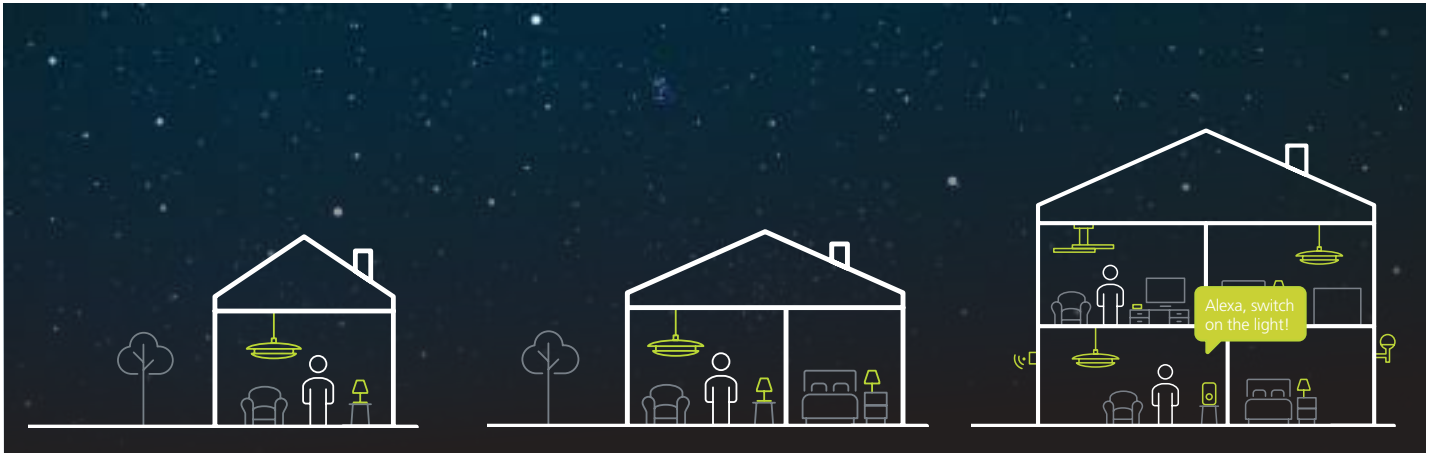

No matter how you start, you can integrate new products into your connect.z system at any time and gradually expand your smart home.  
Egal wie Sie starten, Sie können jederzeit neue Produkte in Ihr connect.z System integrieren und Ihr smartes Zuhause nach und nach erweitern.  
Quel que soit votre choix, vous pouvez à tout moment intégrer de nouveaux produits à votre système connect.z et améliorer progressivement votre maison intelligente.

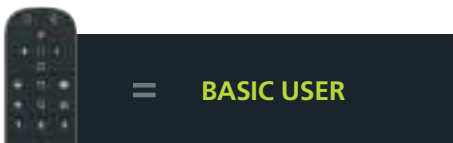

All you need to start is a connect.z product and the remote control. No internet connection is required and you have access to:

Sie benötigen zum Start lediglich ein connect.z Produkt und die Fernbedienung. Es wird kein Internetzugang benötigt und Sie haben Zugriff auf:

Pour démarrer, il vous suffit d'un produit connect.z et de la télécommande. Aucune connexion Internet n'est nécessaire. Vous avez accès aux :

#### Standard functions:

#### Standardfunktionen:

#### Fonctionnalités standard :

- › Select colour/ Farbauswahl/ sélection de couleur
- › Change colour/ Farbwechsel/ changement de couleur
- › Dim/ Dimmen/ gradation
- › Favourites (2x)/ Favoriten (2x)/ favoris (2x)
- › Groups (3x)/ Gruppen (3x)/ groupes (3x)
- › Candle mode/ Kerzenmodus/ mode bougie

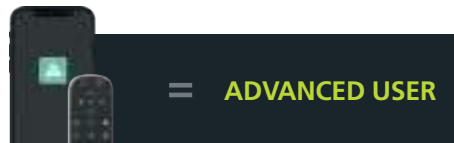

Besides the standard functions, would you also like access to the practical convenience features? Then you need only your smartphone or tablet and the Awox app. This app allows you to control your lights via Bluetooth®.

Sie möchten zu den Standardfunktionen auch noch Zugriff auf die praktischen Komfortfunktionen haben? Dann benötigen Sie nur Ihr Smartphone oder Tablet und die Awox App. Mit der App haben Sie die Möglichkeit, Ihre Leuchten über Bluetooth® zu steuern.

Outre les options standard, vous souhaitez également pouvoir utiliser les fonctionnalités de confort les plus pratiques ? Pour cela, vous avez seulement besoin de votre smartphone ou de votre tablette et de l'appli Awox. L'appli vous permet de commander vos luminaires via Bluetooth®.

#### Standard functions + convenience features/ Standardfunktionen + Komfortfunktionen / Fonctionnalités standard + confort

- › Light alarm clock/ Lichtwecker/ réveil lumineux
- › Presence simulation/ Anwesenheitssimulation/ simulateur de présence
- › Disco function/ Discofunktion/ fonction disco
- › Timers & timetables /Timer & Zeitpläne/ minuteur et calendrier
- › Accessories can be incorporated/ Einbindung von Zubehör möglich/ connexion d'accessoires possible



Use the system's full potential and control your smart home through the Awox app using WIFI or Bluetooth® as well as integrating a voice assistant into the system. This gives you:

Nutzen Sie das volle Potenzial des Systems und steuern Sie Ihr Smart Home über die Awox App mithilfe von WLAN oder Bluetooth® und integrieren Sie zusätzlich noch einen Sprachassistenten in das System. So mit erhalten Sie:

Exploitez tout le potentiel du système en commandant votre Smart Home grâce à l'appli Awox via le réseau Wi-Fi ou Bluetooth®, et intégrez également un assistant vocal au système. Vous obtenez ainsi :

#### Standard functions + convenience features + voice commands\*

#### Standardfunktionen + Komfortfunktionen + Sprachsteuerung\*

#### Fonctionnalités standard + confort + commande vocale\*

- › Amazon Alexa or Google Home/ Amazon Alexa oder Google Home/ Amazon Alexa ou Google Home

\* Use a voice assistant with integrated bridge.

\* Nutzen Sie einen Sprachassistenten mit integrierter Bridge.

\* Utilisez un assistant vocal avec Bridge intégré.

## You already have connect-c luminaires from the previous system! What now?

Sie besitzen bereits connect-c Leuchten des Vorgängersystems! Was nun?  
Vous disposez déjà de luminaires connect-c de l'ancien système! Que faire ?

No problem! The previous connect-c products are compatible with the new connect.z system.  
Kein Problem! Die bisherigen connect-c Produkte sind mit dem neuen connect.z System kompatibel.  
Aucun problème! Les anciens produits connect-c sont compatibles avec le nouveau système connect.z.

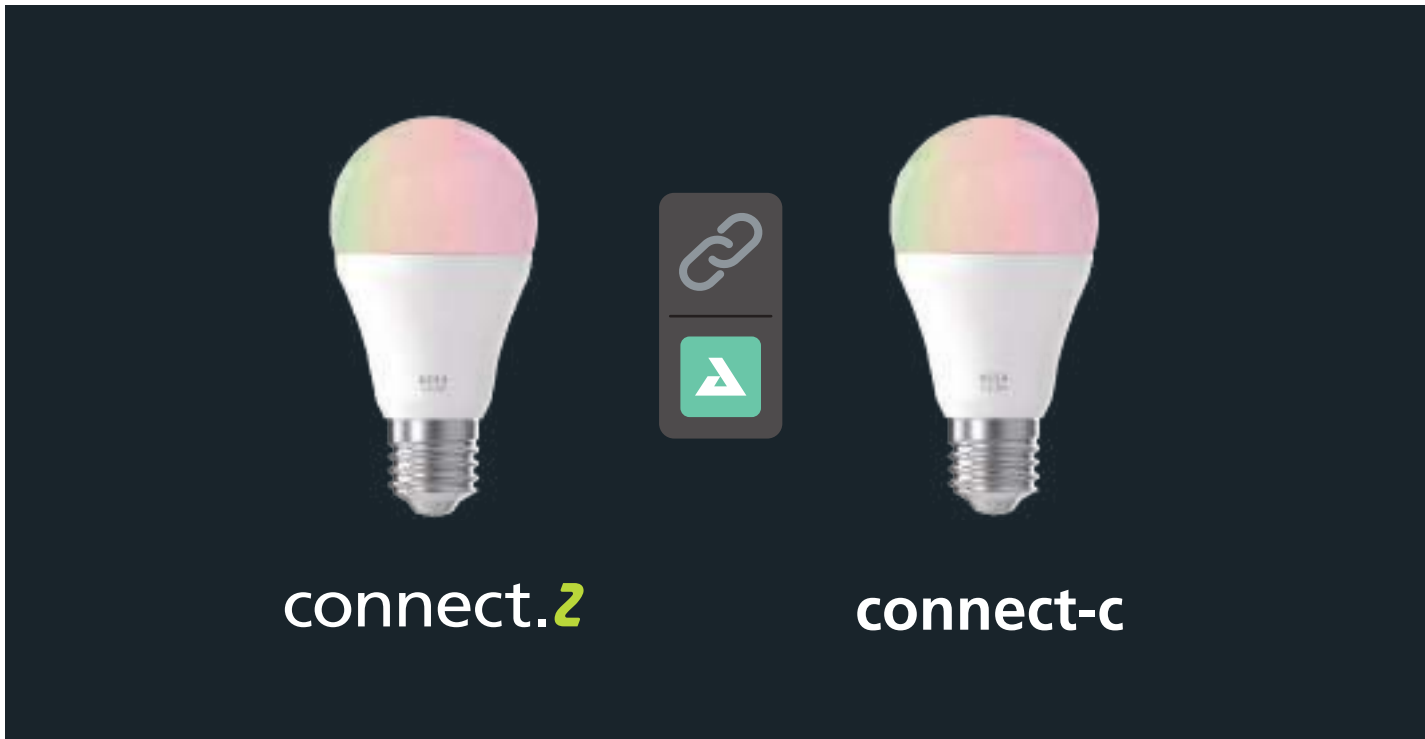

### EGLO connect-c - connect.z

The existing EGLO connect-c system is compatible with the new EGLO connect.z system in the Awox Homecontrol App. You do not have to switch from the existing Bluetooth low energy system to the new open protocol ZigBee 3.0. EGLO connect-c luminaires can be integrated in the Awox app.

### EGLO connect-c - connect.z

Das bestehende EGLO connect-c System ist mit dem neuen EGLO connect.z System in der Awox Homecontrol App kompatibel. Sie müssen nicht von dem bestehendem Bluetooth low energy System auf das neue offene Protokoll ZigBee 3.0 umsteigen. Leuchten von EGLO connect-c können in der Awox App eingebunden werden.

### EGLO connect-c - connect.z

Le système EGLO connect-c existant est compatible avec le nouveau système EGLO connect.z dans l'application Awox Homecontrol. Vous n'avez pas besoin de passer du système Bluetooth low energy existant au nouveau protocole ouvert ZigBee 3.0. Les luminaires EGLO connect-c peuvent être intégrés dans l'application Awox.



**99099**

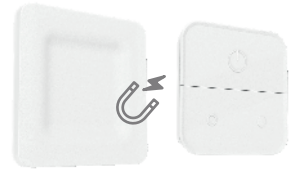

**900116**

The wall mount can be screwed or glued to smooth surfaces. The switch can be removed from its magnetic holder. With the three buttons, luminaires can be switched off, on and dimmed.

Die Wandhalterung kann geschraubt oder an glatte Oberflächen geklebt werden. Der Schalter kann aus seiner magnetischen Halterung herausgenommen werden. Mit den drei Tasten können Leuchten aus- und eingeschalten und gedimmt werden.

Le support mural peut être vissé ou collé sur une surface lisses. L'interrupteur peut être retiré de son support magnétique. Les trois boutons permettent d'éteindre, d'allumer et de faire varier l'intensité des luminaires.



**900116**

**99106**



Mounting bracket incl.

Montagehalterung inkl.

Support de montage incl.

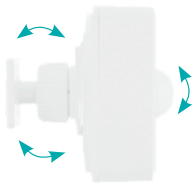

**99106**



120°, 12 m  
20 sec. - 10 min.



IP44

### 99099 CONNECT Z

remote control; plastic, grey  
Fernbedienung; Kunststoff, grau  
Télécommande; plastique, gris

L 122, B 54, H 18



AAA,  
R03P

1,5V



9 002759 990992



B 54

L 122

### 99106 CONNECT-Z SENSOR

accessory; plastic, white  
Zubehör; Kunststoff, weiss  
Accessoires; plastique, blanc

L 75, H 75, A 70



AA,  
LR6 HP

2900mA,  
1,5V

IP44



9 002759 991067

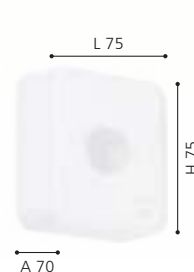

A 70

L 75

H 75

### 900116 CONNECT-Z SWITCH

remote control; plastic, white  
Fernbedienung; Kunststoff, weiss  
Télécommande; plastique, blanc

L 80, B 80, H 7



CR2032



9 008606 285761

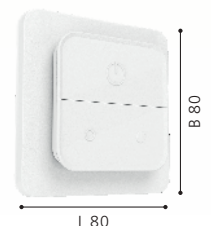

L 80

B 80



900878

LED





900879



## ANDREAS-Z

These luminaires allow the full range of functions through 2 control units. RGB and TW can be adjusted up and down. Both directions can be dimmed independently and the color or whites can be turned on and off together or separately.

Diese Leuchten ermöglichen den vollen Funktionsumfang durch 2 Steuerungseinheiten. RGB und TW können nach oben und unten eingestellt werden. Beide Richtungen können unabhängig voneinander gedimmt werden und die Farbe oder Weißtöne können gemeinsam oder getrennt ein- und ausgeschaltet werden.

Ces luminaires permettent de bénéficier de toutes les fonctionnalités grâce à 2 unités de commande. RGB et TW peuvent être réglés vers le haut et vers le bas. Les deux directions peuvent être atténuées indépendamment l'une de l'autre et les couleurs ou les blancs peuvent être allumés et éteints ensemble ou séparément.



### 900878 ANDREAS-Z

pendant light; steel, black / plastic, white  
Hängeleuchte; Stahl, schwarz / Kunststoff, weiss  
luminaire en suspension; acier, noir / plastique, blanc

L 1170, B 70, H 1100

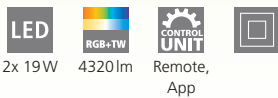

2x 19W 4320lm Remote, App

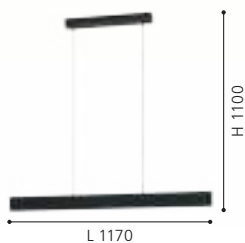

### 900879 ANDREAS-Z

pendant light; steel, grey / plastic, white  
Hängeleuchte; Stahl, grau / Kunststoff, weiss  
luminaire en suspension; acier, gris / plastique, blanc

L 1170, B 70, H 1100



2x 19W 4320lm Remote, App

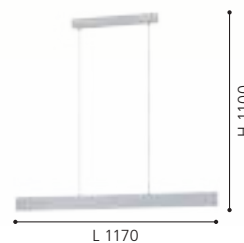



900387



900388



### 900387 ANCHORENA-Z

ceiling light; wood, steel, brown, black / plastic, white  
Deckenleuchte; Holz, Stahl, braun, schwarz / Kunststoff, weiss  
plafonnier; bois, acier, marron, noir / plastique, blanc

L 1230, B 80, H 110



35W



3980 lm



Remote,  
App



9 008606 243662



### 900388 ANCHORENA-Z

pendant light; wood, steel, brown, black / plastic, white  
Hängeleuchte; Holz, Stahl, braun, schwarz / Kunststoff, weiss  
luminaire en suspension; bois, acier, marron, noir / plastique, blanc

L 1230, B 55, H 1100



35W



3980 lm



Remote,  
App



9 008606 243679

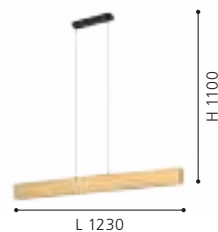

### 900391 ANCHORENA-Z

table light; wood, steel, brown, black / plastic, white  
Tischleuchte; Holz, Stahl, braun, schwarz / Kunststoff, weiss  
luminaire de table; bois, acier, marron, noir / plastique, blanc

L 75, B 55, H 465, Base: B 160, T 120



16W



1800 lm



Remote,  
App



9 008606 243693

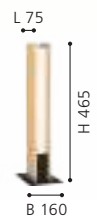



900391



### 900392 ANCHORENA-Z

floor light; wood, steel, brown, black / plastic, white  
 Stehleuchte; Holz, Stahl, braun, schwarz / Kunststoff, weiss  
 lampadaire; bois, acier, marron, noir / plastique, blanc

L 105, B 55, H 1500, Base: B 240, T 210



35W



3980lm



Remote,  
App



L 105

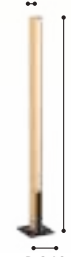

9 008606 243709



900392





900702

LED

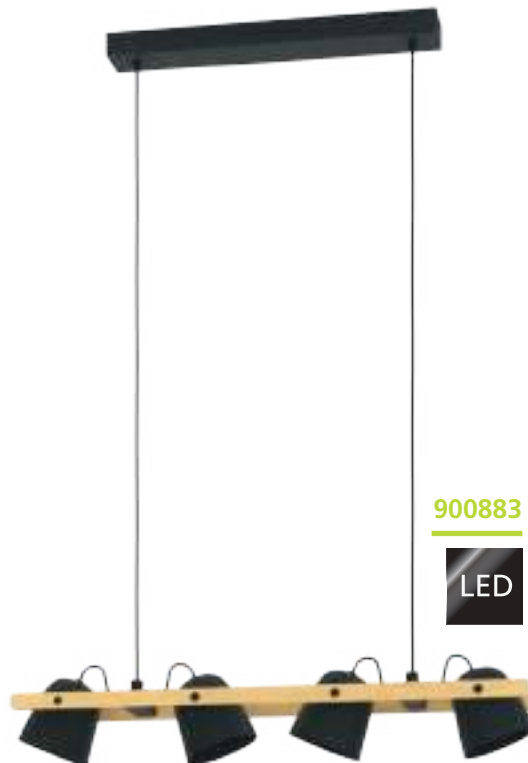

900883

LED



900882

LED



### 900702 KOKOMO-Z

pendant light; steel, wood, black, brown / aluminium, plastic, black, white

Hängeleuchte; Stahl, Holz, schwarz, braun / Alu, Kunststoff, schwarz, weiss

luminaire en suspension; acier, bois, noir, marron / aluminium, plastique, noir, blanc  
L 990, B 50, H 1100



34W



4100lm



Remote,  
App



9 008606 262090

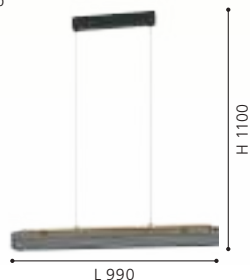

### 900883 HORNWOOD-Z

pendant light; steel, wood, black, brown

Hängeleuchte; Stahl, Holz, schwarz, braun

luminaire en suspension; acier, bois, noir, marron

L 780, B 140, H 1100



4x 3,7W



2000lm



Remote,  
App



9 008606 274291



### 900882 HORNWOOD-Z

ceiling light; steel, wood, black, brown

Deckenleuchte; Stahl, Holz, schwarz, braun

plafonnier; acier, bois, noir, marron

L 780, B 140, H 160



4x 3,7W



2000lm



Remote,  
App



9 008606 274284



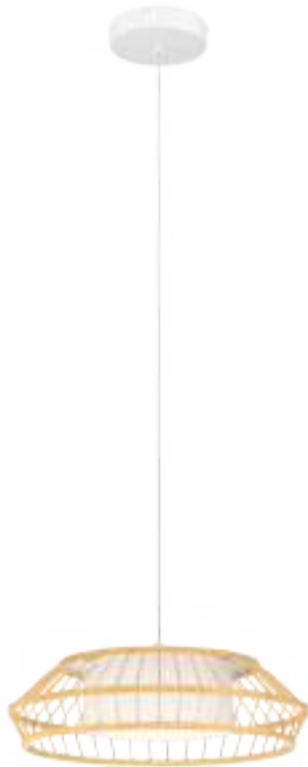

900842



LED

Ø 460



H 1100



9 008606 274055

H 1100, Ø 460

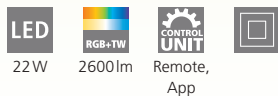

### 900842 YUKU-Z

pendant light; steel, white / wood, fabric, brown, white  
 Hängeleuchte; Stahl, weiss / Holz, Textil, braun, weiss  
 luminaire en suspension; acier, blanc / bois, tissu, marron, blanc

Ø 460



H 1100



9 008606 274055

H 1100, Ø 460



### 900842 YUKU-Z

pendant light; steel, white / wood, fabric, brown, white  
 Hängeleuchte; Stahl, weiss / Holz, Textil, braun, weiss  
 luminaire en suspension; acier, blanc / bois, tissu, marron, blanc

Ø 460



H 1100



9 008606 274055

H 1100, Ø 460

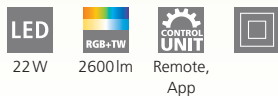

900842



LED

Ø 460



H 1100



9 008606 274055

H 1100, Ø 460



### 900842 YUKU-Z

pendant light; steel, white / wood, fabric, brown, white  
 Hängeleuchte; Stahl, weiss / Holz, Textil, braun, weiss  
 luminaire en suspension; acier, blanc / bois, tissu, marron, blanc

Ø 460

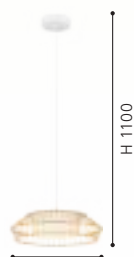

H 1100



9 008606 274055

H 1100, Ø 460



900841



LED

Ø 460



H 160



9 008606 274048

H 160, Ø 460



### 900841 YUKU-Z

ceiling light; steel, white / wood, fabric, brown, white  
 Deckenleuchte; Stahl, weiss / Holz, Textil, braun, weiss  
 plafonnier; acier, blanc / bois, tissu, marron, blanc

Ø 460



H 160



9 008606 274048

H 160, Ø 460



### 900841 YUKU-Z

ceiling light; steel, white / wood, fabric, brown, white  
 Deckenleuchte; Stahl, weiss / Holz, Textil, braun, weiss  
 plafonnier; acier, blanc / bois, tissu, marron, blanc

Ø 460



H 160



9 008606 274048

H 160, Ø 460



900881



LED



L 880

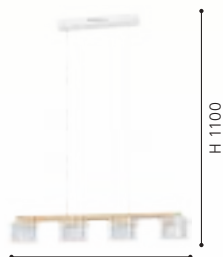

H 1100



9 008606 274604

L 880, B 150, H 1100



### 900881 PORTICO-Z

pendant light; steel, wood, white, brown / steel, glass, white, clear  
 Hängeleuchte; Stahl, Holz, weiss, braun / Stahl, Glas, weiss, klar  
 luminaire en suspension; acier, bois, blanc, marron / acier, verre, blanc, transparent

L 880

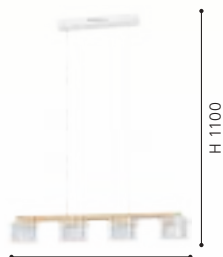

H 1100



9 008606 274604

L 880, B 150, H 1100



### 900881 PORTICO-Z

pendant light; steel, wood, white, brown / steel, glass, white, clear  
 Hängeleuchte; Stahl, Holz, weiss, braun / Stahl, Glas, weiss, klar  
 luminaire en suspension; acier, bois, blanc, marron / acier, verre, blanc, transparent



900853

LED



900855

LED

### 900853 BARBANO-Z

ceiling light; steel, black / fabric, plastic, black, white  
 Deckenleuchte; Stahl, schwarz / Textil, Kunststoff, schwarz, weiss  
 plafonnier; acier, noir / tissu, plastique, noir, blanc

L 605, B 565, H 90



3x 7,5W 2765lm Remote, App

### 900855 BARBANO-Z

ceiling light; steel, black / fabric, plastic, grey, white  
 Deckenleuchte; Stahl, schwarz / Textil, Kunststoff, grau, weiss  
 plafonnier; acier, noir / tissu, plastique, gris, blanc

L 605, B 565, H 90

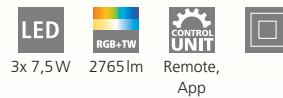

3x 7,5W 2765lm Remote, App





### 900854 BARBANO-Z

pendant light; steel, black / fabric, plastic, black, white  
 Hängeleuchte; Stahl, schwarz / Textil, Kunststoff, schwarz, weiss  
 luminaire en suspension; acier, noir / tissu, plastique, noir, blanc

L 820, B 300, H 1100

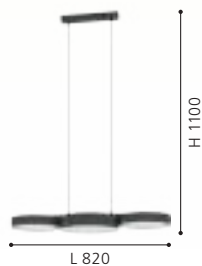
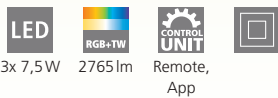

### 900856 BARBANO-Z

pendant light; steel, black / fabric, plastic, grey, white  
 Hängeleuchte; Stahl, schwarz / Textil, Kunststoff, grau, weiss  
 luminaire en suspension; acier, noir / tissu, plastique, gris, blanc

L 820, B 300, H 1100

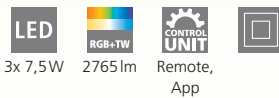



900439



900441



900442



### 900439 ROMAO-Z

ceiling light; steel, white / fabric, plastic, white  
Deckenleuchte; Stahl, weiss / Textil, Kunststoff, weiss  
plafonnier; acier, blanc / tissu, plastique, blanc

H 150, Ø 570



35W 3500lm Remote, App



9 008606 243914



### 900441 ROMAO-Z

ceiling light; steel, white / fabric, plastic, taupe, white  
Deckenleuchte; Stahl, weiss / Textil, Kunststoff, taupe, weiss  
plafonnier; acier, blanc / tissu, plastique, taupe, blanc

H 150, Ø 570

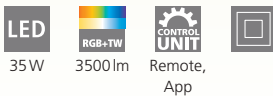

35W 3500lm Remote, App



9 008606 243921



### 900442 ROMAO-Z

ceiling light; steel, white / fabric linen, plastic, grey, white  
Deckenleuchte; Stahl, weiss / Textil Leinen, Kunststoff, grau, weiss  
plafonnier; acier, blanc / tissu de lin, plastique, gris, blanc

H 150, Ø 570



35W 3500lm Remote, App



9 008606 243938







900406

LED



900407

LED

### 900406 TOLLOS-Z

ceiling light; aluminium, steel, black, white / plastic, white  
Deckenleuchte; Alu, Stahl, schwarz, weiss / Kunststoff, weiss  
plafonnier; aluminium, acier, noir, blanc / plastique, blanc

H 130, Ø 400

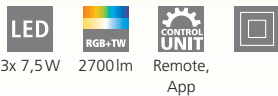

3x 7,5W 2700lm Remote, App

### 900407 TOLLOS-Z

ceiling light; aluminium, steel, black, white / plastic, white  
Deckenleuchte; Alu, Stahl, schwarz, weiss / Kunststoff, weiss  
plafonnier; aluminium, acier, noir, blanc / plastique, blanc

H 130, Ø 550

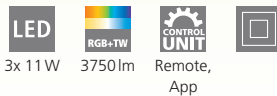

3x 11W 3750lm Remote, App



9 008606 243792



9 008606 243808





900723





900722

LED



900724

LED

### 900723 GINESTRONE-Z

pendant light; steel, black / plastic, white  
Hängeleuchte; Stahl, schwarz / Kunststoff, weiss  
luminaire en suspension; acier, noir / plastique, blanc

H 1100, Ø 450



22W 2450lm Remote, App



9 008606 270507



### 900722 GINESTRONE-Z

ceiling light; steel, black / plastic, white  
Deckenleuchte; Stahl, schwarz / Kunststoff, weiss  
plafonnier; acier, noir / plastique, blanc

H 220, Ø 450



22W 2450lm Remote, App



9 008606 270491



### 900724 GINESTRONE-Z

pendant light; steel, black / plastic, white  
Hängeleuchte; Stahl, schwarz / Kunststoff, weiss  
luminaire en suspension; acier, noir / plastique, blanc

L 900, B 200, H 1100

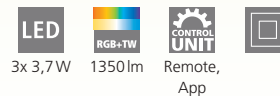

3x 3,7W 1350lm Remote, App



9 008606 274857

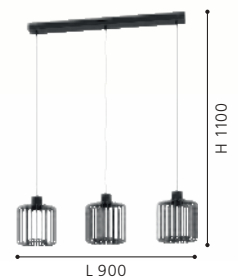



### 99679 SALVILANAS-Z

ceiling light; aluminium, steel, black / plastic, white  
 Deckenleuchte; Alu, Stahl, schwarz / Kunststoff, weiss  
 plafonnier; aluminium, acier, noir / plastique, blanc

L 770, B 200, H 75



21W 2700lm Remote, App



9 002759 996796



### 99678 SALVILANAS-Z

pendant light; aluminium, steel, black / plastic, white  
 Hängeleuchte; Alu, Stahl, schwarz / Kunststoff, weiss  
 luminaire en suspension; aluminium, acier, noir / plastique, blanc

L 770, B 200, H 1100



21W 2700lm Remote, App



9 002759 996789



### 99681 SALVILANAS-Z

pendant light; aluminium, steel, black / plastic, white  
 Hängeleuchte; Alu, Stahl, schwarz / Kunststoff, weiss  
 luminaire en suspension; aluminium, acier, noir / plastique, blanc

L 1160, B 200, H 1100



33W 4300lm Remote, App



9 002759 996819

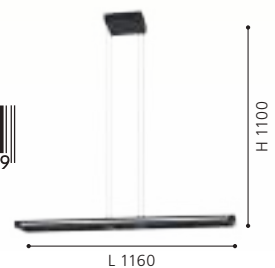



99682



99683



### 99682 SALVILANAS-Z

table light; aluminium, steel, black / plastic, white  
Tischleuchte; Alu, Stahl, schwarz / Kunststoff, weiss  
luminaire de table; aluminium, acier, noir / plastique, blanc

L 160, B 35, H 425, Base: B 240, T 160



9 002759 996826



### 99683 SALVILANAS-Z

floor light; aluminium, steel, black / plastic, white  
Stehleuchte; Alu, Stahl, schwarz / Kunststoff, weiss  
lampadaire; aluminium, acier, noir / plastique, blanc

L 200, B 35, H 1305, Base: B 280, T 180



9 002759 996833

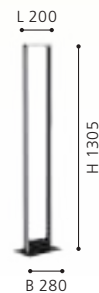

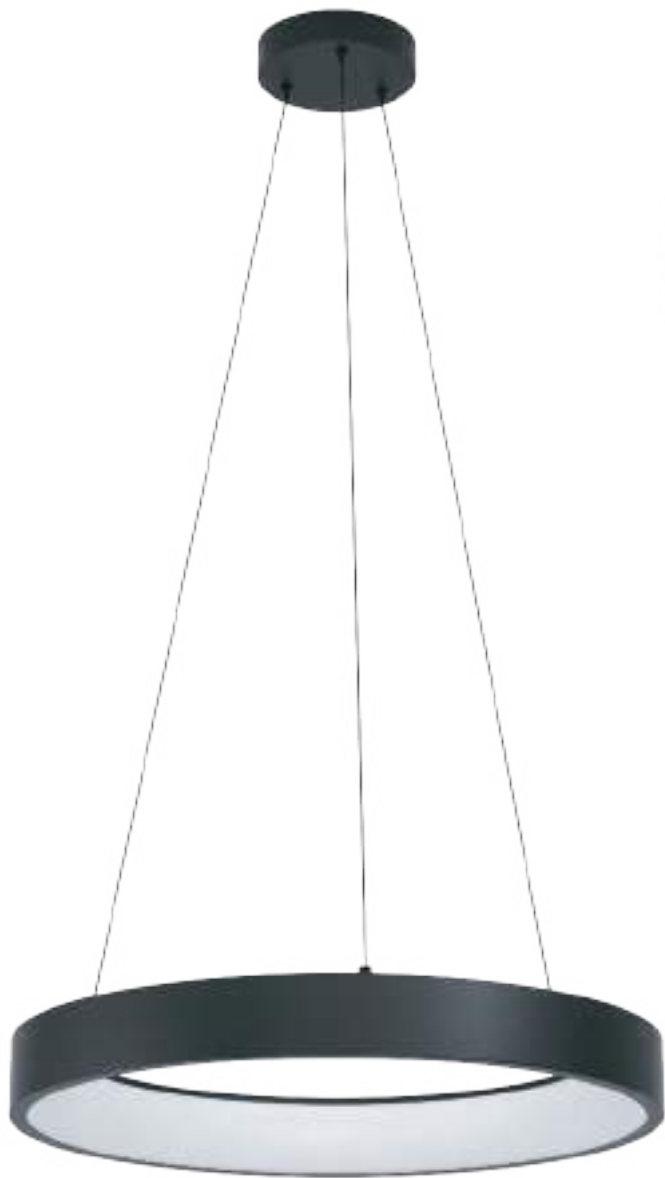

900068

LED



900067

LED



900069

LED

### 900068 MARGHERA-Z

pendant light; steel, black / plastic, white  
Hängeleuchte; Stahl, schwarz / Kunststoff, weiss  
luminaire en suspension; acier, noir / plastique, blanc

H 1100, Ø 600



4x 6,5W



3120lm



Remote,  
App



9 008606 222032



### 900067 MARGHERA-Z

ceiling light; steel, black / plastic, white  
Deckenleuchte; Stahl, schwarz / Kunststoff, weiss  
plafonnier; acier, noir / plastique, blanc

H 110, Ø 600



4x 6,5W



3120lm



Remote,  
App



9 008606 222025



### 900069 MARGHERA-Z

wall light; steel, black / plastic, white  
Wandleuchte; Stahl, schwarz / Kunststoff, weiss  
Applique; acier, noir / plastique, blanc

L 270, H 305, A 200



4x 4W



1800lm



Remote,  
App



9 008606 222049





900071



900072



### 900071 MARGHERA-Z

table light; steel, black / plastic, white  
Tischleuchte; Stahl, schwarz / Kunststoff, weiss  
luminaire de table; acier, noir / plastique, blanc

L 270, H 265, Base: Ø 145

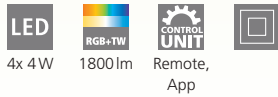

9 008606 222056



### 900072 MARGHERA-Z

floor light; steel, black / plastic, white  
Stehleuchte; Stahl, schwarz / Kunststoff, weiss  
lampadaire; acier, noir / plastique, blanc

L 270, B 305, H 1690, Base: Ø 305



9 008606 222063

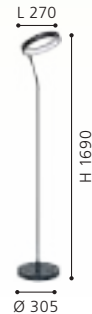



99603



99601



99602



### 99603 SIMOLARIS-Z

pendant light; aluminium, steel, black / plastic, white  
 Hängeleuchte; Alu, Stahl, schwarz / Kunststoff, weiss  
 luminaire en suspension; aluminium, acier, noir / plastique, blanc

L 1220, B 55, H 1100

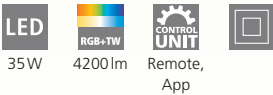

### 99601 SIMOLARIS-Z

ceiling light; aluminium, steel, black / plastic, white  
 Deckenleuchte; Alu, Stahl, schwarz / Kunststoff, weiss  
 plafonnier; aluminium, acier, noir / plastique, blanc

L 470, B 55, H 110

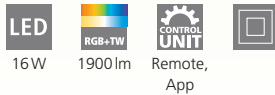

### 99602 SIMOLARIS-Z

ceiling light; aluminium, steel, black / plastic, white  
 Deckenleuchte; Alu, Stahl, schwarz / Kunststoff, weiss  
 plafonnier; aluminium, acier, noir / plastique, blanc

L 1220, B 55, H 110







99604



99605



### 99604 SIMOLARIS-Z

table light; aluminium, steel, black / plastic, white  
Tischleuchte; Alu, Stahl, schwarz / Kunststoff, weiss  
luminaire de table; aluminium, acier, noir / plastique, blanc

L 55, B 55, H 515, Base: B 160, T 120



### 99605 SIMOLARIS-Z

floor light; aluminium, steel, black / plastic, white  
Stehleuchte; Alu, Stahl, schwarz / Kunststoff, weiss  
lampadaire; aluminium, acier, noir / plastique, blanc

L 55, B 55, H 1615, Base: B 240, T 210

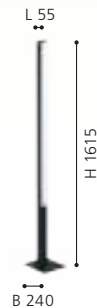



900079



900081



900082



### 900079 FRAIOLI-Z

ceiling light; aluminium, black / plastic, white  
Deckenleuchte; Alu, schwarz / Kunststoff, weiss  
plafonnier; aluminium, noir / plastique, blanc

L 1055, B 120, H 65



### 900081 FRAIOLI-Z

pendant light; aluminium, black / plastic, white  
Hängeleuchte; Alu, schwarz / Kunststoff, weiss  
luminaire en suspension; aluminium, noir / plastique, blanc

L 1055, B 100, H 1200



### 900082 FRAIOLI-Z

floor light; aluminium, black / plastic, white  
Stehleuchte; Alu, schwarz / Kunststoff, weiss  
lampadaire; aluminium, noir / plastique, blanc

H 1755, Base: B 280, T 280





900076



900077



900078



### 900076 FRAIOLI-Z

ceiling light; aluminium, satin nickel / plastic, white  
Deckenleuchte; Alu, nickel-matt / Kunststoff, weiss  
plafonnier; aluminium, nickel mat / plastique, blanc

L 1055, B 120, H 65

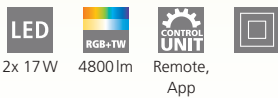

2x 17W 4800lm Remote, App



9 008606 223534



### 900077 FRAIOLI-Z

pendant light; aluminium, satin nickel / plastic, white  
Hängeleuchte; Alu, nickel-matt / Kunststoff, weiss  
luminaire en suspension; aluminium, nickel mat / plastique, blanc

L 1055, B 100, H 1200



2x 17W 4800lm Remote, App



9 008606 223541



### 900078 FRAIOLI-Z

floor light; aluminium, satin nickel / plastic, white  
Stehleuchte; Alu, nickel-matt / Kunststoff, weiss  
lampadaire; aluminium, nickel mat / plastique, blanc

H 1755, Base: B 280, T 280



2x 17W 4800lm Remote, App



9 008606 223558





900479

LED



900478

LED

### 900479 LOBINERO-Z

pendant light; aluminium, steel, black / plastic, white  
 Hängeleuchte; Alu, Stahl, schwarz / Kunststoff, weiss  
 luminaire en suspension; aluminium, acier, noir / plastique, blanc

H 1100, Ø 580



43,2W 6000lm Remote, App



9 008606 244157

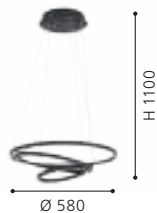

### 900478 LOBINERO-Z

pendant light; aluminium, steel, white / plastic, white  
 Hängeleuchte; Alu, Stahl, weiss / Kunststoff, weiss  
 luminaire en suspension; aluminium, acier, blanc / plastique, blanc

H 1100, Ø 580



43,2W 6000lm Remote, App



9 008606 244140

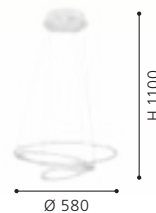

### 900398 ZILLERIO-Z

pendant light; steel, aluminium, black / plastic, white  
 Hängeleuchte; Stahl, Alu, schwarz / Kunststoff, weiss  
 luminaire en suspension; acier, aluminium, noir / plastique, blanc

L 1160, B 300, H 1100

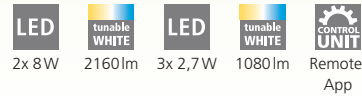

2x 8W 2160lm 3x 2,7W 1080lm Remote, App



9 008606 240593

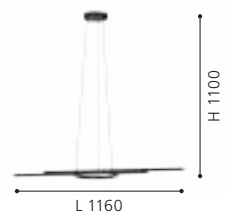



900398

LED

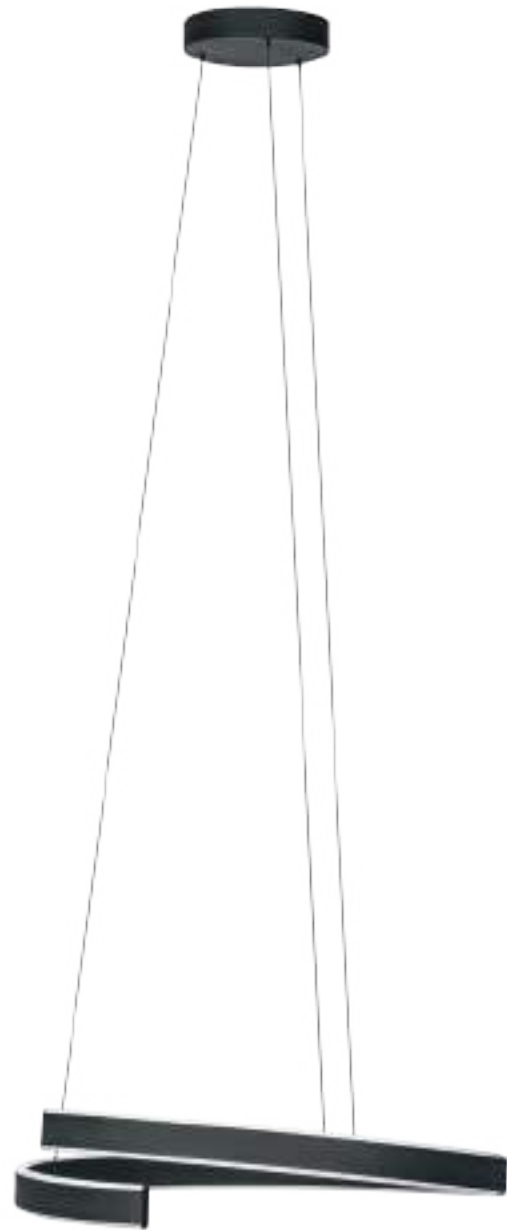

900404

LED

### 900404 ANDABAIA-Z

pendant light; aluminium, steel, black / plastic, white  
 Hängeleuchte; Alu, Stahl, schwarz / Kunststoff, weiss  
 luminaire en suspension; aluminium, acier, noir / plastique, blanc

H 1540, Ø 600

LED

42,5W

tunable  
WHITE

5300lm

CONTROL  
UNIT

Remote,  
App

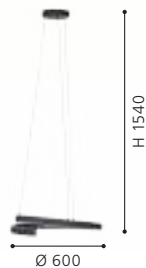



900019



IP44



900021



IP44

### 900019 TABIANO-Z

mirror light; steel, chrome / plastic, white  
 Spiegelleuchte; Stahl, chrom / Kunststoff, weiss  
 applique pour miroir; acier, chrome / plastique, blanc

L 605, H 70, A 135



15,6W



1950lm



Remote,  
App



IP44



### 900021 TABIANO-Z

mirror light; steel, chrome / plastic, white  
 Spiegelleuchte; Stahl, chrom / Kunststoff, weiss  
 applique pour miroir; acier, chrome / plastique, blanc

L 905, H 70, A 135



21,5W



2750lm



Remote,  
App



IP44



9 008606 221646



9 008606 221653





99676

LED



99677

LED



### 99676 LOMALTAS-Z

ceiling light; steel, wood, black, brown / plastic, white  
Deckenleuchte; Stahl, Holz, schwarz, braun / Kunststoff, weiss  
plafonnier; acier, bois, noir, marron / plastique, blanc

L 580, B 350



### 99677 LOMALTAS-Z

ceiling light; steel, wood, black, brown / plastic, white  
Deckenleuchte; Stahl, Holz, schwarz, braun / Kunststoff, weiss  
plafonnier; acier, bois, noir, marron / plastique, blanc

L 770, B 495, H 85

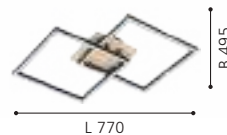



900315



900317



900316



### 900315 PARANDAY-Z

ceiling light; steel, black / plastic, white  
Deckenleuchte; Stahl, schwarz / Kunststoff, weiss  
plafonnier; acier, noir / plastique, blanc

L 470, B 225, H 60



15,5W 1800lm Remote, App

### 900316 PARANDAY-Z

ceiling light; steel, black / plastic, white  
Deckenleuchte; Stahl, schwarz / Kunststoff, weiss  
plafonnier; acier, noir / plastique, blanc

L 525, B 310, H 60



21,5W 2500lm Remote, App

### 900317 PARANDAY-Z

ceiling light; steel, black / plastic, white  
Deckenleuchte; Stahl, schwarz / Kunststoff, weiss  
plafonnier; acier, noir / plastique, blanc

L 650, B 310, H 60



32,4W 4000lm Remote, App



9 008606 231195

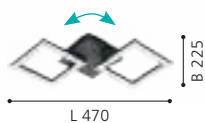

9 008606 231201



9 008606 231218

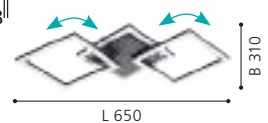





**900318 PARANDAY-Z**

ceiling light; steel, black / plastic, white  
Deckenleuchte; Stahl, schwarz / Kunststoff, weiss  
plafonnier; acier, noir / plastique, blanc

L 470, B 430, H 65



42 W



5000 lm



Remote,  
App



9 008606 231225



900318





900322



900323



900324



### 900322 PARRAPOS-Z

ceiling light; steel, black / plastic, white  
Deckenleuchte; Stahl, schwarz / Kunststoff, weiss  
plafonnier; acier, noir / plastique, blanc

L 445, B 300, H 70

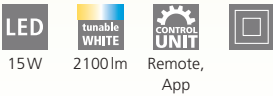

### 900323 PARRAPOS-Z

ceiling light; steel, black / plastic, white  
Deckenleuchte; Stahl, schwarz / Kunststoff, weiss  
plafonnier; acier, noir / plastique, blanc

L 340, B 300, H 45



### 900324 PARRAPOS-Z

wall light; steel, black / plastic, white  
Wandleuchte; Stahl, schwarz / Kunststoff, weiss  
Applique; acier, noir / plastique, blanc

L 200, H 240, A 50





900319

LED



900321

LED



### 900319 PARRAPOS-Z

ceiling light; steel, black / plastic, white  
Deckenleuchte; Stahl, schwarz / Kunststoff, weiss  
plafonnier; acier, noir / plastique, blanc

L 615, B 450, H 80



### 900321 PARRAPOS-Z

ceiling light; steel, black / plastic, white  
Deckenleuchte; Stahl, schwarz / Kunststoff, weiss  
plafonnier; acier, noir / plastique, blanc

L 545, B 445, H 90

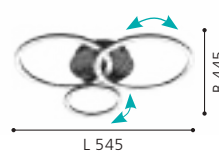
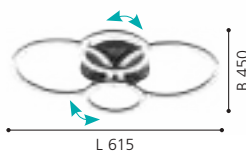

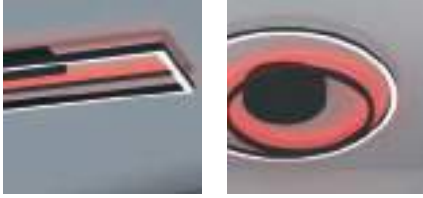

## CALAGRANO-Z

These lights have individually controllable light settings on the inside and outside of the frame.

Diese Leuchten verfügen über individuell steuerbare Lichteinstellungen der Rahmen innen und außen.

Ces lumières ont des paramètres d'éclairage contrôlables individuellement du cadre.



900729



900728



900567



### 900728 CALAGRANO-Z

ceiling light; aluminium, steel, black / plastic, white  
Deckenleuchte; Alu, Stahl, schwarz / Kunststoff, weiss  
plafonnier; aluminium, acier, noir / plastique, blanc

H 35, Ø 450



21,5W



2700lm



Remote,  
App



9 008606 262229



### 900729 CALAGRANO-Z

ceiling light; aluminium, steel, black / plastic, white  
Deckenleuchte; Alu, Stahl, schwarz / Kunststoff, weiss  
plafonnier; aluminium, acier, noir / plastique, blanc

L 450, B 450, H 50



21W



2900lm



Remote,  
App



9 008606 262236

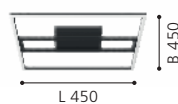

### 900567 CALAGRANO-Z

ceiling light; aluminium, steel, black / plastic, white  
Deckenleuchte; Alu, Stahl, schwarz / Kunststoff, weiss  
plafonnier; aluminium, acier, noir / plastique, blanc

L 640, B 220, H 50



21W



2600lm



Remote,  
App



9 008606 244690

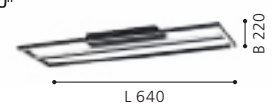



### 900566 CALAGRANO-Z

ceiling light; aluminium, steel, black / plastic, white  
Deckenleuchte; Alu, Stahl, schwarz / Kunststoff, weiss  
plafonnier; aluminium, acier, noir / plastique, blanc

L 640, B 240, H 45



21 W



2600 lm



Remote,  
App



9 008606 244683

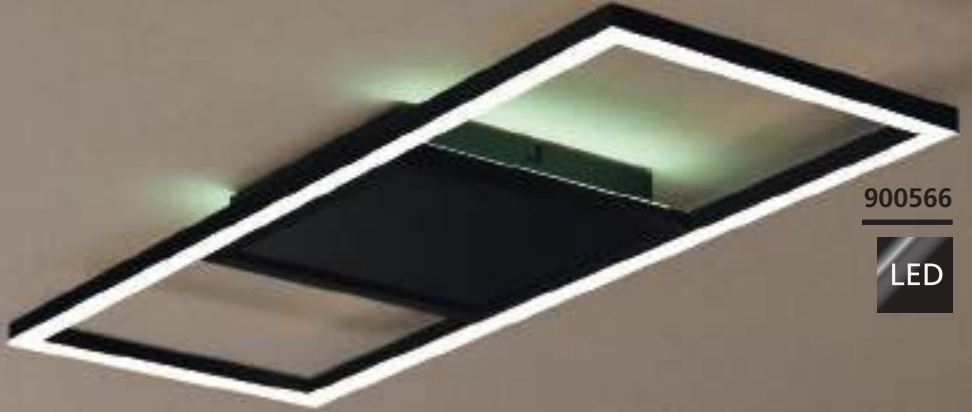

900566

LED



900408



900409



### 900408 MONTEMORELOS-Z

ceiling light; aluminium, white / plastic with crystal effect, white  
Deckenleuchte; Alu, weiss / Kunststoff m. Kristalleffekt, weiss  
plafonnier; aluminium, blanc / plastique avec effet cristal, blanc

H 50, Ø 420



17,8W



2150lm



Remote,  
App



### 900409 MONTEMORELOS-Z

ceiling light; aluminium, white / plastic with crystal effect, white  
Deckenleuchte; Alu, weiss / Kunststoff m. Kristalleffekt, weiss  
plafonnier; aluminium, blanc / plastique avec effet cristal, blanc

H 70, Ø 570



34,5W



4100lm



Remote,  
App



9 008606 243815



9 008606 243822





900411



900412

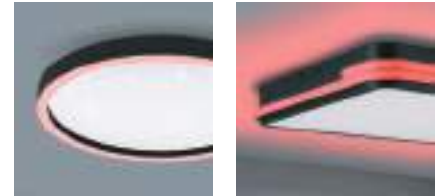

### MONTEMORELOS-Z, GENOVESE-Z

The frame of these luminaires can switch between the RGB colors, the inner part can reproduce different white tones between 2700K and 6500K. By controlling via app or remote control, individual lighting effects can be set.

Der Rahmen dieser Leuchten kann zwischen den RGB Farbtönen wechseln, der Innenteil kann verschiedene Weißtöne zwischen 2700K und 6500K wiedergeben. Durch Steuerung per App oder Fernbedienung können so individuelle Lichtspiele eingestellt werden.

Le cadre de cette luminaires peut basculer entre les couleurs RVB, la partie intérieure peut reproduire différents tons blancs entre 2700K et 6500K. En contrôlant via l'application ou la télécommande, des effets d'éclairage individuels peuvent être définis.



900477



### 900411 MONTEMORELOS-Z

ceiling light; aluminium, black / plastic with crystal effect, white  
Deckenleuchte; Alu, schwarz / Kunststoff m. Kristalleffekt, weiss  
plafonnier; aluminium, noir / plastique avec effet cristal, blanc

H 50, Ø 420

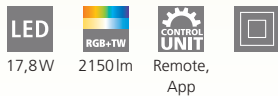

17,8W 2150lm Remote, App

### 900412 MONTEMORELOS-Z

ceiling light; aluminium, black / plastic with crystal effect, white  
Deckenleuchte; Alu, schwarz / Kunststoff m. Kristalleffekt, weiss  
plafonnier; aluminium, noir / plastique avec effet cristal, blanc

H 70, Ø 570



34,5W 4100lm Remote, App

### 900477 GENOVESE-Z

ceiling light; aluminium, steel, black / plastic, white  
Deckenleuchte; Alu, Stahl, schwarz / Kunststoff, weiss  
plafonnier; aluminium, acier, noir / plastique, blanc

L 470, B 470, H 70



22W 3000lm Remote, App



9 008606 243839



9 008606 243846



9 008606 252763





900088

LED



900086

LED



900089

LED



### ROVITO-Z

These lights have individually controllable light settings on the inside and outside of the frame.

Diese Leuchten verfügen über individuell steuerbare Lichtstellungen der Rahmen innen und außen.

Ces lumières ont des paramètres d'éclairage contrôlables individuellement du cadre.

### 900088 ROVITO-Z

ceiling light; plastic, white / plastic, white  
Deckenleuchte; Kunststoff, weiss / Kunststoff, weiss  
plafonnier; plastique, blanc / plastique, blanc

L 295, B 295, H 25

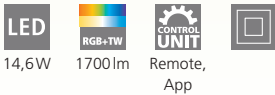

14,6W 1700lm Remote, App



### 900089 ROVITO-Z

ceiling light; plastic, white / plastic, white  
Deckenleuchte; Kunststoff, weiss / Kunststoff, weiss  
plafonnier; plastique, blanc / plastique, blanc

L 420, B 420, H 25

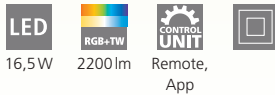

16,5W 2200lm Remote, App



### 900086 ROVITO-Z

ceiling light; plastic, white / plastic, white  
Deckenleuchte; Kunststoff, weiss / Kunststoff, weiss  
plafonnier; plastique, blanc / plastique, blanc

H 25, Ø 295

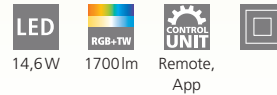

14,6W 1700lm Remote, App







900087

LED

### 900087 ROVITO-Z

ceiling light; plastic, white / plastic, white

Deckenleuchte; Kunststoff, weiss / Kunststoff, weiss

plafonnier; plastique, blanc / plastique, blanc

H 25, Ø 420

LED

16,5W

RGB+TW

2200lm

CONTROL  
UNIT

Remote,  
App



9 008606 225484





900093



900092



900094



### 900093 ROVITO-Z

ceiling light; plastic, black / plastic, white  
Deckenleuchte; Kunststoff, schwarz / Kunststoff, weiss  
plafonnier; plastique, noir / plastique, blanc

L 295, B 295, H 25



14,6W



1700lm



Remote,  
App



### 900094 ROVITO-Z

ceiling light; plastic, black / plastic, white  
Deckenleuchte; Kunststoff, schwarz / Kunststoff, weiss  
plafonnier; plastique, noir / plastique, blanc

L 420, B 420, H 25



16,5W



2200lm



Remote,  
App



### 900092 ROVITO-Z

ceiling light; plastic, black / plastic, white  
Deckenleuchte; Kunststoff, schwarz / Kunststoff, weiss  
plafonnier; plastique, noir / plastique, blanc

H 25, Ø 420



16,5W



2200lm



Remote,  
App



9 008606 225538



9 008606 225545



9 008606 225521





## ROVITO-Z

These lights have individually controllable light settings on the inside and outside of the frame.

Diese Leuchten verfügen über individuell steuerbare Lichteinstellungen der Rahmen innen und außen.

Ces lumières ont des paramètres d'éclairage contrôlables individuellement du cadre.

### 900091 ROVITO-Z

ceiling light; plastic, black / plastic, white

Deckenleuchte; Kunststoff, schwarz / Kunststoff, weiss

plafonnier; plastique, noir / plastique, blanc

H 25, Ø 295



14,6W



1700lm



Remote,  
App



9 008606 225514

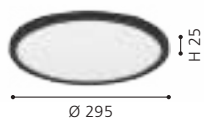

900091

LED



900481



900484



900483



### 900481 PADROGIANO-Z

ceiling light; steel, white / plastic, white  
Deckenleuchte; Stahl, weiss / Kunststoff, weiss  
plafonnier; acier, blanc / plastique, blanc

L 450, B 450, H 50

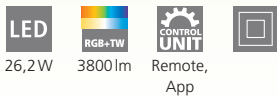

26,2W 3800lm Remote, App



9 008606 244164



### 900483 PADROGIANO-Z

ceiling light; steel, white / plastic, white  
Deckenleuchte; Stahl, weiss / Kunststoff, weiss  
plafonnier; acier, blanc / plastique, blanc

L 450, B 450, H 50

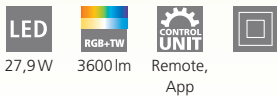

27,9W 3600lm Remote, App



9 008606 244188



### 900484 PADROGIANO-Z

ceiling light; steel, white / plastic, white  
Deckenleuchte; Stahl, weiss / Kunststoff, weiss  
plafonnier; acier, blanc / plastique, blanc

L 595, B 595, H 50



35,5W 4800lm Remote, App



9 008606 244195





900486

LED



### PADROGIANO-Z

These lights have individually controllable light settings on the inside and outside of the frame.

Diese Leuchten verfügen über individuell steuerbare Lichteinstellungen der Rahmen innen und außen.

Ces lumières ont des paramètres d'éclairage contrôlables individuellement du cadre.



900487

LED



### 900486 PADROGIANO-Z

ceiling light; steel, white / plastic, white  
Deckenleuchte; Stahl, weiss / Kunststoff, weiss  
plafonnier; acier, blanc / plastique, blanc

H 50, Ø 450



26,5W

3300lm

Remote,  
App



9 008606 244218



Ø 450

### 900487 PADROGIANO-Z

ceiling light; steel, white / plastic, white  
Deckenleuchte; Stahl, weiss / Kunststoff, weiss  
plafonnier; acier, blanc / plastique, blanc

H 50, Ø 595



35W

4600lm

Remote,  
App



9 008606 244225



Ø 595





900482

LED



## PADROGIANO-Z

The frame of these luminaires can switch between the RGB colors, the inner part can reproduce different white tones between 2700K and 6500K. By controlling via app or remote control, individual lighting effects can be set.

Der Rahmen dieser Leuchten kann zwischen den RGB Farbtönen wechseln, der Innenteil kann verschiedene Weißtöne zwischen 2700K und 6500K wiedergeben. Durch Steuerung per App oder Fernbedienung können so individuelle Lichtspiele eingestellt werden.

Le cadre de cette luminaires peut basculer entre les couleurs RVB, la partie intérieure peut reproduire différents tons blancs entre 2700K et 6500K. En contrôlant via l'application ou la télécommande, des effets d'éclairage individuels peuvent être définis.



### 900482 PADROGIANO-Z

ceiling light; steel, white / plastic, white  
Deckenleuchte; Stahl, weiss / Kunststoff, weiss  
plafonnier; acier, blanc / plastique, blanc

L 1200, B 300, H 50



42,5 W 6000 lm Remote, App



9 008606 244171

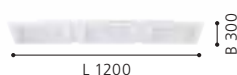

### 900485 PADROGIANO-Z

ceiling light; steel, white / plastic, white  
Deckenleuchte; Stahl, weiss / Kunststoff, weiss  
plafonnier; acier, blanc / plastique, blanc

L 1200, B 300, H 50



43,2 W 6000 lm Remote, App



9 008606 244201

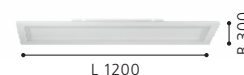

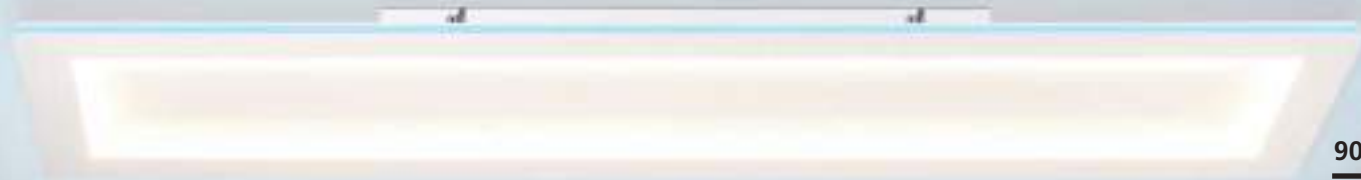

900485

LED





900025



### SAVATARILA-Z

One frame of the luminaires is rotatable.  
 Ein Rahmen der Leuchten ist drehbar.  
 Un cadre de les luminaires est rotatif.

### 900025 SAVATARILA-Z

ceiling light; steel, black / plastic, white  
 Deckenleuchte; Stahl, schwarz / Kunststoff, weiss  
 plafonnier; acier, noir / plastique, blanc

L 450, B 450, H 70



4x 2,7W



1320lm



4x 2,7W



1280lm



Remote,  
App

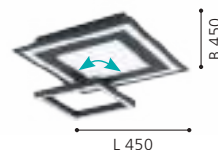





900022



900024



900023



### 900023 SAVATARILA-Z

ceiling light; steel, white / plastic, white  
Deckenleuchte; Stahl, weiss / Kunststoff, weiss  
plafonnier; acier, blanc / plastique, blanc

L 450, B 450, H 70



9 008606 221677

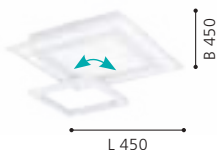

### 900022 SALITERAS-Z

ceiling light; steel, white / plastic, white  
Deckenleuchte; Stahl, weiss / Kunststoff, weiss  
plafonnier; acier, blanc / plastique, blanc

L 1160, B 160, H 50



9 008606 221660



### 900024 SALITERAS-Z

ceiling light; steel, black / plastic, white  
Deckenleuchte; Stahl, schwarz / Kunststoff, weiss  
plafonnier; acier, noir / plastique, blanc

L 1160, B 160, H 50



9 008606 221684





900054



900056



### TURCONA-Z

Frameless luminaires

Rahmenlose Leuchten

Luminaire sans cadre



#### 900054 TURCONA-Z

ceiling light; steel, aluminium, white / plastic, white  
Deckenleuchte; Stahl, Alu, weiss / Kunststoff, weiss  
plafonnier; acier, aluminium, blanc / plastique, blanc

H 60, Ø 300

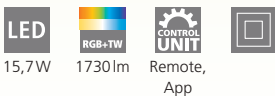

15,7W

1730lm

Remote,  
App

#### 900056 TURCONA-Z

ceiling light; steel, aluminium, white / plastic, white  
Deckenleuchte; Stahl, Alu, weiss / Kunststoff, weiss  
plafonnier; acier, aluminium, blanc / plastique, blanc

H 75, Ø 600



34,2W

3980lm

Remote,  
App

#### 900055 TURCONA-Z

ceiling light; steel, aluminium, white / plastic, white  
Deckenleuchte; Stahl, Alu, weiss / Kunststoff, weiss  
plafonnier; acier, aluminium, blanc / plastique, blanc

H 75, Ø 450



22,4W

2490lm

Remote,  
App



9 008606 221905



9 008606 221929

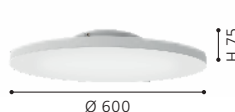

9 008606 221912





900055

LED

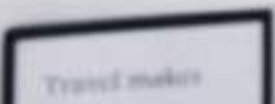



900057



900058



900059



### TURCONA-Z

Frameless luminaires

Rahmenlose Leuchten

Luminaires sans cadre

#### 900057 TURCONA-Z

ceiling light; steel, aluminium, white / plastic, white  
Deckenleuchte; Stahl, Alu, weiss / Kunststoff, weiss  
plafonnier; acier, aluminium, blanc / plastique, blanc

L 300, B 300, H 50



16W



1750lm



Remote,  
App



#### 900058 TURCONA-Z

ceiling light; steel, aluminium, white / plastic, white  
Deckenleuchte; Stahl, Alu, weiss / Kunststoff, weiss  
plafonnier; acier, aluminium, blanc / plastique, blanc

L 450, B 450, H 70



6x 3,8W



2400lm



Remote,  
App



#### 900059 TURCONA-Z

ceiling light; steel, aluminium, white / plastic, white  
Deckenleuchte; Stahl, Alu, weiss / Kunststoff, weiss  
plafonnier; acier, aluminium, blanc / plastique, blanc

L 600, B 600, H 75



6x 5,4W



4000lm



Remote,  
App



9 008606 221936

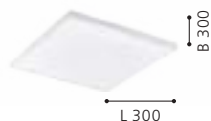

9 008606 221943

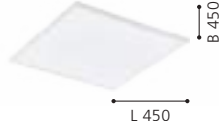

9 008606 221950

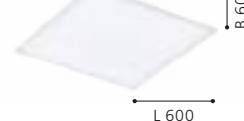



900062



900061



**900062 TURCONA-Z**

ceiling light; steel, aluminium, white / plastic, white  
 Deckenleuchte; Stahl, Alu, weiss / Kunststoff, weiss  
 plafonnier; acier, aluminium, blanc / plastique, blanc

L 1200, B 100, H 75

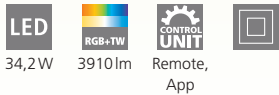

34,2W 3910lm Remote, App

**900061 TURCONA-Z**

ceiling light; steel, aluminium, white / plastic, white  
 Deckenleuchte; Stahl, Alu, weiss / Kunststoff, weiss  
 plafonnier; acier, aluminium, blanc / plastique, blanc

L 1200, B 300, H 75

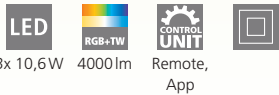

3x 10,6W 4000lm Remote, App



9 008606 221974

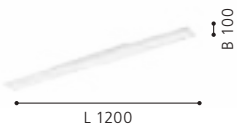

9 008606 221967

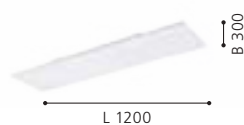



900762



### 900762 SARSINA-Z

ceiling light; aluminium, steel, black / plastic, white  
Deckenleuchte; Alu, Stahl, schwarz / Kunststoff, weiss  
plafonnier; aluminium, acier, noir / plastique, blanc

H 52, Ø 600



41 W



5800lm



Remote,  
App



9 008606 264070

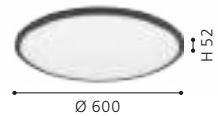



900759



900761



900758



### 900761 SARSINA-Z

ceiling light; aluminium, steel, black / plastic, white  
Deckenleuchte; Alu, Stahl, schwarz / Kunststoff, weiss  
plafonnier; aluminium, acier, noir / plastique, blanc

H 52, Ø 450

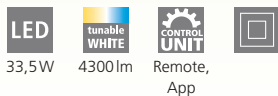

9 008606 264063



### 900759 SARSINA-Z

ceiling light; aluminium, steel, white / plastic, white  
Deckenleuchte; Alu, Stahl, weiss / Kunststoff, weiss  
plafonnier; aluminium, acier, blanc / plastique, blanc

H 52, Ø 600



9 008606 264056



### 900758 SARSINA-Z

ceiling light; aluminium, steel, white / plastic, white  
Deckenleuchte; Alu, Stahl, weiss / Kunststoff, weiss  
plafonnier; aluminium, acier, blanc / plastique, blanc

H 52, Ø 450

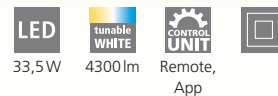

9 008606 264049





900044



900045



900046



### 900044 SALOBRENA-Z

ceiling light; aluminium, white / plastic, white  
Deckenleuchte; Alu, weiss / Kunststoff, weiss  
plafonnier; aluminium, blanc / plastique, blanc

L 300, B 300, H 50

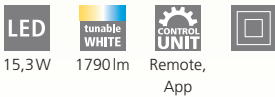

15,3W 1790lm Remote, App



9 008606 221813

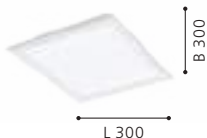

### 900045 SALOBRENA-Z

ceiling light; aluminium, white / plastic, white  
Deckenleuchte; Alu, weiss / Kunststoff, weiss  
plafonnier; aluminium, blanc / plastique, blanc

L 450, B 450, H 50



21,5W 2500lm Remote, App



9 008606 221820

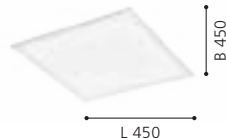

### 900046 SALOBRENA-Z

ceiling light; aluminium, white / plastic, white  
Deckenleuchte; Alu, weiss / Kunststoff, weiss  
plafonnier; aluminium, blanc / plastique, blanc

L 595, B 595, H 50

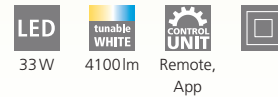

33W 4100lm Remote, App



9 008606 221837

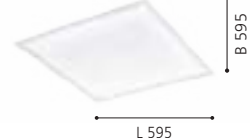





900047

LED



900048

LED



### 900047 SALOBRENA-Z

ceiling light; aluminium, white / plastic, white  
Deckenleuchte; Alu, weiss / Kunststoff, weiss  
plafonnier; aluminium, blanc / plastique, blanc

L 1200, B 300, H 50



### 900048 SALOBRENA-Z

ceiling light; aluminium, white / plastic, white  
Deckenleuchte; Alu, weiss / Kunststoff, weiss  
plafonnier; aluminium, blanc / plastique, blanc

L 1200, B 100, H 45

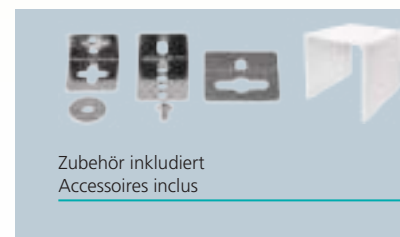
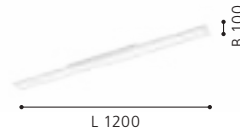
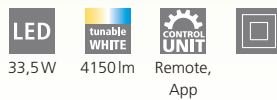

Zubehör inkludiert  
Accessoires inclus



900049



900051



900052



### 900049 SALOBRENA-Z

ceiling light; aluminium, black / plastic, white  
Deckenleuchte; Alu, schwarz / Kunststoff, weiss  
plafonnier; aluminium, noir / plastique, blanc

L 300, B 300, H 50

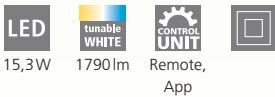

15,3W 1790lm Remote, App



9 008606 221868

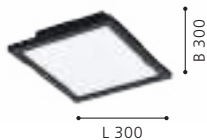

### 900051 SALOBRENA-Z

ceiling light; aluminium, black / plastic, white  
Deckenleuchte; Alu, schwarz / Kunststoff, weiss  
plafonnier; aluminium, noir / plastique, blanc

L 450, B 450, H 50



21,5W 2500lm Remote, App



9 008606 221875

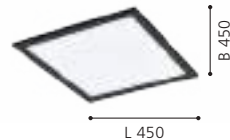

### 900052 SALOBRENA-Z

ceiling light; aluminium, black / plastic, white  
Deckenleuchte; Alu, schwarz / Kunststoff, weiss  
plafonnier; aluminium, noir / plastique, blanc

L 595, B 595, H 50

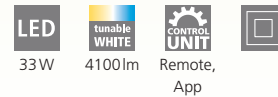

33W 4100lm Remote, App



9 008606 221882





900053

LED



900095

LED



### 900053 SALOBRENA-Z

ceiling light; aluminium, black / plastic, white  
 Deckenleuchte; Alu, schwarz / Kunststoff, weiss  
 plafonnier; aluminium, noir / plastique, blanc

L 1200, B 300, H 50

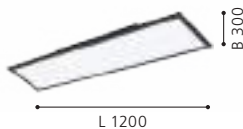

### 900095 SALOBRENA-Z

ceiling light; aluminium, steel, black / plastic, white  
 Deckenleuchte; Alu, Stahl, schwarz / Kunststoff, weiss  
 plafonnier; aluminium, acier, noir / plastique, blanc

L 1200, B 100, H 45

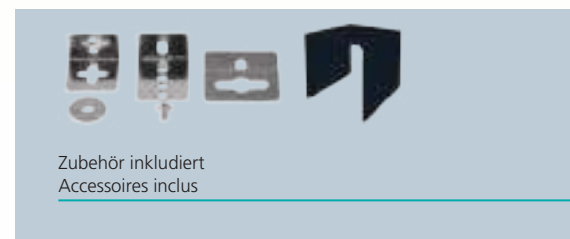
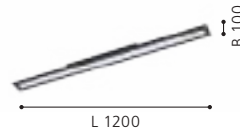
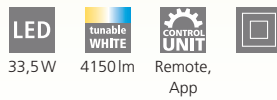

Zubehör inkludiert  
 Accessoires inclus



99548



99549



### 99548 HERRORA-Z

ceiling light; aluminium, white / plastic, white  
Deckenleuchte; Alu, weiss / Kunststoff, weiss  
plafonnier; aluminium, blanc / plastique, blanc

L 595, B 595, H 40

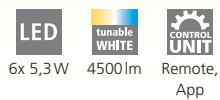

6x 5,3W 4500lm Remote, App



9 002759 995485



### 99549 HERRORA-Z

ceiling light; aluminium, white / plastic, white  
Deckenleuchte; Alu, weiss / Kunststoff, weiss  
plafonnier; aluminium, blanc / plastique, blanc

L 1200, B 300, H 40



3x 10,5W 4500lm Remote, App



9 002759 995492



### 99639 HERRORA-Z

ceiling light; aluminium, white / plastic, white  
Deckenleuchte; Alu, weiss / Kunststoff, weiss  
plafonnier; aluminium, blanc / plastique, blanc

L 450, B 450, H 40



22W 2900lm Remote, App



9 002759 996390

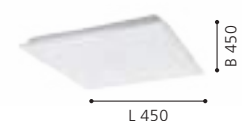



99639

LED





900099



IP20/44



900101



IP20/44

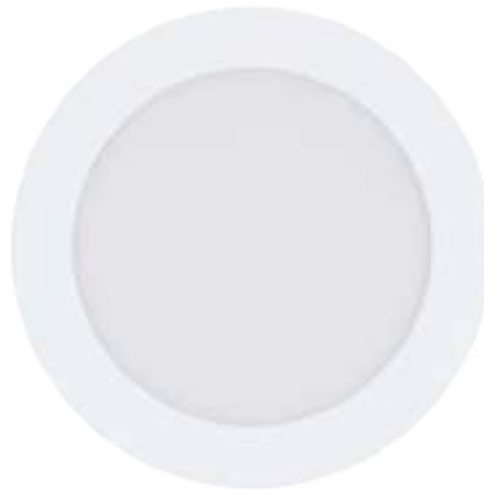

900102



IP20/44



### 900099 FUEVA-Z

recessed light; steel, white / plastic, white  
Einbauleuchte; Stahl, weiss / Kunststoff, weiss  
luminaire encastrable; acier, blanc / plastique, blanc

H 26, Ø 85



3x 2,8W



3x 390lm



Remote,  
App



Ø 75



IP20/44



Ø 85

### 900101 FUEVA-Z

recessed light; steel, white / plastic, white  
Einbauleuchte; Stahl, weiss / Kunststoff, weiss  
luminaire encastrable; acier, blanc / plastique, blanc

H 26, Ø 120



5,4W



800lm



Remote,  
App



Ø 105



IP20/44



Ø 120

### 900102 FUEVA-Z

recessed light; steel, white / plastic, white  
Einbauleuchte; Stahl, weiss / Kunststoff, weiss  
luminaire encastrable; acier, blanc / plastique, blanc

H 26, Ø 165



10,5W



1520lm



Remote,  
App



Ø 155



IP20/44



Ø 165



98842

LED



IP20/44

### 98842 FUEVA-Z

recessed light; aluminium, white / plastic, white  
Einbauleuchte; Alu, weiss / Kunststoff, weiss  
luminaire encastrable; aluminium, blanc / plastique, blanc

Ø 216, ET 26



16,5W



2100lm



Remote,  
App



Ø 205



IP20/44



9 002759 988425



Ø 216



900112



IP20/44

900111



IP20/44



900113



IP20/44



### 900111 FUEVA-Z

recessed light; steel, satin nickel / plastic, white  
Einbauleuchte; Stahl, nickel-matt / Kunststoff, weiss  
luminaire encastrable; acier, nickel mat / plastique, blanc

H 26, Ø 85



3x 2,8W



3x 390lm



Remote, App



Ø 75



IP20/44



9 008606 225668



Ø 85

### 900112 FUEVA-Z

recessed light; steel, satin nickel / plastic, white  
Einbauleuchte; Stahl, nickel-matt / Kunststoff, weiss  
luminaire encastrable; acier, nickel mat / plastique, blanc

H 26, Ø 120



5,4W



800lm



Remote, App



Ø 105



IP20/44



9 008606 225675



Ø 120

### 900113 FUEVA-Z

recessed light; steel, satin nickel / plastic, white  
Einbauleuchte; Stahl, nickel-matt / Kunststoff, weiss  
luminaire encastrable; acier, nickel mat / plastique, blanc

H 26, Ø 165



10,5W



1520lm



Remote, App



Ø 155



IP20/44



9 008606 225682



Ø 165





98844



IP20/44

**98844 FUEVA-Z**

recessed light; aluminium, satin nickel / plastic, white  
 Einbauleuchte; Alu, nickel-matt / Kunststoff, weiss  
 luminaire encastrable; aluminium, nickel mat / plastique, blanc

Ø 216, ET 26



16,5W



2100lm



Remote,  
App



Ø 205



IP20/44



9 002759 988449



Ø 216



900105



IP20/44



900106



IP20/44



98846



IP20/44



### 900105 FUEVA-Z

recessed light; steel, black / plastic, white  
Einbauleuchte; Stahl, schwarz / Kunststoff, weiss  
luminaire encastrable; acier, noir / plastique, blanc

H 26, Ø 85



3x 2,8W



3x 390lm



Remote,  
App



Ø 75



IP20/44



9 008606 225613



Ø 85

### 900106 FUEVA-Z

recessed light; steel, black / plastic, white  
Einbauleuchte; Stahl, schwarz / Kunststoff, weiss  
luminaire encastrable; acier, noir / plastique, blanc

H 26, Ø 120



5,4W



800lm



Remote,  
App



Ø 105



IP20/44



9 008606 225620



Ø 120

### 98846 FUEVA-Z

recessed light; aluminium, black / plastic, white  
Einbauleuchte; Alu, schwarz / Kunststoff, weiss  
luminaire encastrable; aluminium, noir / plastique, blanc

Ø 216, ET 26



16,5W



2100lm



Remote,  
App



Ø 205



IP20/44



9 002759 988463



Ø 216



900107



IP20/44

## 900107 FUEVA-Z

recessed light; steel, black / plastic, white

Einbauleuchte; Stahl, schwarz / Kunststoff, weiss

luminaire encastrable; acier, noir / plastique, blanc

H 26, Ø 165



10,5W



1520lm



Remote,  
App



Ø 155



IP20/44



9 008606 225637



Ø 165



900104



IP44



900103



IP44



98849



IP44

### 900104 FUEVA-Z

surface-mounted light; steel, white / plastic, white  
Aufbauleuchte; Stahl, weiss / Kunststoff, weiss  
luminaire en saillie; acier, blanc / plastique, blanc

L 210, B 210, H 28



16,5W



2250lm



Remote,  
App



IP44



### 98849 FUEVA-Z

surface-mounted light; aluminium, white / plastic, white  
Aufbauleuchte; Alu, weiss / Kunststoff, weiss  
luminaire en saillie; aluminium, blanc / plastique, blanc

L 285, B 285, H 28



19,5W



2500lm



Remote,  
App



IP44



### 900103 FUEVA-Z

surface-mounted light; steel, white / plastic, white  
Aufbauleuchte; Stahl, weiss / Kunststoff, weiss  
luminaire en saillie; acier, blanc / plastique, blanc

H 28, Ø 210



16,5W



2250lm



Remote,  
App



IP44



9 008606 225606



L 210



9 002759 988494



L 285



9 008606 225590



Ø 210



### 98843 FUEVA-Z

surface-mounted light; aluminium, white / plastic, white  
Aufbauleuchte; Alu, weiss / Kunststoff, weiss  
luminaire en saillie; aluminium, blanc / plastique, blanc

H 28, Ø 285

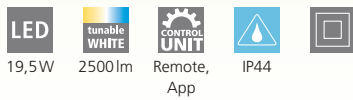

LED

19,5W

tunable  
WHITE

2500lm

CONTROL  
UNIT

Remote,  
App

IP44





900114



IP44



900115



IP44



98845



IP44

### 900114 FUEVA-Z

surface-mounted light; steel, satin nickel / plastic, white  
Aufbauleuchte; Stahl, nickel-matt / Kunststoff, weiss  
luminaire en saillie; acier, nickel mat / plastique, blanc

H 28, Ø 210



16,5W



2250lm



Remote,  
App



IP44



### 98845 FUEVA-Z

surface-mounted light; aluminium, satin nickel / plastic, white  
Aufbauleuchte; Alu, nickel-matt / Kunststoff, weiss  
luminaire en saillie; aluminium, nickel mat / plastique, blanc

H 28, Ø 285



19,5W



2500lm



Remote,  
App



IP44



### 900115 FUEVA-Z

surface-mounted light; steel, satin nickel / plastic, white  
Aufbauleuchte; Stahl, nickel-matt / Kunststoff, weiss  
luminaire en saillie; acier, nickel mat / plastique, blanc

L 210, B 210, H 28



16,5W



2250lm



Remote,  
App



IP44



9 008606 225699



9 002759 988456



9 008606 225705

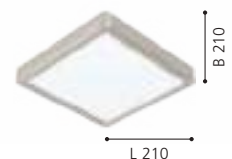



### 98852 FUEVA-Z

surface-mounted light; aluminium, satin nickel / plastic, white  
Aufbauleuchte; Alu, nickel-matt / Kunststoff, weiss  
luminaire en saillie; aluminium, nickel mat / plastique, blanc

L 285, B 285, H 28

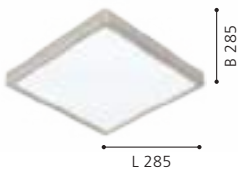
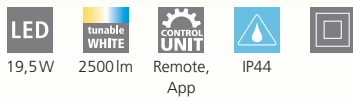

98852



IP44



900108



IP44



98854



IP44



98847



IP44

### 900108 FUEVA-Z

surface-mounted light; steel, black / plastic, white  
Aufbauleuchte; Stahl, schwarz / Kunststoff, weiss  
luminaire en saillie; acier, noir / plastique, blanc

H 28, Ø 210



16,5W



2250 lm



Remote,  
App



IP44



9 008606 225644



Ø 210

### 98847 FUEVA-Z

surface-mounted light; aluminium, black / plastic, white  
Aufbauleuchte; Alu, schwarz / Kunststoff, weiss  
luminaire en saillie; aluminium, noir / plastique, blanc

H 28, Ø 285



19,5W



2500 lm



Remote,  
App



IP44



9 002759 988470



Ø 285

### 98854 FUEVA-Z

surface-mounted light; aluminium, black / plastic, white  
Aufbauleuchte; Alu, schwarz / Kunststoff, weiss  
luminaire en saillie; aluminium, noir / plastique, blanc

L 285, B 285, H 28



19,5W



2500 lm



Remote,  
App



IP44



9 002759 988548



L 285





### 900109 FUEVA-Z

surface-mounted light; steel, black / plastic, white  
Aufbauleuchte; Stahl, schwarz / Kunststoff, weiss  
luminaire en saillie; acier, noir / plastique, blanc

L 210, B 210, H 28

16,5W	2250lm	Remote, App	IP44	

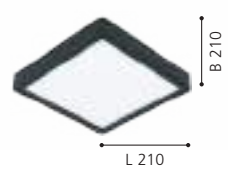

900109



IP44



900001



900002



900636



IP44

### 900001 TOTARI-Z

ceiling light; steel, white / plastic with crystal effect, white  
Deckenleuchte; Stahl, weiss / Kunststoff m. Kristalleffekt, weiss  
plafonnier; acier, blanc / plastique avec effet cristal, blanc

H 70, Ø 380



4x 4,8W



2160lm



Remote,  
App



### 900002 TOTARI-Z

ceiling light; steel, white / plastic with crystal effect, white  
Deckenleuchte; Stahl, weiss / Kunststoff m. Kristalleffekt, weiss  
plafonnier; acier, blanc / plastique avec effet cristal, blanc

H 70, Ø 530



4x 11,2W



4960lm



Remote,  
App



### 900636 TOTARI-Z

ceiling light; steel, white / plastic with crystal effect, white  
Deckenleuchte; Stahl, weiss / Kunststoff m. Kristalleffekt, weiss  
plafonnier; acier, blanc / plastique avec effet cristal, blanc

H 70, Ø 380



4x 4,8W



2160lm



Remote,  
App



IP44



9 008606 221479



9 008606 221486



9 008606 245208





900084

LED



900085

LED

### 900084 TOTARI-Z

ceiling light; steel, white / plastic, white  
Deckenleuchte; Stahl, weiss / Kunststoff, weiss  
plafonnier; acier, blanc / plastique, blanc

H 70, Ø 380



4x 4,8W 2160lm Remote, App



9 008606 225453



### 900085 TOTARI-Z

ceiling light; steel, white / plastic, white  
Deckenleuchte; Stahl, weiss / Kunststoff, weiss  
plafonnier; acier, blanc / plastique, blanc

H 70, Ø 530



4x 11,2W 4960lm Remote, App



9 008606 225460





900083



900005



900006



### 900083 LANCIANO-Z

ceiling light; steel, white, transparent / plastic with crystal effect, white, chrome

Deckenleuchte; Stahl, weiss, transparent / Kunststoff m.Kristalleffekt, weiss, chrom

plafonnier; acier, blanc, transparent / plastique avec effet cristal, blanc, chrome  
H 80, Ø 450



4x 4,8W



2160lm



Remote,  
App



### 900005 LANCIANO-Z

ceiling light; steel, white, transparent / plastic with crystal effect, white, chrome

Deckenleuchte; Stahl, weiss, transparent / Kunststoff m.Kristalleffekt, weiss, chrom

plafonnier; acier, blanc, transparent / plastique avec effet cristal, blanc, chrome  
H 80, Ø 560



4x 11,2W



4960lm



Remote,  
App



### 900006 LANCIANO-Z

ceiling light; steel, white, transparent / plastic with crystal effect, white, chrome

Deckenleuchte; Stahl, weiss, transparent / Kunststoff m.Kristalleffekt, weiss, chrom

plafonnier; acier, blanc, transparent / plastique avec effet cristal, blanc, chrome  
H 95, Ø 770



38,1W



5350lm



Remote,  
App



9 008606 225446



9 008606 221516



9 008606 221523





900128

LED



900129

LED

### 900128 SILERAS-Z

ceiling light; steel, white / plastic with crystal effect, white  
Deckenleuchte; Stahl, weiss / Kunststoff m.Kristalleffekt, weiss  
plafonnier; acier, blanc / plastique avec effet cristal, blanc

H 60, Ø 430



3x 7,2 W



2700 lm



Remote,  
App



### 900129 SILERAS-Z

ceiling light; steel, white / plastic with crystal effect, white  
Deckenleuchte; Stahl, weiss / Kunststoff m.Kristalleffekt, weiss  
plafonnier; acier, blanc / plastique avec effet cristal, blanc

H 60, Ø 600



3x 11 W



4050 lm



Remote,  
App



9 008606 226054



9 008606 226061





900336

LED



900337

LED



900338

LED



DIMMABLE  
VIA REMOTE  
AND APP

### 900336 TELIMBELA-Z

spot; steel, black  
Spot; Stahl, schwarz  
spot; acier, noir

H 97, Ø 250

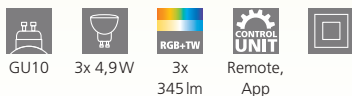

GU10 3x 4,9W 3x 345lm Remote, App

### 900337 TELIMBELA-Z

spot; steel, black  
Spot; Stahl, schwarz  
spot; acier, noir

L 580, B 80, H 97

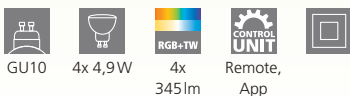

GU10 4x 4,9W 4x 345lm Remote, App

### 900338 TELIMBELA-Z

spot; steel, white  
Spot; Stahl, weiss  
spot; acier, blanc

H 97, Ø 250

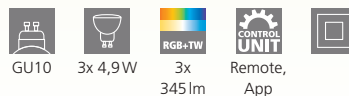

GU10 3x 4,9W 3x 345lm Remote, App



9 008606 239948



9 008606 239955



9 008606 239962





900339

LED

### 900339 TELIMBELA-Z

spot; steel, white  
Spot; Stahl, weiss  
spot; acier, blanc

L 580, B 80, H 97



GU10



4x 4,9W



4x  
345 lm



Remote,  
App



9 008606 239979





99673

LED



99674

LED



99675

LED



### 99673 CAMINALES-Z

ceiling light; steel, black  
Deckenleuchte; Stahl, schwarz  
plafonnier; acier, noir

L 125, B 125, H 120



GU10



1x 4,9W



1x  
345lm



Remote,  
App



### 99674 CAMINALES-Z

ceiling light; steel, black  
Deckenleuchte; Stahl, schwarz  
plafonnier; acier, noir

L 240, B 125, H 120



GU10



2x 4,9W



2x  
345lm



Remote,  
App



### 99675 CAMINALES-Z

ceiling light; steel, black  
Deckenleuchte; Stahl, schwarz  
plafonnier; acier, noir

L 240, B 240, H 120



GU10



4x 4,9W



4x  
345lm



Remote,  
App







99669



99671



99672



### 99669 SALICETO-Z

recessed light; aluminium, black  
 Einbauleuchte; Alu, schwarz  
 luminaire encastrable; aluminium, noir

H 46, Ø 88, ET 50

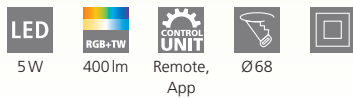

### 99671 SALICETO-Z

recessed light; aluminium, white  
 Einbauleuchte; Alu, weiss  
 luminaire encastrable; aluminium, blanc

H 46, Ø 88, ET 50

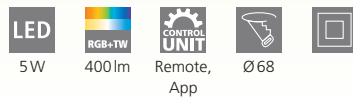

### 99672 SALICETO-Z

recessed light; aluminium, satin nickel  
 Einbauleuchte; Alu, nickel-matt  
 luminaire encastrable; aluminium, nickel mat

H 46, Ø 88, ET 50

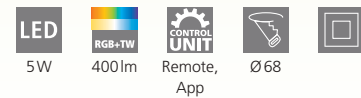



900763

LED



900765

LED

### 900763 CAROSSO-Z

recessed light; aluminium, black / plastic, white  
 Einbauleuchte; Alu, schwarz / Kunststoff, weiss  
 luminaire encastrable; aluminium, noir / plastique, blanc

L 93, B 93, H 25

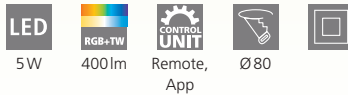

### 900765 CAROSSO-Z

recessed light; aluminium, white / plastic, white  
 Einbauleuchte; Alu, weiss / Kunststoff, weiss  
 luminaire encastrable; aluminium, blanc / plastique, blanc

L 93, B 93, H 25

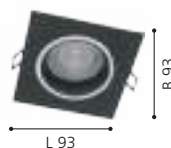
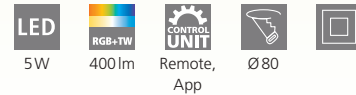



900766



900764



### 900766 CAROSSO-Z

recessed light; aluminium, white / plastic, white  
 Einbauleuchte; Alu, weiss / Kunststoff, weiss  
 luminaire encastrable; aluminium, blanc / plastique, blanc

H 28, Ø 93

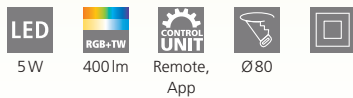

### 900764 CAROSSO-Z

recessed light; aluminium, black / plastic, white  
 Einbauleuchte; Alu, schwarz / Kunststoff, weiss  
 luminaire encastrable; aluminium, noir / plastique, blanc

H 28, Ø 93

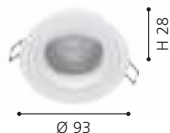
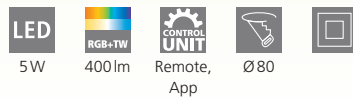

### 99684

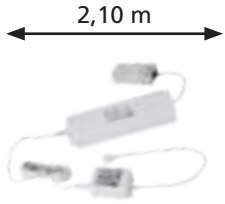

2,10 m

Driver included  
Treiber inkludiert  
Chauffeur inclus



### 99684



### 99685

Extension for starter set 99684 without driver  
Erweiterung für Starterset 99684 ohne Treiber  
Rallonge pour kit de démarrage 99684 sans pilote



### 99685



### 99684 LED STRIPE-Z

bar/strip light; plastic, white  
Leuchtband/-stab; Kunststoff, weiss  
bande lumineuse / bâton l; plastique, blanc

L 3000, B 8



13,5W 1450lm Remote, App

### 99685 LED STRIPE-Z

bar/strip light; plastic, white  
Leuchtband/-stab; Kunststoff, weiss  
bande lumineuse / bâton l; plastique, blanc

L 2000, B 8



9W 950lm Remote, App

DIMMABLE  
VIA REMOTE  
AND APP



9 002759 996840



L 3000



9 002759 996857



L 2000

99686

1,50 m



Driver included  
Treiber inkludiert  
Chauffeur inclus



99686

LED

99687

3,40 m



Driver included  
Treiber inkludiert  
Chauffeur inclus



99687

LED



### 99686 LED STRIPE-Z

bar/strip light; plastic, white  
Leuchtband/-stab; Kunststoff, weiss  
bande lumineuse / bâton l; plastique, blanc

L 5000, B 12



11W



1250lm



Remote,  
App



9 002759 996864



L 5000

### 99687 LED STRIPE-Z

bar/strip light; plastic, white  
Leuchtband/-stab; Kunststoff, weiss  
bande lumineuse / bâton l; plastique, blanc

L 8000, B 12



8x 3W



2640lm



Remote,  
App



9 002759 996871



L 8000



## EGLO CONNECT.Z ILLUMINANT

One illuminant – numerous possibilities: 16.7 million colours and over 50,000 white tones ensure the right atmosphere in your home at all times. The illuminant can be controlled via remote control or app using Bluetooth technology: You can control the brightness or adjust colour tones – and all this without complicated installation and comfortably from the sofa.

But the illuminant can do much more: it can be expanded at will using intelligent mesh technology, and up to 50 illuminants can be grouped together. This makes it easy to create and program a wide variety of lighting scenarios. You can also use the app to select from a large number of pre-set lighting scenes.

Security is not neglected either, as the illuminants form a self-contained network and are therefore protected from external access.

## EGLO CONNECT.Z LEUCHTMITTEL

Ein Leuchtmittel – zahlreiche Möglichkeiten: 16,7 Millionen Farben und über 50.000 Weißtöne sorgen jederzeit für die richtige Stimmung in Ihrem Heim. Über die Bluetooth-Technologie kann das Leuchtmittel per Fernbedienung oder App gesteuert werden: Sie können die Helligkeit kontrollieren oder Farbtöne einstellen – und das alles ohne aufwändige Installation und bequem vom Sofa aus.

Aber das Leuchtmittel kann noch viel mehr: es lässt sich per intelligenter Mesh-Technologie beliebig erweitern, bis zu 50 Leuchtmittel sind hierbei gruppierbar. So lassen sich problemlos und einfach unterschiedlichste Lichtszenarien erstellen und programmieren. Mit der App können Sie aber auch aus einer Vielzahl vorgegebener Lichtstimmungen auswählen.

Auch die Sicherheit kommt nicht zu kurz, denn die Leuchtmittel bilden ein in sich geschlossenes Netzwerk und sind somit vor Zugriffen von Außen geschützt.

## AMPOULE EGLO CONNECT.Z











Une seule ampoule – de nombreuses possibilités : 16,7 millions de couleurs et plus de 50 000 tons de blanc assurent à tout moment la bonne ambiance dans votre maison. L'ampoule peut être commandée via une télécommande ou une appli, utilisant la technologie Bluetooth : Vous pouvez contrôler la luminosité ou régler les tons de couleurs – et tout cela sans installation compliquée et de manière confortablement depuis votre canapé.

Mais l'ampoule peut faire beaucoup plus : elle peut être étendue à volonté grâce à la technologie Mesh intelligentes, et jusqu'à 50 ampoules peuvent être regroupées. Il est ainsi facile de créer et de programmer une grande variété de scène lumineuse. Vous pouvez également utiliser l'appli pour sélectionner un grand nombre d'ambiance lumineuse prédéfinies.

La sécurité n'est pas négligée non plus, car les ampoules forment un réseau fermé et sont donc protégées des accès externes.



### 12253 E27-LED-A60

 <b>806 lm</b>	 <b>RGB+TW</b>	<b>2700-6500 K</b>	 <b>A++ F</b>
 L 118, Ø 60	 dimmable via remote & app	 9 W	 15000 h
 220-240V, 50/60Hz	 9 W ~ 60 W	 E27	 80 CRI





## 12254 E27-LED-G95



1300 lm



2700-6500 K



L 142, Ø 95



dimmable via remote & app



13.5 W



15000 h



220-240V,50/60Hz



13.5 W ~ 88 W



E27



80 CRI



## 12252 E14-LED-P45



470 lm



2700-6500 K



L 92, Ø 45



dimmable via remote & app



4.9 W



15000 h



220-240V,50/60Hz



4.9 W ~ 35 W



E14



80 CRI



## 12251 GU10-LED



345 lm



2700-6500 K



L 59, Ø 50



dimmable via remote & app

45°



4.9 W



15000 h



220-240V,50/60Hz



4.9 W ~ 50 W



GU10



83 CRI



## 12226 E27-LED-A60



<b>806 lm</b>	<b>warm WHITE</b> <b>2700 K</b>	<b>E</b>
L 105, Ø 60	dimmable via remote & app	
6 W	15000 h	
220-240V, 50/60Hz	6 W ~ 60 W	
E27	80 CRI	



## 12227 E27-LED-ST64



<b>806 lm</b>	<b>warm WHITE</b> <b>2700 K</b>	<b>E</b>
L 142, Ø 64	dimmable via remote & app	
6 W	15000 h	
220-240V, 50/60Hz	6 W ~ 60 W	
E27	80 CRI	



## 12228 E27-LED-G80



<b>806 lm</b>	<b>warm WHITE</b> <b>2700 K</b>	<b>E</b>
L 120, Ø 80	dimmable via remote & app	
6 W	15000 h	
220-240V, 50/60Hz	6 W ~ 60 W	
E27	80 CRI	







### 12229 E27-LED-G95

<b>806 lm</b>	<b>warm WHITE</b>	<b>2700 K</b>	
---------------	-------------------	---------------	--

L 140, Ø 95	dimmable via remote & app
6 W	15000 h
220-240V,50/60Hz	6 W ~ 60 W
E27	80 CRI



### 12231 E27-LED-A60

<b>806 lm</b>	<b>neutral WHITE</b>	<b>4000 K</b>	
---------------	----------------------	---------------	--

L 105, Ø 60	dimmable via remote & app
6 W	15000 h
220-240V,50/60Hz	6 W ~ 60 W
E27	80 CRI



### 12232 E27-LED-ST64

<b>806 lm</b>	<b>neutral WHITE</b>	<b>4000 K</b>	
---------------	----------------------	---------------	--

L 142, Ø 64	dimmable via remote & app
6 W	15000 h
220-240V,50/60Hz	6 W ~ 60 W
E27	80 CRI



## 12233 E27-LED-G80



<b>806 lm</b>	<b>neutral WHITE</b>	<b>4000 K</b>	<b>E</b>
L 120, Ø 80	dimmable via remote & app		
6 W	15000 h		
220-240V, 50/60Hz	6 W ~ 60 W		
E27	80 CRI		



## 12234 E27-LED-G95



<b>806 lm</b>	<b>neutral WHITE</b>	<b>4000 K</b>	<b>E</b>
L 140, Ø 95	dimmable via remote & app		
6 W	15000 h		
220-240V, 50/60Hz	6 W ~ 60 W		
E27	80 CRI		



## 12235 E27-LED-A60



<b>806 lm</b>	<b>tunable WHITE</b>	<b>2200-6500 K</b>	<b>E</b>
L 105, Ø 60	dimmable via remote & app		
6 W	15000 h		
220-240V, 50/60Hz	6 W ~ 60 W		
E27	80 CRI		





### 12236 E27-LED-ST64

<b>806 lm</b>	<b>tunable WHITE</b>	<b>2200-6500 K</b>	
---------------	----------------------	--------------------	--

L 142, Ø 64	dimmable via remote & app
6 W	15000 h
220-240V,50/60Hz	6 W ~ 60 W
E27	80 CRI



### 12237 E27-LED-G80

<b>806 lm</b>	<b>tunable WHITE</b>	<b>2200-6500 K</b>	
---------------	----------------------	--------------------	--

L 120, Ø 80	dimmable via remote & app
6 W	15000 h
220-240V,50/60Hz	6 W ~ 60 W
E27	80 CRI



### 12239 E27-LED-G95

<b>806 lm</b>	<b>tunable WHITE</b>	<b>2200-6500 K</b>	
---------------	----------------------	--------------------	--

L 140, Ø 95	dimmable via remote & app
6 W	15000 h
220-240V,50/60Hz	6 W ~ 60 W
E27	80 CRI



## 12221 E27-LED-A60



<b>500 lm</b>	<b>warm WHITE</b>	<b>2200 K</b>	<b>F</b>
L 105, Ø 60	dimmable via remote & app		
4.9 W	15000 h		
220-240V, 50/60Hz	4.9 W ~ 42 W		
E27	80 CRI		



## 12222 E27-LED-ST64



<b>500 lm</b>	<b>warm WHITE</b>	<b>2200 K</b>	<b>F</b>
L 142, Ø 64	dimmable via remote & app		
4.9 W	15000 h		
220-240V, 50/60Hz	4.9 W ~ 42 W		
E27	80 CRI		



## 12223 E27-LED-G80



<b>500 lm</b>	<b>warm WHITE</b>	<b>2200 K</b>	<b>F</b>
L 120, Ø 80	dimmable via remote & app		
4.9 W	15000 h		
220-240V, 50/60Hz	4.9 W ~ 42 W		
E27	80 CRI		





## 12224 E27-LED-G95



500 lm

warm  
WHITE

2200 K



L 140, Ø 95



dimmable via  
remote & app



4.9 W



15000 h



220-240V,50/60Hz



4.9 W ~ 42 W



E27



80 CRI



## 12225 E27-LED-G125



650 lm

warm  
WHITE

2200 K



L 172, Ø 125



dimmable via  
remote & app



6 W



15000 h



220-240V,50/60Hz



6 W ~ 51 W



E27











80 CRI



## 12241 E27-LED-A60



 **360 lm**  **2200-6500 K** 









 L 105, Ø 60	 dimmable via remote & app
 4.9 W	 15000 h
 220-240V, 50/60Hz	 4.9 W ~ 33 W
 E27	 80 CRI



## 12242 E27-LED-ST64



 **360 lm**  **2200-6500 K** 









 L 142, Ø 64	 dimmable via remote & app
 4.9 W	 15000 h
 220-240V, 50/60Hz	 4.9 W ~ 33 W
 E27	 80 CRI



## 12243 E27-LED-G80



 **360 lm**  **2200-6500 K** 

 L 120, Ø 80	 dimmable via remote & app
 4.9 W	 15000 h
 220-240V, 50/60Hz	 4.9 W ~ 33 W
 E27	 80 CRI



## 12244 E27-LED-G95



 **360 lm**

 tunable  
WHITE

**2200-6500 K**



 L 140, Ø 95

 dimmable via  
remote & app

 4.9 W

 15000 h

 220-240V,50/60Hz

 4.9 W ~ 33 W

 E27

 80 CRI



## 12245 E27-LED-G125



 **360 lm**

 tunable  
WHITE

**2200-6500 K**





 L 170, Ø 125

 dimmable via  
remote & app

 4.9 W

 15000 h

 220-240V,50/60Hz

 4.9 W ~ 33 W

 E27

 80 CRI



WARM WHITE



COLD WHITE

## 12255 E27-LED-A60



<b>806 lm</b>	<b>neutral WHITE</b>	<b>4000 K</b>	<b>E</b>
L 105, Ø 60	dimmable via remote & app	2 x AAA Battery included	
6 W	15000 h		
220-240V, 50/60Hz	6 W ~ 60 W		
E27	80 CRI		



## 12256 E27-LED-ST64



<b>500 lm</b>	<b>warm WHITE</b>	<b>2200 K</b>	<b>F</b>
L 142, Ø 64	dimmable via remote & app	2 x AAA Battery included	
4.9 W	15000 h		
220-240V, 50/60Hz	4.9 W ~ 42 W		
E27	80 CRI		



## 12257 E27-LED-A60



<b>806 lm</b>	<b>neutral WHITE</b>	<b>4000 K</b>	<b>E</b>
L 105, Ø 60	dimmable via remote & app	3 x AA Battery included	
6 W	15000 h		
220-240V, 50/60Hz	6 W ~ 60 W		
E27	80 CRI		





## 12258 E27-LED-ST64



500 lm

warm  
WHITE

2200 K



L 142, Ø 64



dimmable via  
remote & app



3 x AA  
Battery included



4.9 W



15000 h



220-240V, 50/60Hz



4.9 W ~ 42 W



E27



80 CRI



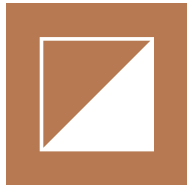

# EGLO ACCESS

EGLO ACCESS  
EGLO ACCESS



**EN EGLO ACCESS**

Light influences our lives and our work. For example, bright neutral white light improves focus, while warm, dimmed light makes us feel comfortable. You can adjust your EGLO Access luminaires to your requirements or mood.

**DE EGLO ACCESS**

Licht beeinflusst unser Leben und unsere Tätigkeiten. Zum Beispiel fördert helles, neutralweißes Licht die Konzentration, wohingegen warmes, gedimmtes Licht uns ein Gefühl von Behaglichkeit gibt. Je nach Anforderung oder Stimmung können Sie Ihre EGLO Access Leuchte individuell einstellen.

**FR EGLO ACCÈS**

La lumière influence nos vies et nos activités. Par exemple, une lumière blanche brillante et neutre favorise la concentration, tandis qu'une lumière chaude et atténuée nous procure une sensation de confort. En fonction de vos besoins ou de votre humeur, vous pouvez régler votre éclairage EGLO Access.





# OVERVIEW

EGLO ACCESS  
EGLO ACCESS  
EGLO ACCESS



ZUBIETA-A  
120-122



FRANIA-A  
123



SARSINA-A  
124



SALOBRENA-A  
126-127



FUEVA-A  
128



This product is available in different colors and shapes. / Dieser Artikel ist in unterschiedlichen Farben und Formen verfügbar. / Cet article est disponible en différentes couleurs et formes.





# LET LIGHT FOLLOW YOUR LIFE

DAS LICHT, DAS SICH IHREM LEBEN ANPASST  
LA LUMIÈRE QUE S'ADAPTE À VOTRE VIE



- › One remote control for different light scenarios
- › 4-predefined settings
- › Tunable white: individually adjustable from warm white to cold white
- › Dimmable with incl. remote control
- › 2 memory functions for individual light

- › Eine Fernbedienung für verschiedene Lichtszenarien
- › 4 vordefinierte Einstellungen
- › Tunable white: individuell einstellbar von Warmweiß bis Kaltweiß
- › Dimmbar mit inkludierter Fernbedienung
- › 2 Speicherfunktionen für individuelles Licht

- › Une seule télécommande pour différents scénarios d'éclairage
- › 4 paramètres prédéfinis à l'emploi
- › Tunable white : réglable individuellement du blanc chaud au blanc froid
- › Graduable avec télécommande incluse
- › 2 fonctions mémoire pour un éclairage individuel

## THE SYSTEM'S ADVANTAGES ARE:

## DIE VORTEILE DES SYSTEMS SIND:

## LES AVANTAGES DU SYSTÈME SONT :



Quick and simple installation

Schnelle und einfache Installation

Installation simple et rapide



One remote control for up to 8 different items and a control distance up to 10 meters.

Eine Fernbedienung für bis zu 8 verschiedene Artikel und steuerbar bis zu 10 Meter

Une seule télécommande pour jusqu'à 8 articles différents et contrôlable jusqu'à 10 mètres



Light colour from 2700K to 6500K

Lichtfarbe von 2700K bis 6500K

Couleur de lumière de 2 700 K à 6 500 K



No internet access necessary

Kein Internetzugang erforderlich

Aucun accès internet nécessaire

# FUNCTIONS

## FUNKTIONEN FONCTIONS

Relax with warm light and leave the hustle and bustle of everyday life behind you. Concentrate on your work or dispel fatigue, with neutral white light the energy level is replenished. EGLO Access offers these possibilities and many more. All functions and highlights at a glance:

- › It works with radio frequency technology and allows 360 degree control
- › Controllable up to a distance of 10 meters
- › Up to 8 different items can be connected
- › Easy handling thanks to 4 ready-made settings and 2 memory functions

NIGHT LIGHT

RELAX MODE

WORK MODE

SWITCH OFF AFTER 30 MINUTES

Mit warmem Licht entspannen und die Hektik des Alltages hinter sich lassen. Konzentriert arbeiten oder die Müdigkeit vertreiben, mit neutralweißem Licht wird das Energielevel wieder aufgefüllt. Diese Möglichkeiten und noch viele mehr bietet Ihnen EGLO Access. Alle Funktionen und Highlights auf einem Blick:

- › Es arbeitet mit Funktechnologie und ermöglicht eine 360-Grad-Steuerung
- › Steuerbar bis zu einer Entfernung von 10 Metern
- › Bis zu 8 verschiedene Artikel können miteinander verbunden werden
- › Einfache Handhabung durch 4 vorgefertigte Einstellungen und 2 Speicherfunktionen

NACHTLICHT

ENTSPANNUNGSMODUS

ARBEITSMODUS

AUSSCHALTEN NACH 30 MINUTEN

Lumière chaude pour se détendre et laisser l'agitation quotidienne derrière soi. Travailler de manière concentrée ou chasser la fatigue, avec une lumière blanche neutre, le niveau d'énergie est rétabli. EGLO Access vous offre ces possibilités et bien d'autres encore. Toutes les fonctions et les points forts en un coup d'œil :

- › Il fonctionne avec la technologie de la fréquence radio et permet un contrôle à 360 degrés
- › Contrôlable jusqu'à une distance de 10 mètres
- › Jusqu'à 8 articles différents peuvent être connectés ensemble
- › Manipulation facile grâce à 4 réglages prêts à l'emploi et 2 fonctions mémoire

VEILLEUSE

MODE DE DÉCOMPRESSION

MODE DE TRAVAIL

EXTINCTION APRÈS 30 MINUTES

## COLOUR TEMPERATURES SCALE / FARBTEMPERATUREN SKALA / ÉCHELLE DES TEMPÉRATURES DE COULEUR





# REMOTE CONTROL

FERNBEDIENUNG  
TÉLÉCOMMANDE

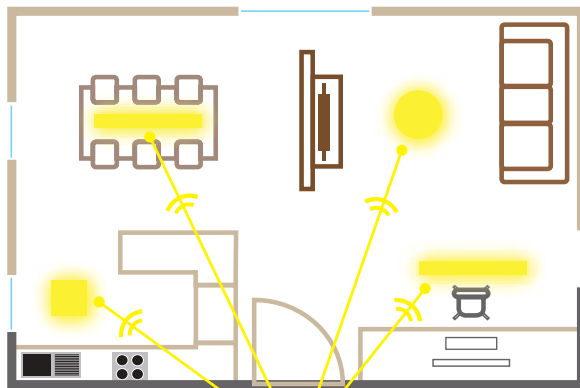
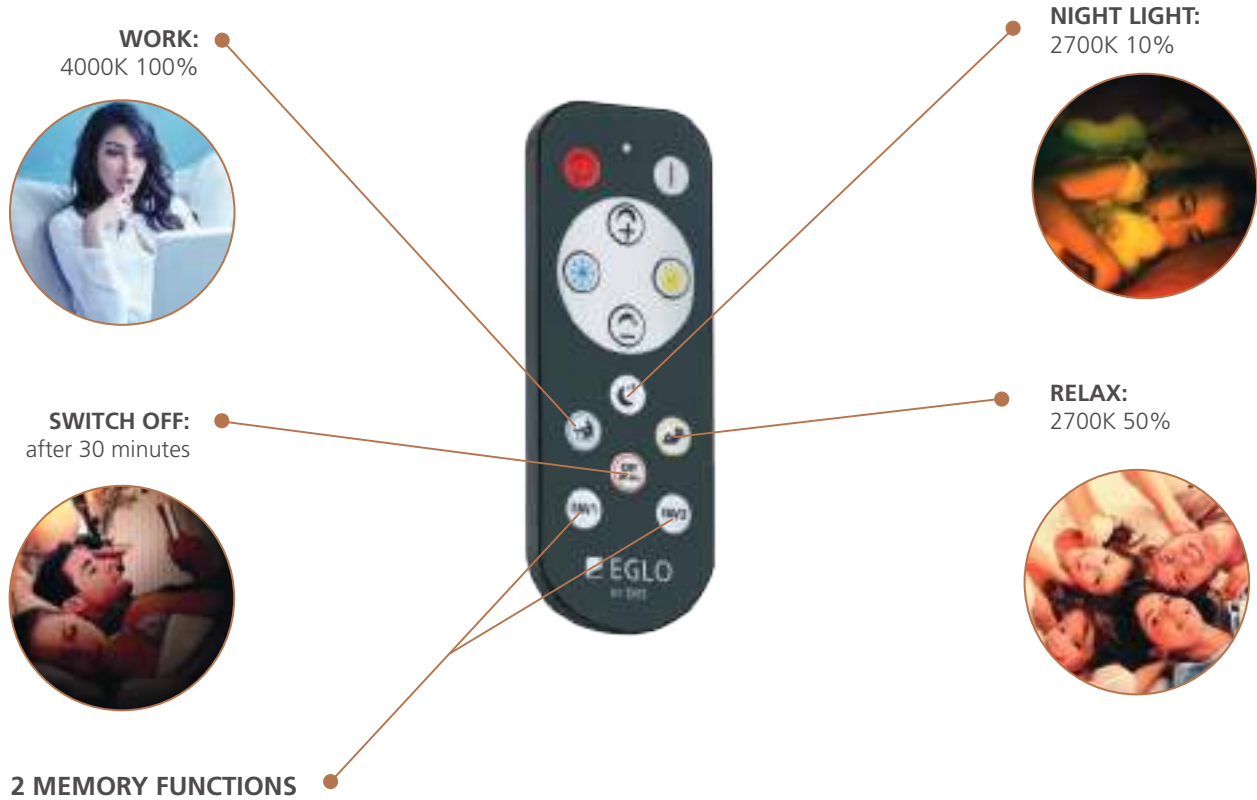

no internet necessary  
kein Internet erforderlich  
nul besoin d'internet



Control up to 8 EGLO Access luminaires  
Bis zu 8 EGLO Access Leuchten steuerbar  
Controlé jusqu'à 8 luminaires EGLO Access



98894

LED



98895

LED



### 98894 ZUBIETA-A

surface-mounted light; steel, black / plastic, white  
Aufbauleuchte; Stahl, schwarz / Kunststoff, weiss  
luminaire en saillie; acier, noir / plastique, blanc

H 40, Ø 300



### 98895 ZUBIETA-A

surface-mounted light; steel, black / plastic, white  
Aufbauleuchte; Stahl, schwarz / Kunststoff, weiss  
luminaire en saillie; acier, noir / plastique, blanc

H 40, Ø 450



### 98896 ZUBIETA-A

surface-mounted light; steel, black / plastic, white  
Aufbauleuchte; Stahl, schwarz / Kunststoff, weiss  
luminaire en saillie; acier, noir / plastique, blanc

H 40, Ø 595



9 002759 988944



9 002759 988951



9 002759 988968





98896

LED

incl./inkl./inclus





98892



98891



98893



### 98891 ZUBIETA-A

surface-mounted light; steel, white / plastic, white  
Aufbauleuchte; Stahl, weiss / Kunststoff, weiss  
luminaire en saillie; acier, blanc / plastique, blanc

H 40, Ø 300



14,6W



1900lm



Remote

### 98892 ZUBIETA-A

surface-mounted light; steel, white / plastic, white  
Aufbauleuchte; Stahl, weiss / Kunststoff, weiss  
luminaire en saillie; acier, blanc / plastique, blanc

H 40, Ø 450



18,8W



2300lm



Remote

### 98893 ZUBIETA-A

surface-mounted light; steel, white / plastic, white  
Aufbauleuchte; Stahl, weiss / Kunststoff, weiss  
luminaire en saillie; acier, blanc / plastique, blanc

H 40, Ø 595



32W



3900lm



Remote



9 002759 988913



9 002759 988920



9 002759 988937





98294



IP44



incl./inkl./inclus



98236



incl./inkl./inclus



98237



incl./inkl./inclus

### 98294 FRANIA-A

wall/ceiling light; steel, white / plastic with crystal effect, white  
Wand- / Deckenleuchte; Stahl, weiss / Kunststoff m.Kristalleffekt, weiss  
Applique/Plafonnier; acier, blanc / plastique avec effet cristal, blanc

H 55, Ø 300



### 98236 FRANIA-A

wall/ceiling light; steel, white / plastic with crystal effect, white  
Wand- / Deckenleuchte; Stahl, weiss / Kunststoff m.Kristalleffekt, weiss  
Applique/Plafonnier; acier, blanc / plastique avec effet cristal, blanc

H 55, Ø 400



### 98237 FRANIA-A

wall/ceiling light; steel, white / plastic with crystal effect, white  
Wand- / Deckenleuchte; Stahl, weiss / Kunststoff m.Kristalleffekt, weiss  
Applique/Plafonnier; acier, blanc / plastique avec effet cristal, blanc

H 75, Ø 570



9 002759 982942



9 002759 982362

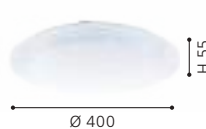

9 002759 982379





98207



98208



### 98207 SARSINA-A

ceiling light; aluminium, white / plastic, white  
Deckenleuchte; Alu, weiss / Kunststoff, weiss  
plafonnier; aluminium, blanc / plastique, blanc

H 50, Ø 300



14W



2000lm



Remote



### 98208 SARSINA-A

ceiling light; aluminium, white / plastic, white  
Deckenleuchte; Alu, weiss / Kunststoff, weiss  
plafonnier; aluminium, blanc / plastique, blanc

H 50, Ø 450



21,5W



2850lm



Remote



### 98209 SARSINA-A

ceiling light; aluminium, white / plastic, white  
Deckenleuchte; Alu, weiss / Kunststoff, weiss  
plafonnier; aluminium, blanc / plastique, blanc

H 50, Ø 600



30W



4000lm



Remote



9 002759 982072

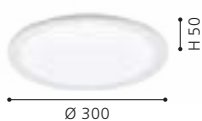

9 002759 982089



9 002759 982096





98209

LED

incl./inkl./inclus





98205

LED



incl./inkl./inclus



98206

LED



incl./inkl./inclus



### 98205 SALOBRENA-A

ceiling light; aluminium, white / plastic, white  
Deckenleuchte; Alu, weiss / Kunststoff, weiss  
plafonnier; aluminium, blanc / plastique, blanc

L 1200, B 300, H 50



31,5W



3900lm



Remote



### 98206 SALOBRENA-A

ceiling light; aluminium, white / plastic, white  
Deckenleuchte; Alu, weiss / Kunststoff, weiss  
plafonnier; aluminium, blanc / plastique, blanc

L 1195, B 100, H 50



30W



3900lm



Remote



### 98297 SALOBRENA-A

ceiling light; aluminium, white / plastic, white  
Deckenleuchte; Alu, weiss / Kunststoff, weiss  
plafonnier; aluminium, blanc / plastique, blanc

L 450, B 450, H 50



20W



2600lm



Remote



9 002759 982058



9 002759 982065

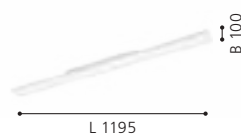

9 002759 982973

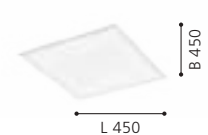





98297



98201



98203



### 98201 SALOBRENA-A

ceiling light; aluminium, white / plastic, white  
Deckenleuchte; Alu, weiss / Kunststoff, weiss  
plafonnier; aluminium, blanc / plastique, blanc

L 300, B 300, H 50



### 98203 SALOBRENA-A

ceiling light; aluminium, white / plastic, white  
Deckenleuchte; Alu, weiss / Kunststoff, weiss  
plafonnier; aluminium, blanc / plastique, blanc

L 600, B 600, H 50



9 002759 982010



9 002759 982034

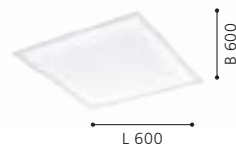



98292



**FUEVA-A**

These luminaires inspire with their extremely flat and elegant design.

Diese Leuchten begeistern durch ihre extrem flache und elegante Bauweise.

Ces lumières enthousiasment par la méthode de construction extrêmement plate et élégante.



98293



**98292 FUEVA-A**

surface-mounted light; aluminium, white / plastic, white  
 Aufbauleuchte; Alu, weiss / Kunststoff, weiss  
 luminaire en saillie; aluminium, blanc / plastique, blanc

H 30, Ø 225



14W



2000lm



Remote



**98293 FUEVA-A**

surface-mounted light; aluminium, white / plastic, white  
 Aufbauleuchte; Alu, weiss / Kunststoff, weiss  
 luminaire en saillie; aluminium, blanc / plastique, blanc

H 30, Ø 300



20W



2650lm



Remote



**98212 FUEVA-A**

recessed light; aluminium, white / plastic, white  
 Einbauleuchte; Alu, weiss / Kunststoff, weiss  
 luminaire encastrable; aluminium, blanc / plastique, blanc

Ø 120, ET 30



5W



700lm



Remote



Ø 108



9 002759 982928



9 002759 982935



9 002759 982126





98212

LED

incl./inkl./inclus





# LIGHTING FAMILIES / FABRIC LUMINAIRES

LEUCHTENFAMILIEN / STOFFLEUCHTEN  
FAMILLES DE LUMINAIRES / LUMINAIRES À TEXTIL

## EN **SIMPLE CLASSINESS**

The textile luminaires with their unusual designs are perfectly trendy and bring cosiness to every home. Selected textiles in natural shades and clear shapes form the basis of a friendly and tasteful living environment in our textile luminaires. Inner coatings in sophisticated gold and classical silver add an air of luxury.

## DE **SCHLICHTE ELEGANZ**

Die Stoffleuchten mit ihrem außergewöhnlichen Design sind voll im Trend und sorgen für Gemütlichkeit in jedem Zuhause. Bei den Stoffleuchten bilden ausgesuchte Stoffe in Naturtönen und klaren Formgebungen die Grundlage für eine freundliche und geschmackvolle Wohnumgebung. Für einen Hauch von Luxus sorgen die Innenbeschichtungen in edlem Gold und klassischem Silber.

## FR **ÉLÉGANCE SIMPLE**

Les luminaires en étoffe avec leur design extraordinaire sont très tendance et assurent un confort dans chaque maison. Chez les luminaires en étoffe, des étoffes sélectionnées dans des tons naturels et des formes claires forment la base d'un cadre de vie convivial et de bon goût. Les revêtements internes en or fin et en argent classique ajoutent une touche de luxe.





# OVERVIEW

LIGHTING FAMILIES / FABRIC LUMINAIRS  
LEUCHTENFAMILIEN / STOFFLEUCHTEN  
FAMILLES DE LUMINAIRES / LUMINAIRES À TEXTIL

 ROMAO 1 136	 ROMAO 136-137	 ROMAO 3 136-137	 PASTERI 138-141,146-161	 PALOMARO 142-143	 PALOMARO 1 143	 PASTORE 144	 PASTORE 1 144
 PASTORE 2 145	 VISERBELLA 162-164	 ESTEPERRA 166-169	 VARILLAS 171	 MARASALES 172-174	 ZARAGOZA 176-177	 BUCAMARANGA 178	 MASERLO 180-181,184-193
 MASERLO 2 180, 186, 189, 192	 MASERLO 1 182-183	 CONCESSA 1 194-195	 ALBARIZA 196	 FENIGLIA 198-199	 ALMEIDA 2 200-201	 NASTASIA 202	 AGLIENTINA 203
 ALMEIDA 1 204	 ALMEIDA 205	 MARONDA 205					



This product is available in different colors and shapes. / Dieser Artikel ist in unterschiedlichen Farben und Formen verfügbar. /  
Cet article est disponible en différentes couleurs et formes.



Lighting Families / Wood luminaires starts on page 206.  
Leuchtenfamilien / Holzleuchten starten auf Seite 206.  
Familles d'éclairage / Luminaires à bois commence à la page 206.



Lighting Families / Essential luminaires starts on page 228.  
Leuchtenfamilien / Standardleuchten starten auf Seite 228.  
Familles d'éclairage / Luminaires standard commence à la page 228.



Lighting Families / Glass chandeliers starts on page 336.  
Leuchtenfamilien / Glasluster starten auf Seite 336.  
Familles d'éclairage / lustres en verre commence à la page 336.



# FABRIC MATERIALS

STOFF MATERIALIEN  
MATÉRIAUX EN TISSU

## SHADES / SCHIRME / OMBRES

### GLOSSY / GLÄNZEND / GLOSSY



fabric, glossy black  
Textil, samtglänzend schwarz  
tissu, velours noir brillant



fabric, glossy taupe  
Textil, samtglänzend taupe  
tissu, velours taupe brillant



fabric, glossy cappucino  
Textil, samtglänzend cappucino  
tissu, velours cappucino brillant



fabric, glossy grey  
Textil, samtglänzend grau  
tissu, velours gris brillant



fabric, glossy white  
Textil, samtglänzend weiß  
tissu, velours blanc brillant



fabric, glossy gold  
Textil, samtglänzend gold  
tissu, velours or brillant

### MAT / MATT / MAT



fabric, mat black  
Textil, matt schwarz  
tissu, tapis noir



fabric, mat taupe  
Textil, matt taupe  
tissu, tapis taupe



fabric, mat anthracite-brown  
Textil, matt anthrazit-braun  
tissu, tapis anthracite-marron

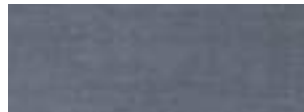

fabric, mat grey  
Textil, matt grau  
tissu, tapis gris



fabric, mat white  
Textil, matt weiß  
tissu, tapis blanc



fabric, mat white & gold  
Textil, matt weiß & gold  
tissu, tapis blanc & or

### LINEN / LEINEN / LIN



linen, grey  
Leinen, grau  
lin, gris



linen, brown  
Leinen, braun  
lin, marron

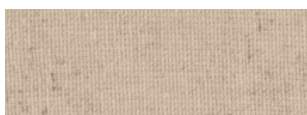

linen, natural  
Leinen, natur  
lin, nature



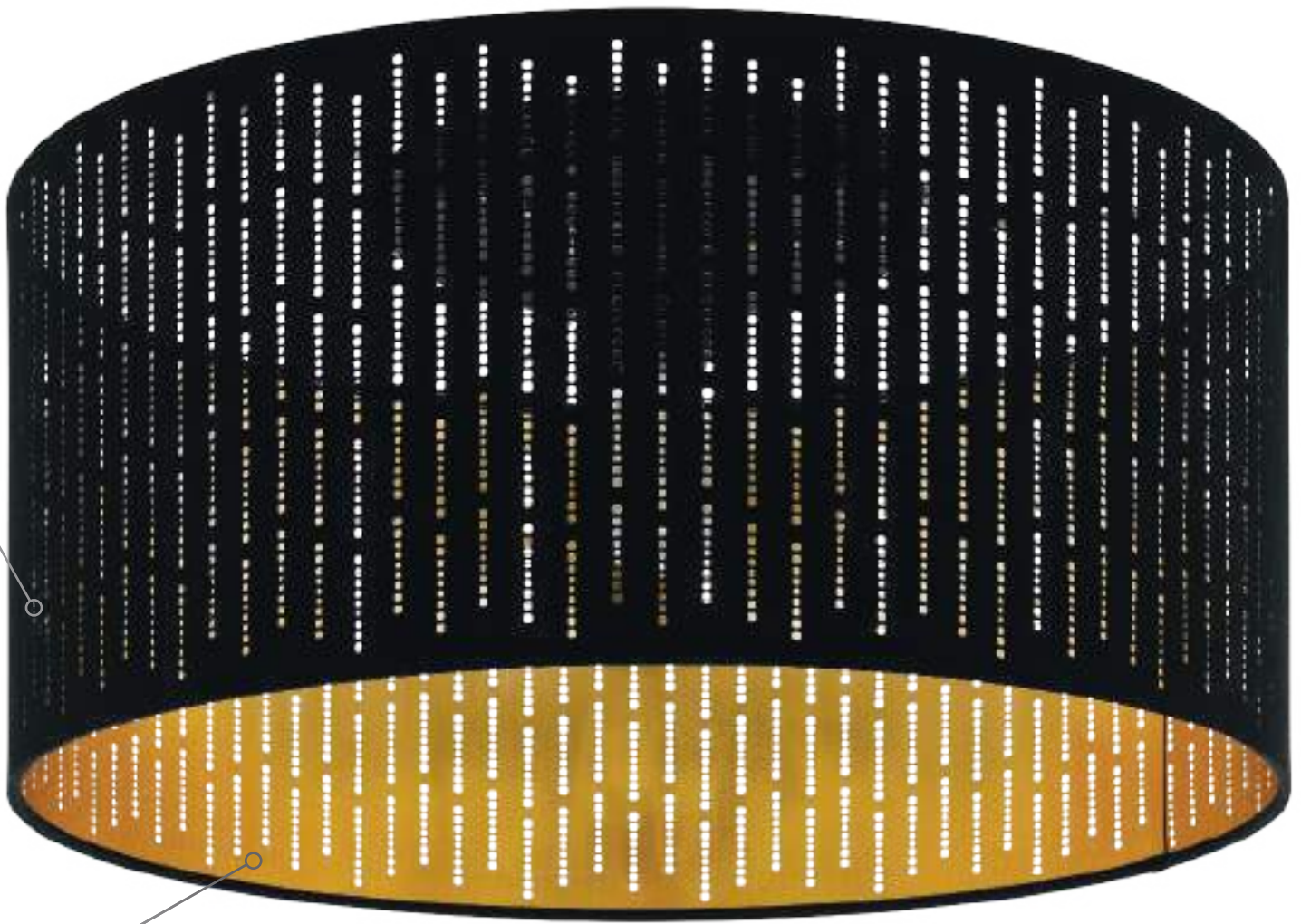

## COATING / BESCHICHTUNG / REVÊTEMENT



coating, silver  
Beschichtung, silber  
revêtement, argent

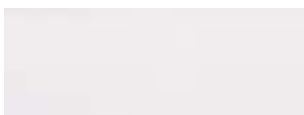

coating, white  
Beschichtung, weiß  
revêtement, blanc



coating, black  
Beschichtung, schwarz  
revêtement, noir



coating, gold  
Beschichtung, gold  
revêtement, or



coating, copper  
Beschichtung, kupfer  
revêtement, cuivre



coating, brass  
Beschichtung, messing  
revêtement, laiton



coating, brass & white  
Beschichtung, messing & weiß  
revêtement, laiton & blanc



97777

LED

incl./inkl./inclus



97778

LED

incl./inkl./inclus



97779

LED

incl./inkl./inclus



### 97777 ROMAO 1

ceiling light; steel, white / fabric, plastic, white  
Deckenleuchte; Stahl, weiss / Textil, Kunststoff, weiss  
plafonnier; acier, blanc / tissu, plastique, blanc

H 120, Ø 570

LED

36W

tunable  
WHITE

4300lm



Remote

### 97779 ROMAO

ceiling light; steel, white / fabric linen, plastic, grey, white  
Deckenleuchte; Stahl, weiss / Textil Leinen, Kunststoff, grau,  
weiss  
plafonnier; acier, blanc / tissu de lin, plastique, gris, blanc

H 120, Ø 570

LED

36W

tunable  
WHITE

4300lm



Remote

### 97778 ROMAO 3

ceiling light; steel, white / fabric, plastic, taupe, white  
Deckenleuchte; Stahl, weiss / Textil, Kunststoff, taupe, weiss  
plafonnier; acier, blanc / tissu, plastique, taupe, blanc

H 120, Ø 570

LED

36W

tunable  
WHITE

4300lm



Remote



9 002759 977771



9 002759 977795



9 002759 977788





97783



97784



<b>TUNABLE WHITE</b> 3000 - 5000K	<b>DIMMABLE</b> 10 - 100%	<b>TIMER FUNCTION</b> off after 30sec.	<b>NIGHT LIGHT FUNCTION</b>	<u>97777</u>	<u>97783</u>
				<u>97778</u>	<u>97784</u>
				<u>97779</u>	

see page / siehe Seite / voir la page 478

### 97784 ROMAO

ceiling light; steel, white / fabric linen, plastic, grey, white  
Deckenleuchte; Stahl, weiss / Textil Leinen, Kunststoff, grau, weiss  
plafonnier; acier, blanc / tissu de lin, plastique, gris, blanc

H 120, Ø 760



### 97783 ROMAO 3

ceiling light; steel, white / fabric, plastic, taupe, white  
Deckenleuchte; Stahl, weiss / Textil, Kunststoff, taupe, weiss  
plafonnier; acier, blanc / tissu, plastique, taupe, blanc

H 120, Ø 760



9 002759 977849



9 002759 977832

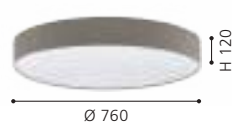



### 97611 PASTERI

ceiling light; steel, white / fabric, white  
Deckenleuchte; Stahl, weiss / Textil, weiss  
plafonnier; acier, blanc / tissu, blanc

H 150, Ø 570



### 97615 PASTERI

ceiling light; steel, white / fabric, white  
Deckenleuchte; Stahl, weiss / Textil, weiss  
plafonnier; acier, blanc / tissu, blanc

H 150, Ø 760



### 97619 PASTERI

ceiling light; steel, white / fabric, white  
Deckenleuchte; Stahl, weiss / Textil, weiss  
plafonnier; acier, blanc / tissu, blanc

H 170, Ø 980





97613



97617



### 97613 PASTERI

ceiling light; steel, white / fabric, linen, grey, white  
Deckenleuchte; Stahl, weiss / Textil, Leinen, grau, weiss  
plafonnier; acier, blanc / tissu, lin, gris, blanc

H 150, Ø 570



9 002759 976132



### 97617 PASTERI

ceiling light; steel, white / fabric, linen, grey, white  
Deckenleuchte; Stahl, weiss / Textil, Leinen, grau, weiss  
plafonnier; acier, blanc / tissu, lin, gris, blanc

H 150, Ø 760



9 002759 976170





### 97614 PASTERI

ceiling light; steel, white / fabric, linen, brown, white  
Deckenleuchte; Stahl, weiss / Textil, Leinen, braun, weiss  
plafonnier; acier, blanc / tissu, lin, marron, blanc

H 150, Ø 570



### 97618 PASTERI

ceiling light; steel, white / fabric, linen, brown, white  
Deckenleuchte; Stahl, weiss / Textil, Leinen, braun, weiss  
plafonnier; acier, blanc / tissu, lin, marron, blanc

H 150, Ø 760





### 97612 PASTERI

ceiling light; steel, white / fabric, taupe, white  
Deckenleuchte; Stahl, weiss / Textil, taupe, weiss  
plafonnier; acier, blanc / tissu, taupe, blanc

H 150, Ø 570



### 97616 PASTERI

ceiling light; steel, white / fabric, taupe, white  
Deckenleuchte; Stahl, weiss / Textil, taupe, weiss  
plafonnier; acier, blanc / tissu, taupe, blanc

H 150, Ø 760



### 97621 PASTERI

ceiling light; steel, white / fabric, taupe, white  
Deckenleuchte; Stahl, weiss / Textil, taupe, weiss  
plafonnier; acier, blanc / tissu, taupe, blanc

H 170, Ø 980





93397

LED

### 93397 PALOMARO

ceiling light; plastic, white / fabric, anthracite  
Deckenleuchte; Kunststoff, weiss / Textil, anthrazit  
plafonnier; plastique, blanc / tissu, anthracite

H 110, Ø 500

LED

warm  
WHITE



4x 5,4W 2200lm



9 002759 933975







96538

LED



96539

LED



93952

LED

### 96538 PALOMARO 1

ceiling light; plastic, white / fabric, anthracite  
Deckenleuchte; Kunststoff, weiss / Textil, anthrazit  
plafonnier; plastique, blanc / tissu, anthracite

H 100, Ø 405

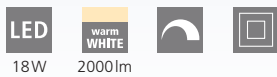

18W 2000lm

### 96539 PALOMARO 1

ceiling light; plastic, white / fabric, taupe  
Deckenleuchte; Kunststoff, weiss / Textil, taupe  
plafonnier; plastique, blanc / tissu, taupe

H 100, Ø 405



18W 2000lm

### 93952 PALOMARO

ceiling light; plastic, white / fabric, taupe  
Deckenleuchte; Kunststoff, weiss / Textil, taupe  
plafonnier; plastique, blanc / tissu, taupe

H 110, Ø 500



4x 5,4W 2200lm



9 002759 965389

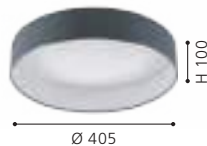

9 002759 965396



9 002759 939526





**97479**



**97838**



**98409**

### 97479 PASTORE

ceiling light; steel, white / fabric, anthracite-brown, white, grey  
Deckenleuchte; Stahl, weiss / Textil, anthrazit-braun, weiss, grau  
plafonnier; acier, blanc / tissu, marron anthracite, blanc, gri

L 610, B 495, H 255



E27



3x 60W

### 97838 PASTORE

ceiling light; steel, white / fabric, brown, grey, white, black  
Deckenleuchte; Stahl, weiss / Textil, braun, grau, weiss, schwarz  
plafonnier; acier, blanc / tissu, marron, gris, blanc, noir

H 285, Ø 990



E27



6x 40W

### 98409 PASTORE 1

ceiling light; steel, white / fabric, taupe  
Deckenleuchte; Stahl, weiss / Textil, taupe  
plafonnier; acier, blanc / tissu, taupe

H 250, Ø 990



E27



6x 40W



9 002759 974794



L 610



9 002759 978389



Ø 990



9 002759 984090



Ø 990



99508



99509



PASTORE | PASTORE 1  
PASTORE 2

### 99508 PASTORE 2

ceiling light; steel, white / fabric, black, white  
Deckenleuchte; Stahl, weiss / Textil, schwarz, weiss  
plafonnier; acier, blanc / tissu, noir, blanc

L 610, B 495, H 255



E27



3x 60W



9 002759 995089



L 610

### 99509 PASTORE 2

ceiling light; steel, white / fabric, black, white  
Deckenleuchte; Stahl, weiss / Textil, schwarz, weiss  
plafonnier; acier, blanc / tissu, noir, blanc

H 285, Ø 990



E27



6x 40W



9 002759 995096



Ø 990

DESIGN  
HIGHLIGHT  
DETAIL



**31581**



**31572**

### 31581 PASTERI

pendant light; steel, satin nickel / fabric, taupe  
Hängeleuchte; Stahl, nickel-matt / Textil, taupe  
luminaire en suspension; acier, nickel mat / tissu, taupe

L 750, B 220, H 1100



E27 2x 60W

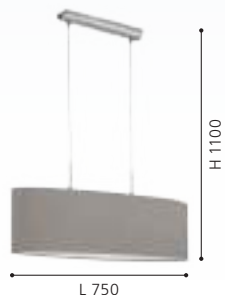

### 31572 PASTERI

pendant light; steel, satin nickel / fabric, taupe  
Hängeleuchte; Stahl, nickel-matt / Textil, taupe  
luminaire en suspension; acier, nickel mat / tissu, taupe

H 1100, Ø 380



E27 1x 60W



### 31589 PASTERI

ceiling light; plastic, steel, white / fabric, taupe  
Deckenleuchte; Kunststoff, Stahl, weiss / Textil, taupe  
plafonnier; plastique, acier, blanc / tissu, taupe

H 90, Ø 320



LED warm WHITE 3x 3,6W 1110lm





31589

LED

### 31576 PASTERI

pendant light; steel, satin nickel / fabric, taupe  
Hängeleuchte; Stahl, nickel-matt / Textil, taupe  
luminaire en suspension; acier, nickel mat / tissu, taupe

H 1100, Ø 530



E27



1x 60W



9 002759 315764



31576



94919



### 94919 PASTERI

ceiling light; steel, satin nickel / fabric, glass, taupe  
Deckenleuchte; Stahl, nickel-matt / Textil, Glas, taupe  
plafonnier; acier, nickel mat / tissu, verre, taupe

H 195, Ø 475



### 94925 PASTERI

wall light; steel, satin nickel / fabric, taupe  
Wandleuchte; Stahl, nickel-matt / Textil, taupe  
Applique; acier, nickel mat / tissu, taupe

L 145, H 305, A 195

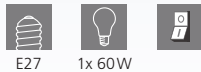

### 96478 PASTERI

wall light; steel, satin nickel / fabric, taupe  
Wandleuchte; Stahl, nickel-matt / Textil, taupe  
Applique; acier, nickel mat / tissu, taupe

L 150, H 380, A 195

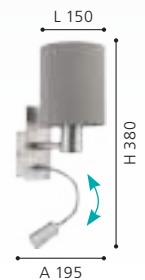



**31595**



**95167**

### 31595 PASTERI

table light; steel, satin nickel / fabric, taupe  
Tischleuchte; Stahl, nickel-matt / Textil, taupe  
luminaire de table; acier, nickel mat / tissu, taupe

H 400, Ø 180, Base: Ø 150

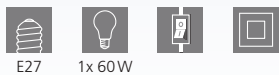

E27 1x 60W



9 002759 315955

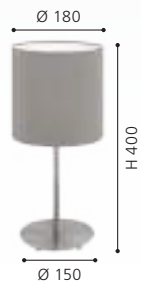

### 95167 PASTERI

floor light; steel, satin nickel / fabric, taupe  
Stehleuchte; Stahl, nickel-matt / Textil, taupe  
lampadaire; acier, nickel mat / tissu, taupe

H 1575, Ø 280, Base: Ø 230



E27 1x 60W



9 002759 951672





31592

LED



31582

### 31592 PASTERI

ceiling light; plastic, steel, white / fabric, grey  
 Deckenleuchte; Kunststoff, Stahl, weiss / Textil, grau  
 plafonnier; plastique, acier, blanc / tissu, gris

H 90, Ø 320



3x 3,6W 1110lm



9 002759 315924



### 31582 PASTERI

pendant light; steel, satin nickel / fabric, grey  
 Hängeleuchte; Stahl, nickel-matt / Textil, grau  
 luminaire en suspension; acier, nickel mat / tissu, gris

L 750, B 220, H 1100



E27 2x 60W



9 002759 315825







94921



31573



31577

### 94921 PASTERI

ceiling light; steel, satin nickel / fabric, glass, grey  
Deckenleuchte; Stahl, nickel-matt / Textil, Glas, grau  
plafonnier; acier, nickel mat / tissu, verre, gris

H 195, Ø 475



9 002759 949211



### 31577 PASTERI

pendant light; steel, satin nickel / fabric, grey  
Hängeleuchte; Stahl, nickel-matt / Textil, grau  
luminaire en suspension; acier, nickel mat / tissu, gris

H 1100, Ø 530



9 002759 315771



### 31573 PASTERI

pendant light; steel, satin nickel / fabric, grey  
Hängeleuchte; Stahl, nickel-matt / Textil, grau  
luminaire en suspension; acier, nickel mat / tissu, gris

H 1100, Ø 380



9 002759 315733





**94926**



**96479**

LED

**94926 PASTERI**

wall light; steel, satin nickel / fabric, grey  
 Wandleuchte; Stahl, nickel-matt / Textil, grau  
 Applique; acier, nickel mat / tissu, gris

L 145, H 305, A 195

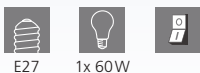

E27 1x 60W



9 002759 949266



**96479 PASTERI**

wall light; steel, satin nickel / fabric, grey  
 Wandleuchte; Stahl, nickel-matt / Textil, grau  
 Applique; acier, nickel mat / tissu, gris

L 150, H 380, A 195



E27 1x 40W 1x 3,8W 320lm



9 002759 964795

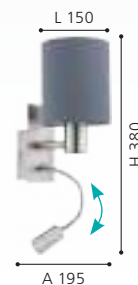



**95119**



**95119**

These luminaires can be switched on and off by touching the specially designed "Touch Me" part of the fixture.

Diese Leuchten können ein- und ausgeschaltet werden, indem man sie an den dafür vorgesehenen „Touch Me“ Bereichen berührt.

Ces luminaires peuvent être éteints et allumés simplement en touchant la partie spécialement conçue pour «Touch Me» du luminaire.



**31596**



**95166**

### 95119 PASTERI

table light; steel, satin nickel / fabric, grey  
Tischleuchte; Stahl, nickel-matt / Textil, grau  
luminaire de table; acier, nickel mat / tissu, gris

H 255, Ø 120



E27 1x 40W



9 002759 951191



Ø 120

### 31596 PASTERI

table light; steel, satin nickel / fabric, grey  
Tischleuchte; Stahl, nickel-matt / Textil, grau  
luminaire de table; acier, nickel mat / tissu, gris

H 400, Ø 180, Base: Ø 150



E27 1x 60W



9 002759 315962



Ø 150

### 95166 PASTERI

floor light; steel, satin nickel / fabric, grey  
Stehleuchte; Stahl, nickel-matt / Textil, grau  
lampadaire; acier, nickel mat / tissu, gris

H 1575, Ø 280, Base: Ø 230



E27 1x 60W



9 002759 951665



Ø 230



31574





31578



96481

The main and reading lights can be switched on separately.

Das Haupt- und das Leselicht können getrennt voneinander geschaltet werden.

Les luminaires principales et de lecture peuvent être allumées séparément.

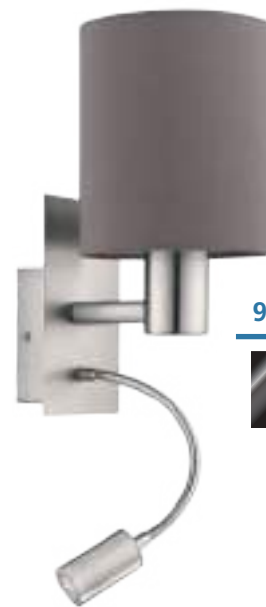

96481

LED

### 31574 PASTERI

pendant light; steel, satin nickel / fabric, anthracite-brown  
Hängeleuchte; Stahl, nickel-matt / Textil, anthrazit-braun  
luminaire en suspension; acier, nickel mat / tissu, marron anthracite

H 1100, Ø 380



### 31578 PASTERI

pendant light; steel, satin nickel / fabric, anthracite-brown  
Hängeleuchte; Stahl, nickel-matt / Textil, anthrazit-braun  
luminaire en suspension; acier, nickel mat / tissu, marron anthracite

H 1100, Ø 530



### 96481 PASTERI

wall light; steel, satin nickel / fabric, anthracite-brown  
Wandleuchte; Stahl, nickel-matt / Textil, anthrazit-braun  
Applique; acier, nickel mat / tissu, marron anthracite

L 150, H 380, A 195

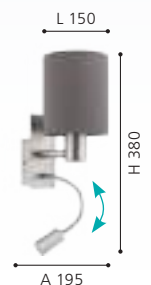



**31571**

### 31571 PASTERI

pendant light; steel, satin nickel / fabric, white  
Hängeleuchte; Stahl, nickel-matt / Textil, weiss  
luminaire en suspension; acier, nickel mat / tissu, blanc

H 1100, Ø 380



E27



1x 60W



9 002759 315719

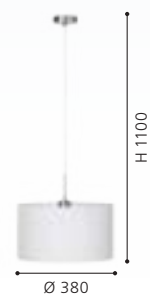



### 31575 PASTERI

pendant light; steel, satin nickel / fabric, white  
 Hängeleuchte; Stahl, nickel-matt / Textil, weiss  
 luminaire en suspension; acier, nickel mat / tissu, blanc

H 1100, Ø 530

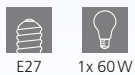

### 94918 PASTERI

ceiling light; steel, satin nickel / fabric, glass, white  
 Deckenleuchte; Stahl, nickel-matt / Textil, Glas, weiss  
 plafonnier; acier, nickel mat / tissu, verre, blanc

H 195, Ø 475



### 31588 PASTERI

ceiling light; plastic, steel, white / fabric, white  
 Deckenleuchte; Kunststoff, Stahl, weiss / Textil, weiss  
 plafonnier; plastique, acier, blanc / tissu, blanc

H 90, Ø 320

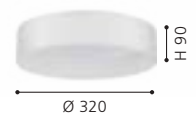



94924



95118



96477

LED

95118

These luminaires can be switched on and off by touching the specially designed "Touch Me" part of the fixture.

Diese Leuchten können ein- und ausgeschaltet werden, indem man sie an den dafür vorgesehenen „Touch Me“ Bereichen berührt.

Ces luminaires peuvent être éteints et allumés simplement en touchant la partie spécialement conçue pour «Touch Me» du luminaire.



### 96477 PASTERI

wall light; steel, satin nickel / fabric, white  
Wandleuchte; Stahl, nickel-matt / Textil, weiss  
Applique; acier, nickel mat / tissu, blanc

L 150, H 380, A 195

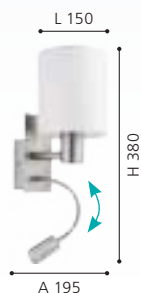

### 94924 PASTERI

wall light; steel, satin nickel / fabric, white  
Wandleuchte; Stahl, nickel-matt / Textil, weiss  
Applique; acier, nickel mat / tissu, blanc

L 145, H 305, A 195

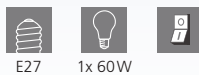

### 95118 PASTERI

table light; steel, satin nickel / fabric, white  
Tischleuchte; Stahl, nickel-matt / Textil, weiss  
luminaire de table; acier, nickel mat / tissu, blanc

H 255, Ø 120

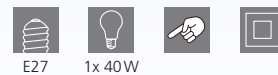





**31594**



**95164**

**31594 PASTERI**

table light; steel, satin nickel / fabric, white  
Tischleuchte; Stahl, nickel-matt / Textil, weiss  
luminaire de table; acier, nickel mat / tissu, blanc

H 400, Ø 180, Base: Ø 150

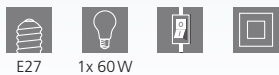

E27 1x 60W



9 002759 315948



**95164 PASTERI**

floor light; steel, satin nickel / fabric, white  
Stehleuchte; Stahl, nickel-matt / Textil, weiss  
lampadaire; acier, nickel mat / tissu, blanc

H 1575, Ø 280, Base: Ø 230



E27 1x 60W



9 002759 951641





DESIGN  
HIGHLIGHT  
DETAIL



### 95045 PASTERI

pendant light; steel, satin nickel / fabric, white, copper  
Hängeleuchte; Stahl, nickel-matt / Textil, weiss, kupfer  
luminaire en suspension; acier, nickel mat / tissu, blanc, cuivre

H 1100, Ø 530



### 96484 PASTERI

wall light; steel, satin nickel / fabric, white, copper  
Wandleuchte; Stahl, nickel-matt / Textil, weiss, kupfer  
Applique; acier, nickel mat / tissu, blanc, cuivre

L 150, H 380, A 195





900701

LED



96483

LED

### 900701 PASTERI

wall light; steel, black / fabric, anthracite-brown  
Wandleuchte; Stahl, schwarz / Textil, anthrazit-braun  
Applique; acier, noir / tissu, marron anthracite

L 150, H 380, A 195



E27 1x 40W 1x 3,8W 320lm



9 008606 251728

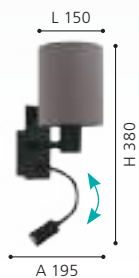

### 96483 PASTERI

wall light; steel, satin nickel / fabric, black, copper  
Wandleuchte; Stahl, nickel-matt / Textil, schwarz, kupfer  
Applique; acier, nickel mat / tissu, noir, cuivre

L 150, H 380, A 195



E27 1x 40W 1x 3,8W 320lm



9 002759 964832

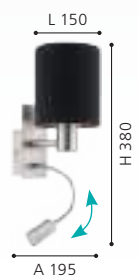

### 96483, 96484, 900701

The main and reading lights can be switched on separately.

Das Haupt- und das Leselicht können getrennt voneinander geschaltet werden.

Les luminaires principales et de lecture peuvent être allumées séparément.



**97643**



**97644**

**97643 VISERBELLA**

pendant light; steel, champagne / fabric, gold  
 Hängeleuchte; Stahl, champagner / Textil, gold  
 luminaire en suspension; acier, champagne / tissu, doré

H 1100, Ø 380

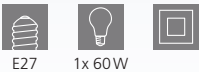

9 002759 976439



**97644 VISERBELLA**

pendant light; steel, champagne / fabric, gold  
 Hängeleuchte; Stahl, champagner / Textil, gold  
 luminaire en suspension; acier, champagne / tissu, doré

H 1100, Ø 530



9 002759 976446



**97641 VISERBELLA**

ceiling light; steel, champagne / fabric, gold  
 Deckenleuchte; Stahl, champagner / Textil, gold  
 plafonnier; acier, champagne / tissu, doré

H 110, Ø 380



9 002759 976415





97641



97642



97641 | 97642



### 97642 VISERBELLA

ceiling light; steel, champagne / fabric, gold  
Deckenleuchte; Stahl, champagner / Textil, gold  
plafonnier; acier, champagne / tissu, doré

H 195, Ø 470



9 002759 976422





DESIGN  
HIGHLIGHT  
DETAIL



97645



97647

### 97645 VISERBELLA

wall light; steel, champagne / fabric, gold  
Wandleuchte; Stahl, champagner / Textil, gold  
Applique; acier, champagne / tissu, doré

L 145, H 305, A 195

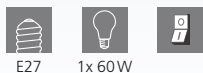

E27 1x 60W



9 002759 976453



### 97647 VISERBELLA

floor light; steel, champagne / fabric, gold  
Stehleuchte; Stahl, champagner / Textil, gold  
lampadaire; acier, champagne / tissu, doré

H 1585, Ø 280, Base: Ø 230



E27 1x 60W



9 002759 976477

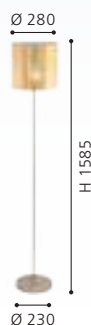

### 97646 VISERBELLA

table light; steel, champagne / fabric, gold  
Tischleuchte; Stahl, champagner / Textil, gold  
luminaire de table; acier, champagne / tissu, doré

H 400, Ø 180, Base: Ø 150



E27 1x 60W



9 002759 976460





97646



DESIGN  
HIGHLIGHT  
DETAIL



99272

99273

### 99273 ESTEPERRA

pendant light; steel, black / fabric, black, gold  
Hängeleuchte; Stahl, schwarz / Textil, schwarz, gold  
luminaire en suspension; acier, noir / tissu, noir, or

H 1100, Ø 380



### 99272 ESTEPERRA

ceiling light; steel, black / fabric, black, gold  
Deckenleuchte; Stahl, schwarz / Textil, schwarz, gold  
plafonnier; acier, noir / tissu, noir, or

H 240, Ø 475

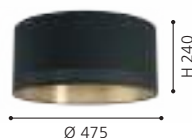

### 99274 ESTEPERRA

pendant light; steel, black / fabric, black, gold  
Hängeleuchte; Stahl, schwarz / Textil, schwarz, gold  
luminaire en suspension; acier, noir / tissu, noir, or

H 1100, Ø 530







99274



99279

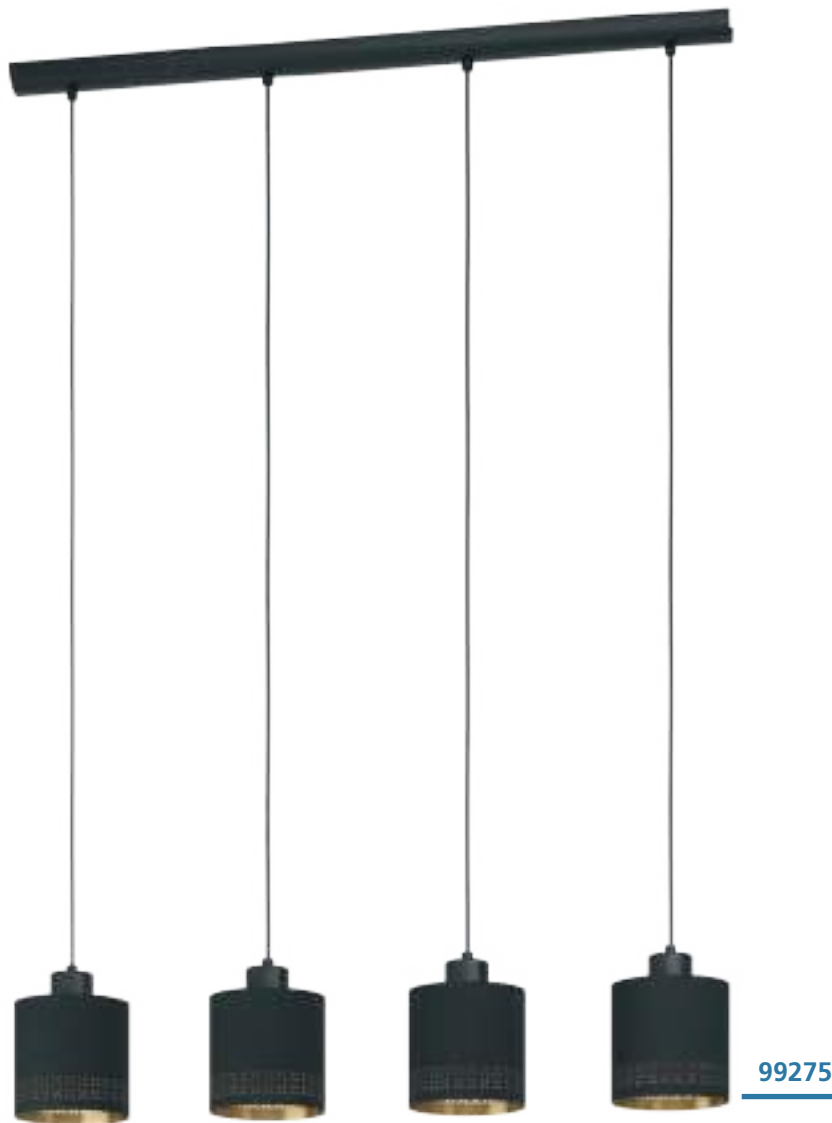

DESIGN  
HIGHLIGHT  
DETAIL



### 99279 ESTEPERRA

floor light; steel, black / fabric, black, gold  
Stehleuchte; Stahl, schwarz / Textil, schwarz, gold  
lampadaire; acier, noir / tissu, noir, or

H 1405, Ø 380, Base: Ø 645



E27 1x 40W



9 002759 992798

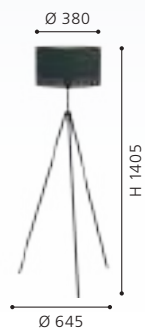

### 99275 ESTEPERRA

pendant light; steel, black / fabric, black, gold  
Hängeleuchte; Stahl, schwarz / Textil, schwarz, gold  
luminaire en suspension; acier, noir / tissu, noir, or

L 940, B 160, H 1100



E27 4x 28W



9 002759 992750

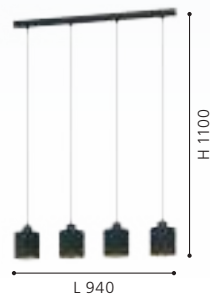



98313



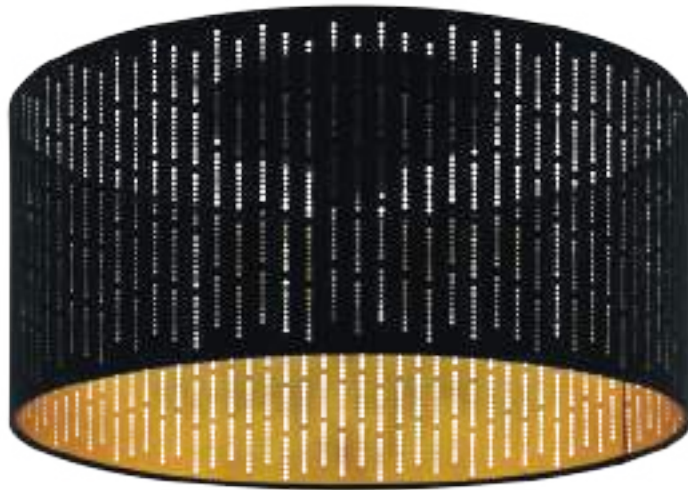

98311



98314



### 98313 VARILLAS

pendant light; steel, black / fabric with cut-outs, black, gold  
 Hängeleuchte; Stahl, schwarz / Textil mit Ausstanzungen, schwarz, gold  
 luminaire en suspension; acier, noir / tissu avec découpes, noir, or

H 1100, Ø 530



### 98311 VARILLAS

ceiling light; steel, black / fabric with cut-outs, black, gold  
 Deckenleuchte; Stahl, schwarz / Textil mit Ausstanzungen, schwarz, gold  
 plafonnier; acier, noir / tissu avec découpes, noir, or

H 240, Ø 475

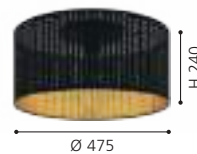

### 98314 VARILLAS

table light; steel, black / fabric with cut-outs, black, gold  
 Tischleuchte; Stahl, schwarz / Textil mit Ausstanzungen, schwarz, gold  
 luminaire de table; acier, noir / tissu avec découpes, noir, or

H 255, Ø 120

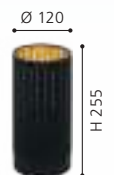
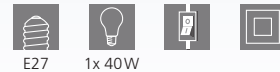

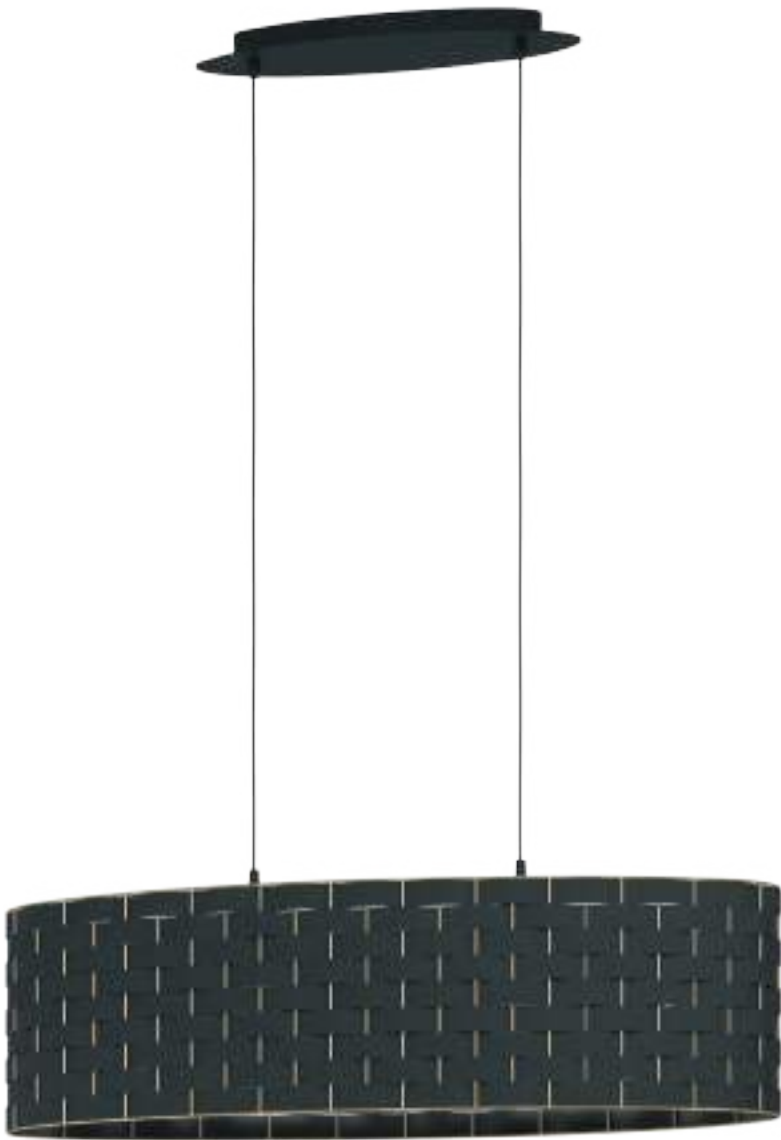

99613

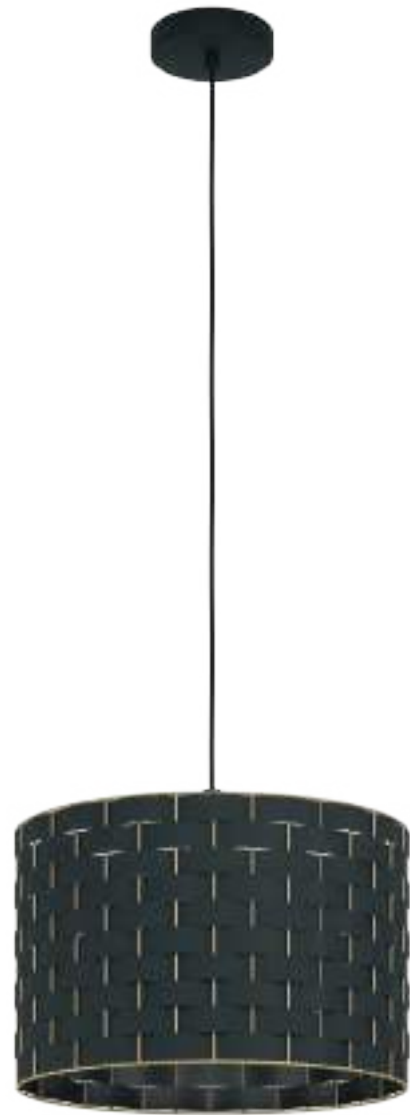

99524

### 99613 MARASALES

pendant light; steel, black / fabric, black, brass  
 Hängeleuchte; Stahl, schwarz / Textil, schwarz, messing  
 luminaire en suspension; acier, noir / tissu, noir, laiton

L 780, B 220, H 1100



9 002759 996130

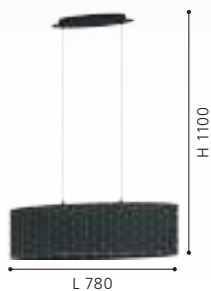

### 99524 MARASALES

pendant light; steel, black / fabric, black, brass  
 Hängeleuchte; Stahl, schwarz / Textil, schwarz, messing  
 luminaire en suspension; acier, noir / tissu, noir, laiton

H 1100, Ø 380



9 002759 995249



### 99525 MARASALES

pendant light; steel, black / fabric, black, brass  
 Hängeleuchte; Stahl, schwarz / Textil, schwarz, messing  
 luminaire en suspension; acier, noir / tissu, noir, laiton

H 1100, Ø 550

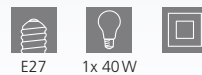

9 002759 995256





99525





99523



99526

### 99523 MARASALES

ceiling light; steel, black / fabric, black, brass  
Deckenleuchte; Stahl, schwarz / Textil, schwarz, messing  
plafonnier; acier, noir / tissu, noir, laiton

H 250, Ø 480

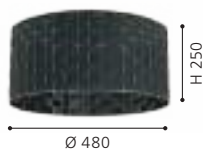

### 99526 MARASALES

table light; steel, black / fabric, black, brass  
Tischleuchte; Stahl, schwarz / Textil, schwarz, messing  
luminaire de table; acier, noir / tissu, noir, laiton

H 570, Ø 280



### 99527 MARASALES

floor light; steel, black / fabric, black, brass  
Stehleuchte; Stahl, schwarz / Textil, schwarz, messing  
lampadaire; acier, noir / tissu, noir, laiton

H 1490, Ø 450, Base: Ø 745

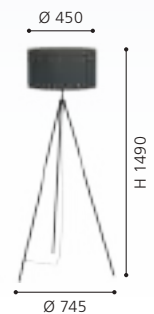





99527



**900145**



**900144**



**900146**

### 900145 ZARAGOZA

pendant light; steel, black / fabric with decoration, black, gold  
 Hängeleuchte; Stahl, schwarz / Textil mit Dekor, schwarz, gold  
 luminaire en suspension; acier, noir / tissu avec décor, noir, or

H 1100, Ø 380



### 900144 ZARAGOZA

ceiling light; steel, black / fabric with decoration, black, gold  
 Deckenleuchte; Stahl, schwarz / Textil mit Dekor, schwarz, gold  
 plafonnier; acier, noir / tissu avec décor, noir, or

H 240, Ø 475



### 900146 ZARAGOZA

pendant light; steel, black / fabric with decoration, black, gold  
 Hängeleuchte; Stahl, schwarz / Textil mit Dekor, schwarz, gold  
 luminaire en suspension; acier, noir / tissu avec décor, noir, or

H 1100, Ø 530

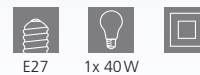



**900147**

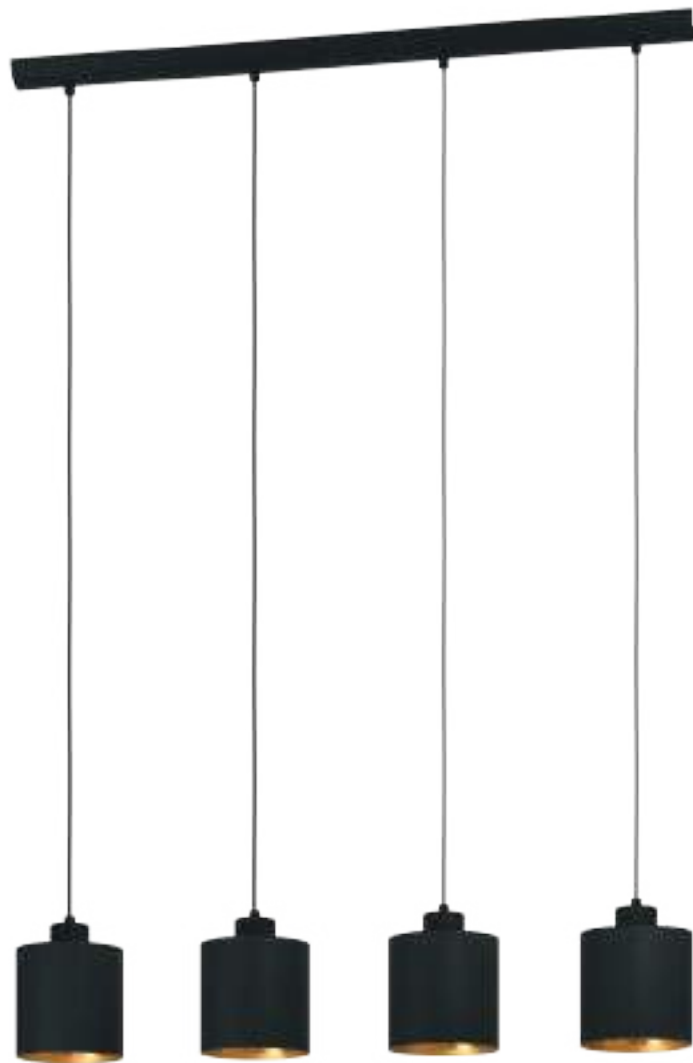

**900148**

**900147 ZARAGOZA**

pendant light; steel, black / fabric with decoration, black, gold  
 Hängeleuchte; Stahl, schwarz / Textil mit Dekor, schwarz, gold  
 luminaire en suspension; acier, noir / tissu avec décor, noir, or

L 780, B 220, H 1100

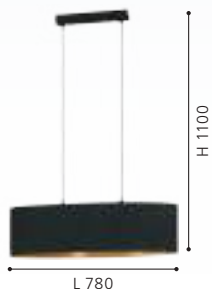

**900148 ZARAGOZA**

pendant light; steel, black / fabric with decoration, black, gold  
 Hängeleuchte; Stahl, schwarz / Textil mit Dekor, schwarz, gold  
 luminaire en suspension; acier, noir / tissu avec décor, noir, or

L 925, B 160, H 1100

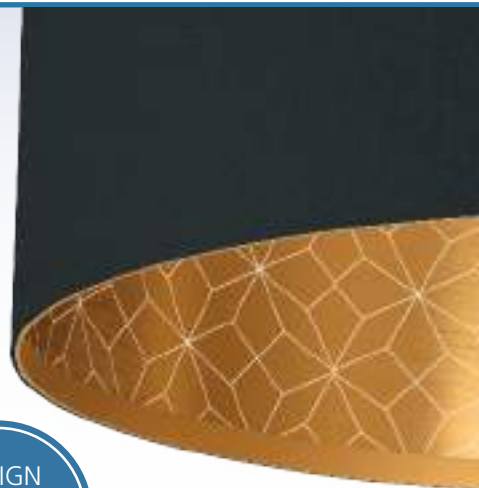



**900634**

**900634 BUCAMARANGA**

ceiling light; steel, white / fabric with decoration, white, gold  
Deckenleuchte; Stahl, weiss / Textil mit Dekor, weiss, gold  
plafonnier; acier, blanc / tissu avec décor, blanc, or

H 240, Ø 475



E27 1x 40W



9 008606 241200



**900635 BUCAMARANGA**

pendant light; steel, white / fabric with decoration, white, gold  
Hängeleuchte; Stahl, weiss / Textil mit Dekor, weiss, gold  
luminaire en suspension; acier, blanc / tissu avec décor, blanc, or

H 1100, Ø 530



E27 1x 40W



9 008606 241217





900635





31601



99543

LED



31606

### 31601 MASERLO

pendant light; steel, satin nickel / fabric, grey, silver  
 Hängeleuchte; Stahl, nickel-matt / Textil, grau, silber  
 luminaire en suspension; acier, nickel mat / tissu, gris, argent

H 1100, Ø 380



9 002759 316013



### 31606 MASERLO

pendant light; steel, satin nickel / fabric, grey, silver  
 Hängeleuchte; Stahl, nickel-matt / Textil, grau, silber  
 luminaire en suspension; acier, nickel mat / tissu, gris, argent

H 1100, Ø 530



9 002759 316068



### 99543 MASERLO 2

ceiling light; plastic, steel, white / fabric, grey, silver  
 Deckenleuchte; Kunststoff, Stahl, weiss / Textil, grau, silber  
 plafonnier; plastique, acier, blanc / tissu, gris, argent

H 90, Ø 380



9 002759 995430





95173



### 95173 MASERLO

floor light; steel, satin nickel / fabric, grey, silver  
Stehleuchte; Stahl, nickel-matt / Textil, grau, silber  
lampadaire; acier, nickel mat / tissu, gris, argent

H 1510, Ø 380, Base: Ø 250



E27



1x 60W



9 002759 951733

Ø 380



H 1510

Ø 250



99042



99043

**99042 MASERLO 1**

pendant light; steel, black / fabric, black  
 Hängeleuchte; Stahl, schwarz / Textil, schwarz  
 luminaire en suspension; acier, noir / tissu, noir

H 1100, Ø 380



E27 1x 40W



9 002759 990428



**99043 MASERLO 1**

pendant light; steel, black / fabric, black  
 Hängeleuchte; Stahl, schwarz / Textil, schwarz  
 luminaire en suspension; acier, noir / tissu, noir

H 1100, Ø 530

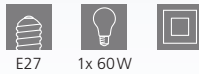

E27 1x 60W



9 002759 990435



**99045 MASERLO 1**

table light; steel, black / fabric, black  
 Tischleuchte; Stahl, schwarz / Textil, schwarz  
 luminaire de table; acier, noir / tissu, noir

H 415, Ø 230, Base: Ø 145

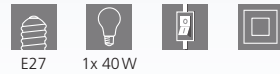

E27 1x 40W



9 002759 990459







MASERLO 1



99045

### 99046 MASERLO 1

floor light; steel, black / fabric, black  
Stehleuchte; Stahl, schwarz / Textil, schwarz  
lampadaire; acier, noir / tissu, noir

H 1515, Ø 380, Base: Ø 250



E27



1x 40W



9 002759 990466



99046



**31611**



**31616**



### 31611 MASERLO

pendant light; steel, satin nickel / fabric, black, gold  
Hängeleuchte; Stahl, nickel-matt / Textil, schwarz, gold  
luminaire en suspension; acier, nickel mat / tissu, noir, or

L 780, B 220, H 1100



E27 2x 60W

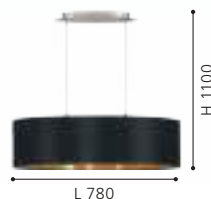

### 31616 MASERLO

pendant light; steel, satin nickel / fabric, black, gold  
Hängeleuchte; Stahl, nickel-matt / Textil, schwarz, gold  
luminaire en suspension; acier, nickel mat / tissu, noir, or

L 1000, B 250, H 1100



E27 2x 60W

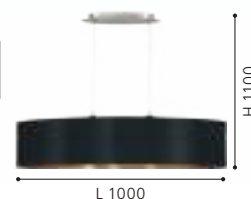



**31599**



**31605**

### 31599 MASERLO

pendant light; steel, satin nickel / fabric, black, gold  
 Hängeleuchte; Stahl, nickel-matt / Textil, schwarz, gold  
 luminaire en suspension; acier, nickel mat / tissu, noir, or

H 1100, Ø 380

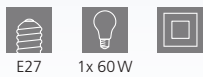

E27 1x 60W



9 002759 315993



### 31605 MASERLO

pendant light; steel, satin nickel / fabric, black, gold  
 Hängeleuchte; Stahl, nickel-matt / Textil, schwarz, gold  
 luminaire en suspension; acier, nickel mat / tissu, noir, or

H 1100, Ø 530



E27 3x 60W



9 002759 316051

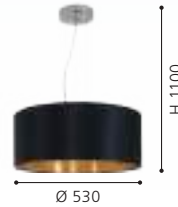



99539

LED



DESIGN  
HIGHLIGHT  
DETAIL



31627

### 99539 MASERLO 2

ceiling light; plastic, steel, white / fabric, black, gold  
Deckenleuchte; Kunststoff, Stahl, weiss / Textil, schwarz, gold  
plafonnier; plastique, acier, blanc / tissu, noir, or

H 90, Ø 380

LED

warm  
WHITE  
2400lm



9 002759 995393



### 31627 MASERLO

table light; steel, satin nickel / fabric, black, gold  
Tischleuchte; Stahl, nickel-matt / Textil, schwarz, gold  
luminaire de table; acier, nickel mat / tissu, noir, or

H 420, Ø 230, Base: Ø 145



E27



1x 60W



9 002759 316273



### 95169 MASERLO

floor light; steel, satin nickel / fabric, black, gold  
Stehleuchte; Stahl, nickel-matt / Textil, schwarz, gold  
lampadaire; acier, nickel mat / tissu, noir, or

H 1510, Ø 380, Base: Ø 250



E27



1x 60W



9 002759 951696

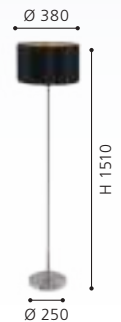



95169



**31618**

**31613**

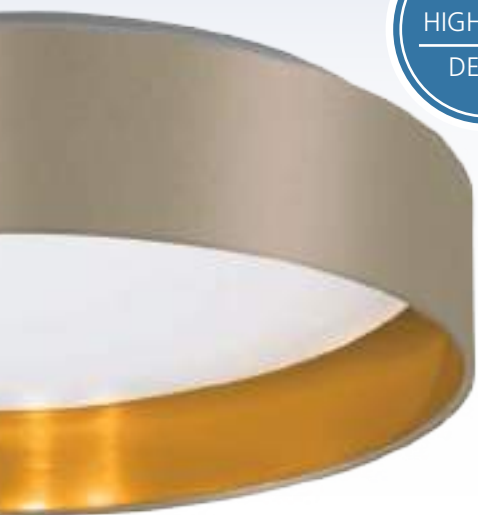

**31618 MASERLO**

pendant light; steel, satin nickel / fabric, taupe, gold  
 Hängeleuchte; Stahl, nickel-matt / Textil, taupe, gold  
 luminaire en suspension; acier, nickel mat / tissu, taupe, or

L 1000, B 250, H 1100

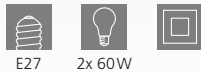

9 002759 316181

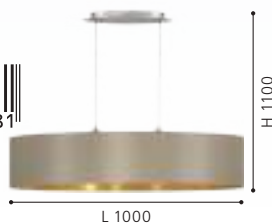

**31613 MASERLO**

pendant light; steel, satin nickel / fabric, taupe, gold  
 Hängeleuchte; Stahl, nickel-matt / Textil, taupe, gold  
 luminaire en suspension; acier, nickel mat / tissu, taupe, or

L 780, B 220, H 1100

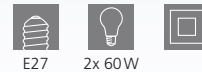

9 002759 316136

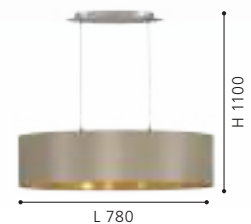



31602

99541

LED



31607

### 31602 MASERLO

pendant light; steel, satin nickel / fabric, taupe, gold  
Hängeleuchte; Stahl, nickel-matt / Textil, taupe, gold  
luminaire en suspension; acier, nickel mat / tissu, taupe, or

H 1100, Ø 380

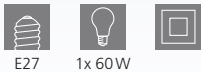

E27 1x 60W



9 002759 316020

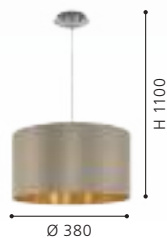

### 99541 MASERLO 2

ceiling light; plastic, steel, white / fabric, taupe, gold  
Deckenleuchte; Kunststoff, Stahl, weiss / Textil, taupe, gold  
plafonnier; plastique, acier, blanc / tissu, taupe, or

H 90, Ø 380



LED 20W 2400lm



9 002759 995416

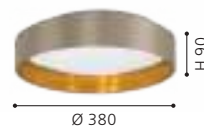

### 31607 MASERLO

pendant light; steel, satin nickel / fabric, taupe, gold  
Hängeleuchte; Stahl, nickel-matt / Textil, taupe, gold  
luminaire en suspension; acier, nickel mat / tissu, taupe, or

H 1100, Ø 530



E27 3x 60W



9 002759 316075

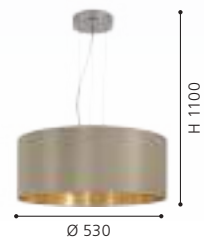



95055



95055

The diffuser on the top ensures harmonious light distribution.

Der Diffusor auf der Oberseite sorgt für eine harmonische Lichtverteilung.

Le diffuseur situé sur le dessus assure une répartition harmonieuse de la lumière.



31629



95171

### 95055 MASERLO

wall light; steel, satin nickel / fabric, taupe, gold  
Wandleuchte; Stahl, nickel-matt / Textil, taupe, gold  
Applique; acier, nickel mat / tissu, taupe, or

H 260, Ø 230, A 595



E27

1x 60W



9 002759 950552

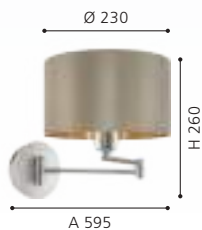

### 31629 MASERLO

table light; steel, satin nickel / fabric, taupe, gold  
Tischleuchte; Stahl, nickel-matt / Textil, taupe, gold  
luminaire de table; acier, nickel mat / tissu, taupe, or

H 420, Ø 230, Base: Ø 145



E27

1x 60W



9 002759 316297



### 95171 MASERLO

floor light; steel, satin nickel / fabric, taupe, gold  
Stehleuchte; Stahl, nickel-matt / Textil, taupe, gold  
lampadaire; acier, nickel mat / tissu, taupe, or

H 1510, Ø 380, Base: Ø 250



E27

1x 60W



9 002759 951719

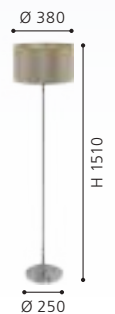





31614



31603



### 31614 MASERLO

pendant light; steel, satin nickel / fabric, cappuccino, gold  
 Hängeleuchte; Stahl, nickel-matt / Textil, cappuccino, gold  
 luminaire en suspension; acier, nickel mat / tissu, cappucino, or

L 780, B 220, H 1100

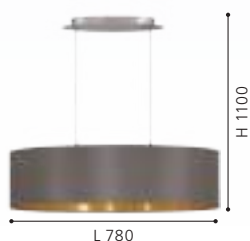
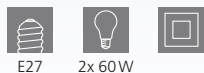

### 31603 MASERLO

pendant light; steel, satin nickel / fabric, cappuccino, gold  
 Hängeleuchte; Stahl, nickel-matt / Textil, cappuccino, gold  
 luminaire en suspension; acier, nickel mat / tissu, cappucino, or

H 1100, Ø 380

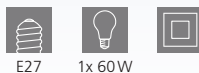



99542

LED



31608

### 99542 MASERLO 2

ceiling light; plastic, steel, white / fabric, cappuccino, gold  
Deckenleuchte; Kunststoff, Stahl, weiss / Textil, cappuccino, gold  
plafonnier; plastique, acier, blanc / tissu, cappuccino, or

H 90, Ø 380



20W



2400lm



9 002759 995423

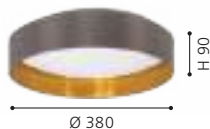

### 31608 MASERLO

pendant light; steel, satin nickel / fabric, cappuccino, gold  
Hängeleuchte; Stahl, nickel-matt / Textil, cappuccino, gold  
luminaire en suspension; acier, nickel mat / tissu, cappuccino, or

H 1100, Ø 530



E27



3x 60W



9 002759 316082



### 31631 MASERLO

table light; steel, satin nickel / fabric, cappuccino, gold  
Tischleuchte; Stahl, nickel-matt / Textil, cappuccino, gold  
luminaire de table; acier, nickel mat / tissu, cappuccino, or

H 420, Ø 230, Base: Ø 145



E27



1x 60W



9 002759 316310





31631

### 95172 MASERLO

floor light; steel, satin nickel / fabric, cappuccino, gold  
Stehleuchte; Stahl, nickel-matt / Textil, cappuccino, gold  
lampadaire; acier, nickel mat / tissu, cappuccino, or

H 1510, Ø 380, Base: Ø 250



E27



1x 60W



9 002759 951726

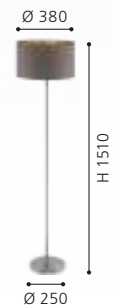

95172



**97684**

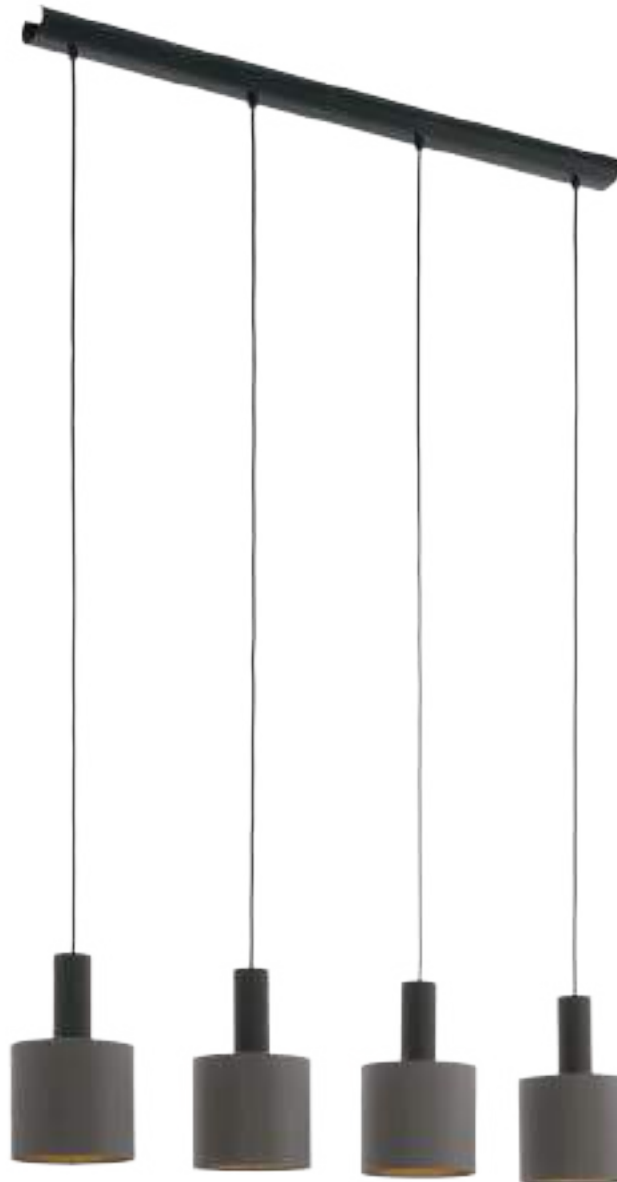

**97685**

### 97684 CONCESSA 1

pendant light; steel, dark brown / fabric, cappuccino, gold  
 Hängeleuchte; Stahl, dunkelbraun / Textil, cappuccino, gold  
 luminaire en suspension; acier, marron foncé / tissu, cappuccino, or

H 1500, Ø 420



9 002759 976842



### 97685 CONCESSA 1

pendant light; steel, dark brown / fabric, cappuccino, gold  
 Hängeleuchte; Stahl, dunkelbraun / Textil, cappuccino, gold  
 luminaire en suspension; acier, marron foncé / tissu, cappuccino, or

L 940, B 160, H 1500



9 002759 976859

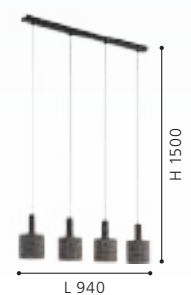



97683



97682

**97683 CONCESSA 1**

pendant light; steel, dark brown / fabric, cappuccino, gold  
 Hängeleuchte; Stahl, dunkelbraun / Textil, cappuccino, gold  
 luminaire en suspension; acier, marron foncé / tissu, cappuccino, or

H 1500, Ø 530



**97682 CONCESSA 1**

pendant light; steel, dark brown / fabric, cappuccino, gold  
 Hängeleuchte; Stahl, dunkelbraun / Textil, cappuccino, gold  
 luminaire en suspension; acier, marron foncé / tissu, cappuccino, or

H 1500, Ø 380

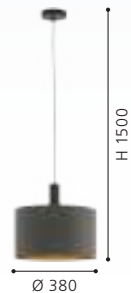
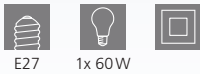

DESIGN  
HIGHLIGHT  
DETAIL



99445



99446



### 99445 ALBARIZA

pendant light; steel, wood, black, brown / fabric, cappuccino, gold

Hängeleuchte; Stahl, Holz, schwarz, braun / Textil, cappuccino, gold

luminaire en suspension; acier, bois, noir, marron / tissu, cappuccino, or

H 1100, Ø 160



E27

1x 40W



9 002759 994457

### 99446 ALBARIZA

pendant light; steel, wood, black, brown / fabric, cappuccino, gold

Hängeleuchte; Stahl, Holz, schwarz, braun / Textil, cappuccino, gold

luminaire en suspension; acier, bois, noir, marron / tissu, cappuccino, or

L 895, B 160, H 1100



E27

3x 40W



9 002759 994464

### 99447 ALBARIZA

pendant light; steel, wood, black, brown / fabric, cappuccino, gold

Hängeleuchte; Stahl, Holz, schwarz, braun / Textil, cappuccino, gold

luminaire en suspension; acier, bois, noir, marron / tissu, cappuccino, or

H 1500, Ø 700



E27

5x 40W



9 002759 994471



99447





900861



900861

### 900861 FENIGLIA

table light; steel, black / fabric, linen, natural  
Tischleuchte; Stahl, schwarz / Textil, Leinen, natur  
luminaire de table; acier, noir / tissu, lin, nature

H 255, Ø 120, Base: Ø 120



E27



1x 40W



9 008606 274420







**900859**



**900858**



EGLO  
RECOMMENDS  
**110042**

900858



EGLO  
RECOMMENDS  
**110038**

900859 | 900862

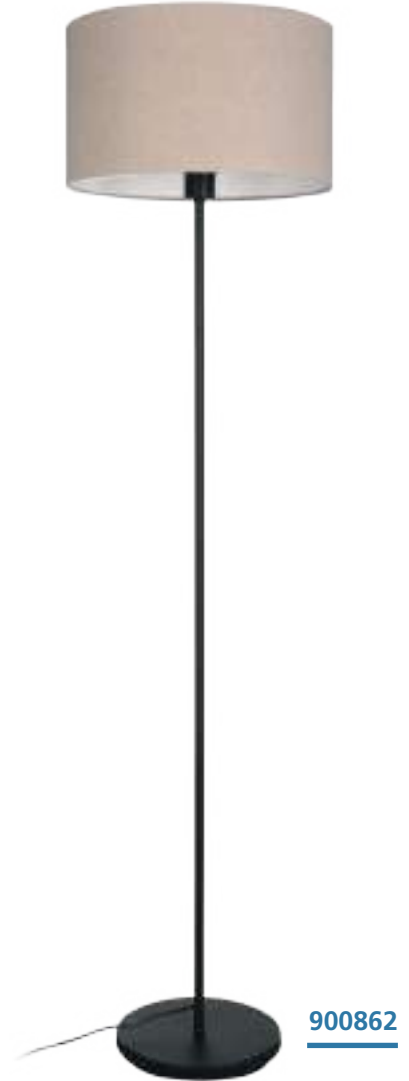

**900862**

### 900859 FENIGLIA

pendant light; steel, black / fabric, linen, natural  
Hängeleuchte; Stahl, schwarz / Textil, Leinen, natur  
luminaire en suspension; acier, noir / tissu, lin, nature

H 1100, Ø 380



E27 1x 40W



9 008606 274413



### 900858 FENIGLIA

ceiling light; steel, black / fabric, linen, natural  
Deckenleuchte; Stahl, schwarz / Textil, Leinen, natur  
plafonnier; acier, noir / tissu, lin, nature

H 240, Ø 475



E27 1x 40W



9 008606 274406



### 900862 FENIGLIA

floor light; steel, black / fabric, linen, natural  
Stehleuchte; Stahl, schwarz / Textil, Leinen, natur  
lampadaire; acier, noir / tissu, lin, nature

H 1510, Ø 380, Base: Ø 250

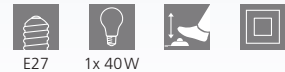

E27 1x 40W



9 008606 274437

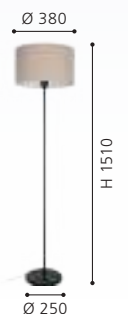



### 99487 ALMEIDA 2

pendant light; steel, brushed brass / fabric, cappuccino, brass  
 Hängeleuchte; Stahl, messing-gebürstet / Textil, cappuccino, messing  
 luminaire en suspension; acier, laiton brossé / tissu, cappuccino, laiton

L 1200, B 155, H 1100



E14 5x 40W



9 002759 994877

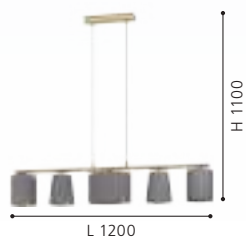

### 99486 ALMEIDA 2

ceiling light; steel, brushed brass / fabric, cappuccino, brass  
 Deckenleuchte; Stahl, messing-gebürstet / Textil, cappuccino, messing  
 plafonnier; acier, laiton brossé / tissu, cappuccino, laiton

L 810, B 155, H 280



E14 3x 40W



9 002759 994860

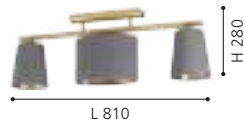

### 99612 ALMEIDA 2

floor light; steel, brushed brass / fabric, cappuccino, brass  
 Stehleuchte; Stahl, messing-gebürstet / Textil, cappuccino, messing  
 lampadaire; acier, laiton brossé / tissu, cappuccino, laiton

H 1670, Ø 320, Base: Ø 300

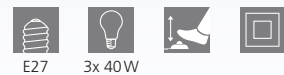

E27 3x 40W



9 002759 996123





99612

### 99611 ALMEIDA 2

table light; steel, brushed brass / fabric, cappuccino, brass  
Tischleuchte; Stahl, messing-gebürstet / Textil, cappuccino, messing  
luminaire de table; acier, laiton brossé / tissu, cappuccino, laiton

H 605, Ø 260, Base: Ø 200



E27



2x 40W



9 002759 996116



99611

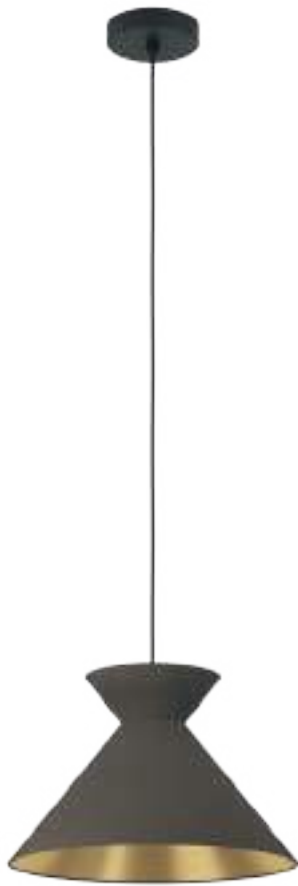

**900347**



**900348**



DESIGN  
HIGHLIGHT  
DETAIL

**900347 NASTASIA**

pendant light; steel, black / fabric, cappuccino, brass  
Hängeleuchte; Stahl, schwarz / Textil, cappuccino, messing  
luminaire en suspension; acier, noir / tissu, cappuccino, laiton

H 1100, Ø 380



**900348 NASTASIA**

pendant light; steel, black / fabric, cappuccino, brass  
Hängeleuchte; Stahl, schwarz / Textil, cappuccino, messing  
luminaire en suspension; acier, noir / tissu, cappuccino, laiton

L 1000, B 240, H 1100





### 900376 AGLIENTINA

pendant light; steel, brushed brass / fabric, white, brass  
 Hängeleuchte; Stahl, messing-gebürstet / Textil, weiss, messing  
 luminaire en suspension; acier, laiton brossé / tissu, blanc, laiton

H 1100, Ø 200

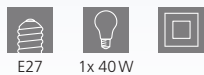

E27 1x 40W



9 008606 243587



### 900378 AGLIENTINA

floor light; steel, brushed brass / fabric, white, brass  
 Stehleuchte; Stahl, messing-gebürstet / Textil, weiss, messing  
 lampadaire; acier, laiton brossé / tissu, blanc, laiton

H 1700, Ø 200, Base: Ø 250



E27 1x 40W



9 008606 243600



### 900377 AGLIENTINA

pendant light; steel, brushed brass / fabric, white, brass  
 Hängeleuchte; Stahl, messing-gebürstet / Textil, weiss, messing  
 luminaire en suspension; acier, laiton brossé / tissu, blanc, laiton

L 900, B 200, H 1100



E27 3x 40W



9 008606 243594





### 98587 ALMEIDA 1

pendant light; steel, black / fabric, grey, white  
 Hängeleuchte; Stahl, schwarz / Textil, grau, weiss  
 luminaire en suspension; acier, noir / tissu, gris, blanc

L 860, B 255, H 1100



### 98588 ALMEIDA 1

pendant light; steel, black / fabric, black, grey, white  
 Hängeleuchte; Stahl, schwarz / Textil, schwarz, grau, weiss  
 luminaire en suspension; acier, noir / tissu, noir, gris, blanc

L 1200, B 255, H 1100





95192



95194



94995

### 95192 ALMEIDA

ceiling light; steel, black / fabric, anthracite, white, brown  
Deckenleuchte; Stahl, schwarz / Textil, anthrazit, weiss, braun  
plafonnier; acier, noir / tissu, anthracite, blanc, marron

H 350, Ø 590



E14 3x 40W



9 002759 951924

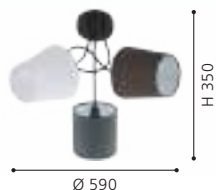

### 95194 ALMEIDA

table light; steel, black / fabric, white, anthracite  
Tischleuchte; Stahl, schwarz / Textil, weiss, anthrazit  
luminaire de table; acier, noir / tissu, blanc, anthracite

L 380, B 185, H 475, Base: Ø 155



E14 2x 40W



9 002759 951948



### 94995 MARONDA

floor light; steel, black / fabric, anthracite, white, brown  
Stehleuchte; Stahl, schwarz / Textil, anthrazit, weiss, braun  
lampadaire; acier, noir / tissu, anthracite, blanc, marron

L 275, B 35, H 1520, Base: Ø 230



E14 3x 40W



9 002759 949952

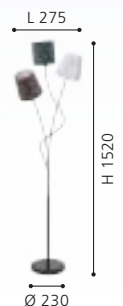

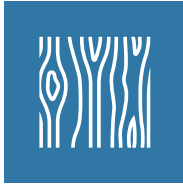

# LIGHTING FAMILIES / WOOD LUMINAIRES

LEUCHTENFAMILIEN / HOLZLEUCHTEN  
FAMILLES DE LUMINAIRES / LUMINAIRES À BOIS



## EN **SIMPLE CLASSINESS**

The wood luminaires with their unusual designs are perfectly trendy and bring cosiness to every home. Our range of wood luminaires offers a great selection of various shapes, sizes and colours. It contains anything from suspended to table luminaires.

## DE **SCHLICHTE ELEGANZ**

Die Holzleuchten mit ihrem außergewöhnlichen Design sind voll im Trend und sorgen für Gemütlichkeit in jedem Zuhause. Unser Sortiment an Holzleuchten bietet eine große Auswahl an verschiedenen Formen, Größen sowie Farben und reicht von der Hänge- bis hin zur Tischleuchte.

## FR **ÉLÉGANCE SIMPLE**

Les luminaires en bois avec leur design extraordinaire sont très tendance et assurent un confort dans chaque maison. Notre gamme de luminaires en bois offre un grand choix de formes, de tailles et de couleurs différentes et s'étend des luminaires en suspension jusqu'aux luminaires de table.







# OVERVIEW

LIGHTING FAMILIES / WOOD LUMINAIRES  
LEUCHTENFAMILIEN / HOLZLEUCHTEN  
FAMILLES DE LUMINAIRES / LUMINAIRES À BOIS



This product is available in different colors and shapes. / Dieser Artikel ist in unterschiedlichen Farben und Formen verfügbar. /  
Cet article est disponible en différentes couleurs et formes.

# WOOD MATERIALS

HOLZ MATERIALIEN / MATÉRIAUX EN BOIS

## LAMELLA SHADES / LAMELENSCHIRME / OMBRES À LAMELLES



wood, white  
Holz, weiß  
bois, blanc



wood, brown  
Holz, braun  
bois, marron



wood, maple  
Holz, ahorn  
bois, érable



wood, maple  
Holz, ahorn  
bois, érable

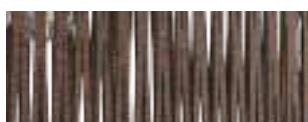

wood, brown  
Holz, braun  
bois, marron



wood, black  
Holz, schwarz  
bois, noir



wood, grey  
Holz, grau  
bois, gris



wood, nut  
Holz, nuss  
bois, noix

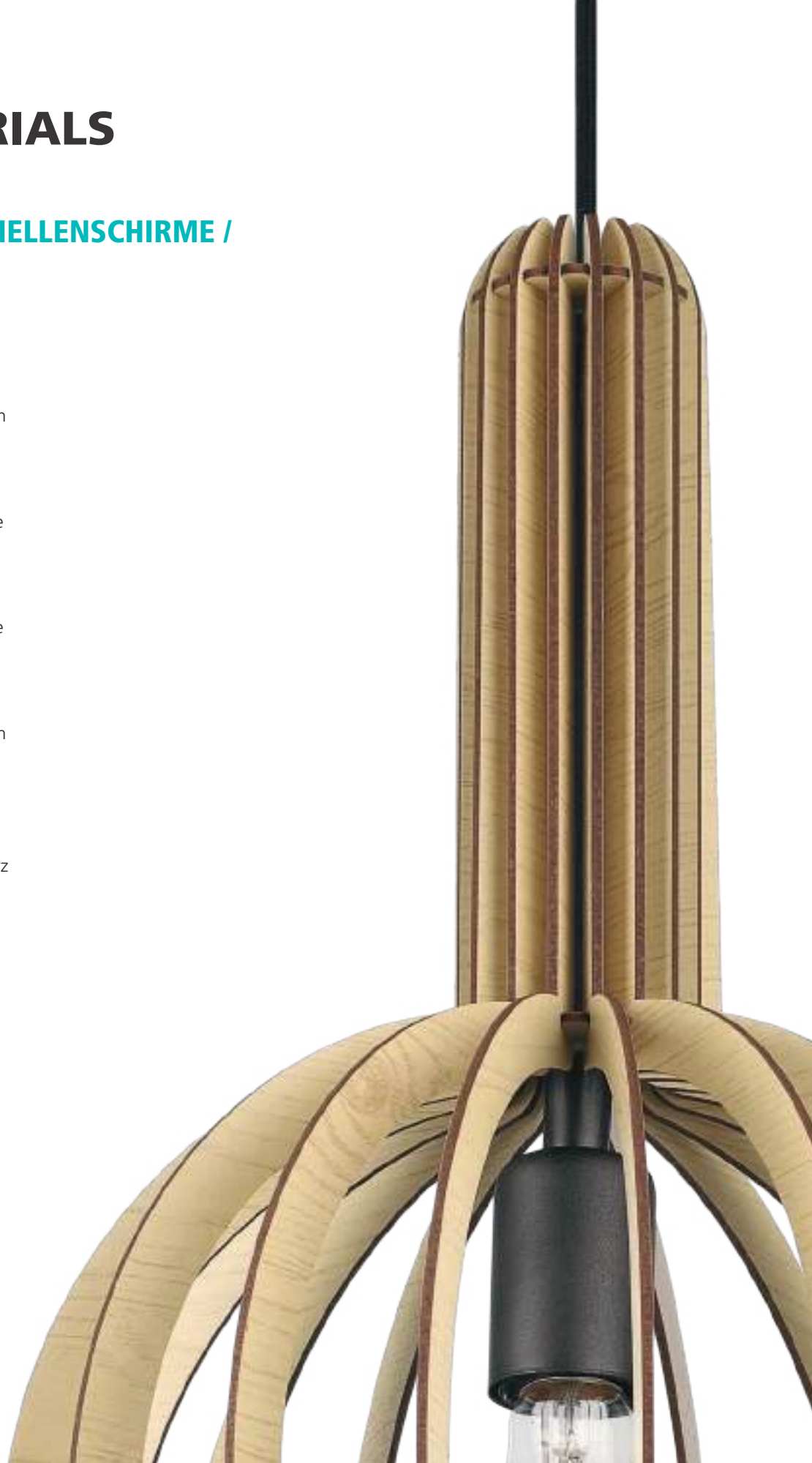

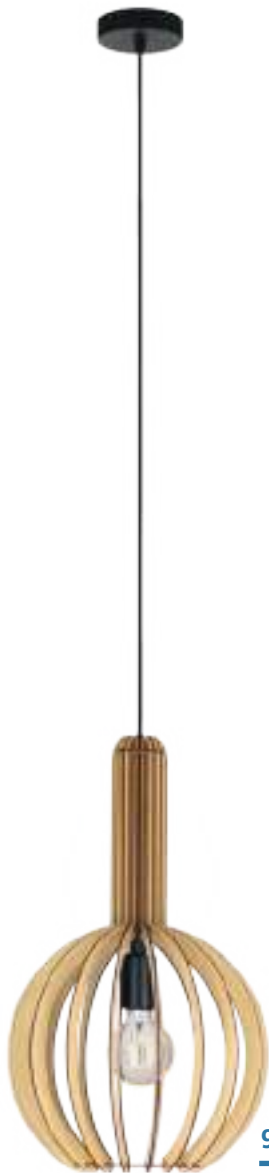

**900151**



**900152**



**900153**

### 900151 VELASCO

pendant light; steel, black / wood, maple  
 Hängeleuchte; Stahl, schwarz / Holz, ahorn  
 luminaire en suspension; acier, noir / bois, érable

H 1100, Ø 310

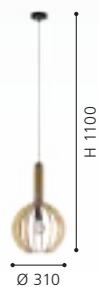

### 900152 VELASCO

pendant light; steel, black / wood, maple  
 Hängeleuchte; Stahl, schwarz / Holz, ahorn  
 luminaire en suspension; acier, noir / bois, érable

H 1100, Ø 380



### 900153 VELASCO

pendant light; steel, black / wood, black  
 Hängeleuchte; Stahl, schwarz / Holz, schwarz  
 luminaire en suspension; acier, noir / bois, noir

H 1100, Ø 310

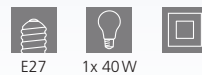



**900154**

### 900154 VELASCO

pendant light; steel, black / wood, black  
Hängeleuchte; Stahl, schwarz / Holz, schwarz  
luminaire en suspension; acier, noir / bois, noir

H 1100, Ø 380



E27



1x 40W



9 008606 224074





**900503**



**900502**

**900503 BAJAZZARA**

pendant light; steel, black / wood, grey  
 Hängeleuchte; Stahl, schwarz / Holz, grau  
 luminaire en suspension; acier, noir / bois, gris

L 890, B 190, H 1100



**900502 BAJAZZARA**

pendant light; steel, black / wood, grey  
 Hängeleuchte; Stahl, schwarz / Holz, grau  
 luminaire en suspension; acier, noir / bois, gris

H 1100, Ø 260

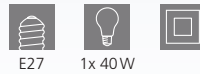



**900505**



**900504**

### 900505 BAJAZZARA

pendant light; steel, black / wood, black  
 Hängeleuchte; Stahl, schwarz / Holz, schwarz  
 luminaire en suspension; acier, noir / bois, noir

L 890, B 190, H 1100

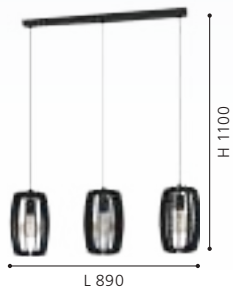

### 900504 BAJAZZARA

pendant light; steel, black / wood, black  
 Hängeleuchte; Stahl, schwarz / Holz, schwarz  
 luminaire en suspension; acier, noir / bois, noir

H 1100, Ø 260





**900739**



### SEGOVIA

Due to the arrangement of the superimposed rings, glare from the light sources is prevented.

Aufgrund der Anordnung der übereinander liegenden Ringe wird das Blendens durch die Leuchtmittel verhindert.

Grâce à la disposition des anneaux superposés, l'éblouissement par les lampes est évité.

### 900739 SEGOVIA

spot; steel, black / wood, black  
Spot; Stahl, schwarz / Holz, schwarz  
spot; acier, noir / bois, noir

L 130, H 195, A 175



E27



1x 40W

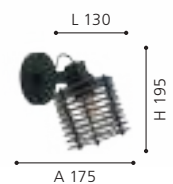





900741



900742



900738



900739 | 900741 | 900742



900738

### 900741 SEGOVIA

spot; steel, black / wood, black  
Spot; Stahl, schwarz / Holz, schwarz  
spot; acier, noir / bois, noir

L 335, H 185, A 175



E27 2x 40W



9 008606 267156



L 335

H 185

### 900742 SEGOVIA

spot; steel, black / wood, black  
Spot; Stahl, schwarz / Holz, schwarz  
spot; acier, noir / bois, noir

L 575, H 185, A 175



E27 3x 40W



9 008606 267163



L 575

H 185

### 900738 SEGOVIA

pendant light; steel, black / wood, black  
Hängeleuchte; Stahl, schwarz / Holz, schwarz  
luminaire en suspension; acier, noir / bois, noir

L 880, B 180, H 1100



E27 3x 40W



9 008606 267132

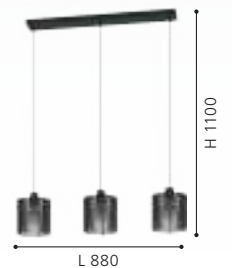

L 880

H 1100



**900831**

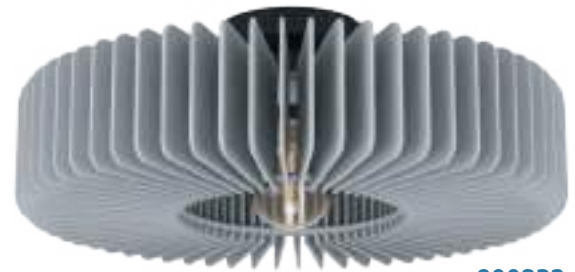

**900832**



**900831 PALOMBAIA**

ceiling light; steel, black / wood, black  
Deckenleuchte; Stahl, schwarz / Holz, schwarz  
plafonnier; acier, noir / bois, noir

H 175, Ø 500



E27



1x 40W



9 008606 274024



**900832 PALOMBAIA**

ceiling light; steel, black / wood, grey  
Deckenleuchte; Stahl, schwarz / Holz, grau  
plafonnier; acier, noir / bois, gris

H 175, Ø 500



E27



1x 40W



9 008606 274031



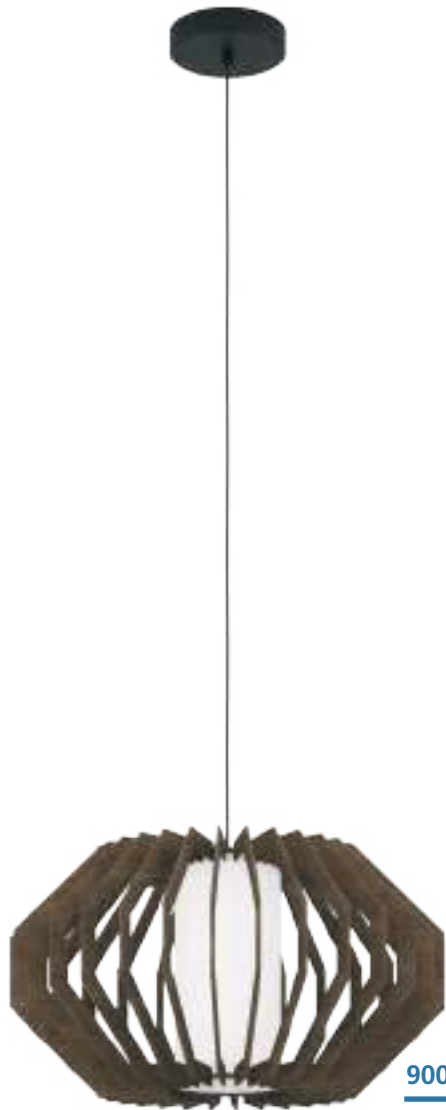

**900386**



**900385**

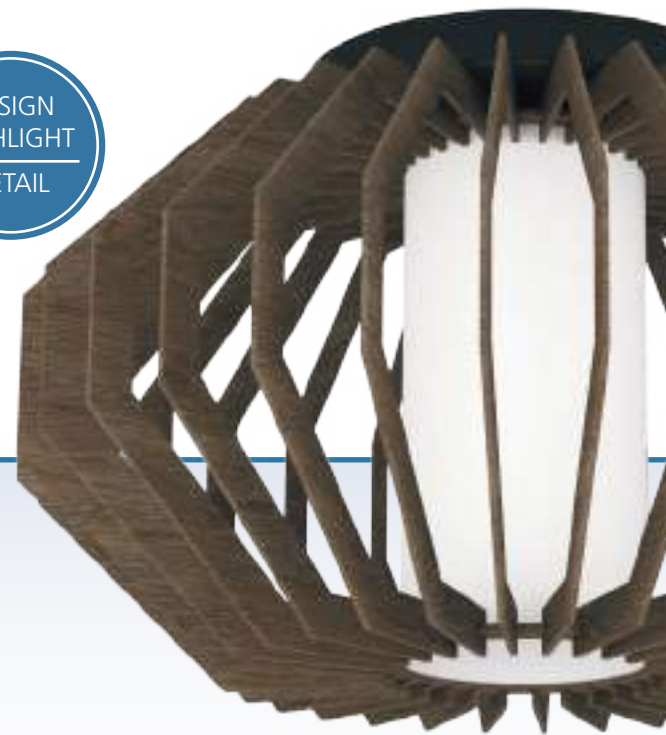

### 900386 RUSTICARIA

pendant light; steel, black / wood, glass, brown, white  
Hängeleuchte; Stahl, schwarz / Holz, Glas, braun, weiss  
luminaire en suspension; acier, noir / bois, verre, marron, blanc

H 1100, Ø 450



### 900385 RUSTICARIA

ceiling light; steel, black / wood, glass, brown, white  
Deckenleuchte; Stahl, schwarz / Holz, Glas, braun, weiss  
plafonnier; acier, noir / bois, verre, marron, blanc

H 275, Ø 450





**900904**

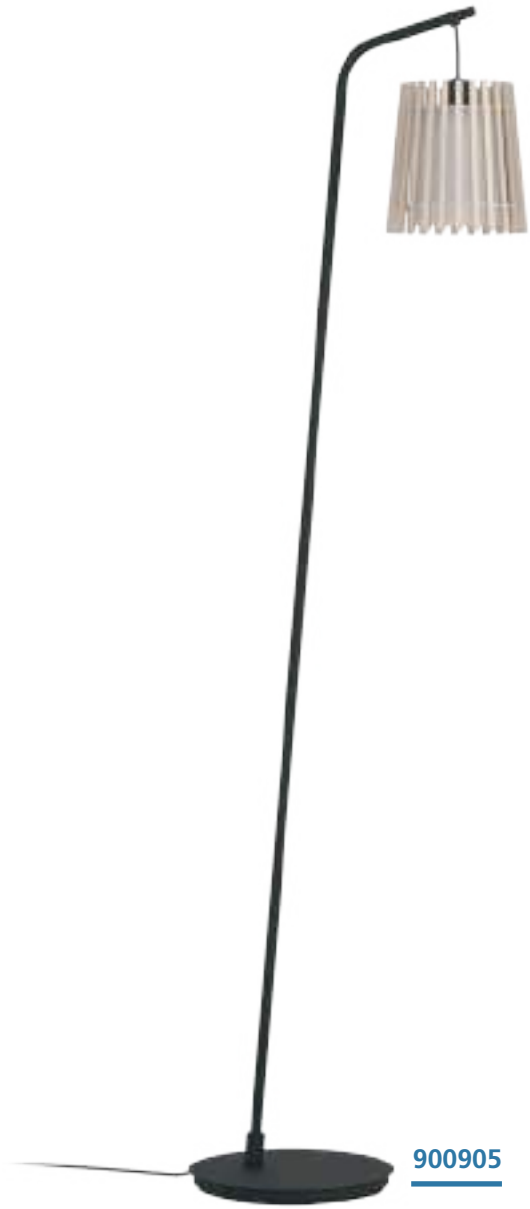

**900905**

### 900904 FATTORIA

table light; steel, black / wood, fabric, brown, white  
 Tischleuchte; Stahl, schwarz / Holz, Textil, braun, weiss  
 luminaire de table; acier, noir / bois, tissu, marron, blanc

H 450, Ø 200, Base: Ø 180

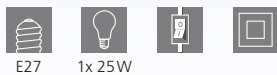

### 900905 FATTORIA

floor light; steel, black / wood, fabric, brown, white  
 Stehleuchte; Stahl, schwarz / Holz, Textil, braun, weiss  
 lampadaire; acier, noir / bois, tissu, marron, blanc

L 495, B 200, H 1700, Base: Ø 300

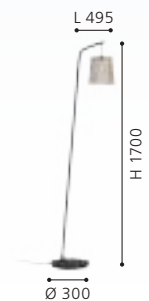

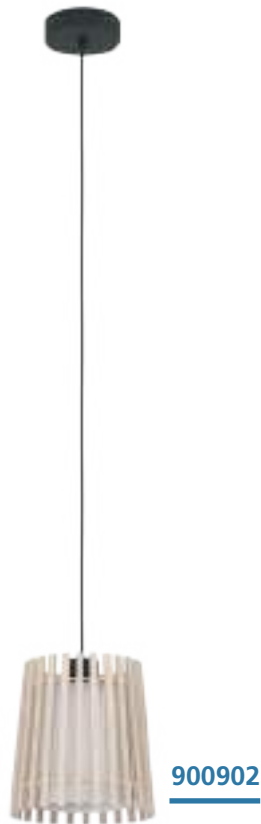

**900902**



900901



**900901**



**900903**



900905 | 900902



900903 | 900904

### 900902 FATTORIA

pendant light; steel, black / wood, fabric, brown, white  
Hängeleuchte; Stahl, schwarz / Holz, Textil, braun, weiss  
luminaire en suspension; acier, noir / bois, tissu, marron, blanc

H 1100, Ø 200



E27 1x 25W



9 008606 274727



### 900903 FATTORIA

pendant light; steel, black / wood, fabric, brown, white  
Hängeleuchte; Stahl, schwarz / Holz, Textil, braun, weiss  
luminaire en suspension; acier, noir / bois, tissu, marron, blanc

L 900, B 200, H 1100



E27 3x 25W



9 008606 274734



### 900901 FATTORIA

ceiling light; steel, black / wood, fabric, brown, white  
Deckenleuchte; Stahl, schwarz / Holz, Textil, braun, weiss  
plafonnier; acier, noir / bois, tissu, marron, blanc

H 240, Ø 380

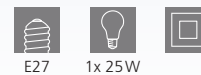

E27 1x 25W



9 008606 274710

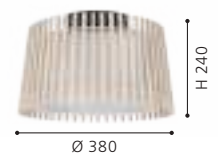



**900847**



**95597**



**95602**

### 900847 MATTANZA

pendant light; steel, black / wood, grey  
Hängeleuchte; Stahl, schwarz / Holz, grau  
luminaire en suspension; acier, noir / bois, gris

H 2465, Ø 495



E27 1x 40W



9 008606 274147



### 95597 STELLATO 1

ceiling light; steel, satin nickel / wood, glass, maple, white  
Deckenleuchte; Stahl, nickel-matt / Holz, Glas, ahorn, weiss  
plafonnier; acier, nickel mat / bois, verre, érable, blanc

H 275, Ø 400



E27 1x 60W



9 002759 955977

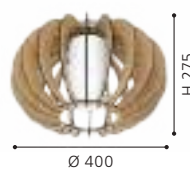

### 95602 STELLATO 1

wall light; steel, white / wood, glass, maple, white  
Wandleuchte; Stahl, weiss / Holz, Glas, ahorn, weiss  
Applique; acier, blanc / bois, verre, érable, blanc

L 285, H 250, A 140



E27 1x 60W



9 002759 956028

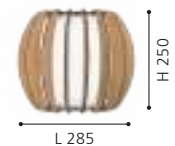



EGLO  
RECOMMENDS  
**110033**

STELLATO 1  
STELLATO 2

### 95598 STELLATO 1

pendant light; steel, satin nickel / wood, glass, maple, white  
Hängeleuchte; Stahl, nickel-matt / Holz, Glas, ahorn, weiss  
luminaire en suspension; acier, nickel mat / bois, verre, érable, blanc

H 1300, Ø 400

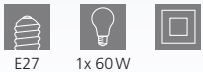

### 95591 STELLATO 3

pendant light; steel, satin nickel / wood, glass, brown, white  
Hängeleuchte; Stahl, nickel-matt / Holz, Glas, braun, weiss  
luminaire en suspension; acier, nickel mat / bois, verre, marron, blanc

H 1300, Ø 400



### 95606 STELLATO 2

pendant light; steel, white / wood, glass, white  
Hängeleuchte; Stahl, weiss / Holz, Glas, weiss  
luminaire en suspension; acier, blanc / bois, verre, blanc

H 1300, Ø 400

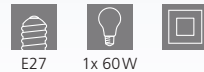



**96211**



**96257**

### 96211 TINDORI

pendant light; steel, satin nickel / wood, glass, white  
 Hängeleuchte; Stahl, nickel-matt / Holz, Glas, weiss  
 luminaire en suspension; acier, nickel mat / bois, verre, blanc

H 1500, Ø 500



E27



1x 60W



9 002759 962111



### 96257 TINDORI

pendant light; steel, satin nickel / wood, white  
 Hängeleuchte; Stahl, nickel-matt / Holz, weiss  
 luminaire en suspension; acier, nickel mat / bois, blanc

H 1300, Ø 380



E27



1x 60W



9 002759 962579







**96258**



**96214**



96211 | 96214

### 96258 TINDORI

pendant light; steel, satin nickel / wood, maple  
 Hängeleuchte; Stahl, nickel-matt / Holz, ahorn  
 luminaire en suspension; acier, nickel mat / bois, érable

H 1300, Ø 380

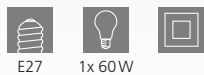

E27 1x 60W



9 002759 962586



### 96214 TINDORI

pendant light; steel, satin nickel / wood, glass, maple, white  
 Hängeleuchte; Stahl, nickel-matt / Holz, Glas, ahorn, weiss  
 luminaire en suspension; acier, nickel mat / bois, verre, érable, blanc

H 1500, Ø 500



E27 1x 60W



9 002759 962142



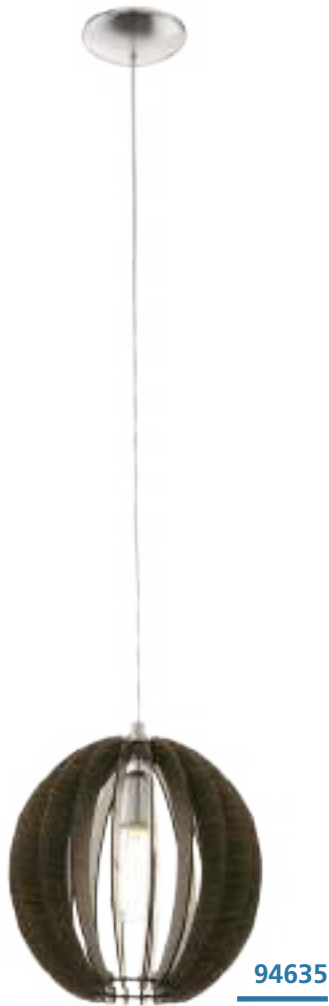

**94635**



**94636**



**95261**

**94635 COSSANO**

pendant light; steel, satin nickel / wood, brown  
 Hängeleuchte; Stahl, nickel-matt / Holz, braun  
 luminaire en suspension; acier, nickel mat / bois, marron

H 1300, Ø 300



E27 1x 60W



9 002759 946357



**94636 COSSANO**

pendant light; steel, satin nickel / wood, brown  
 Hängeleuchte; Stahl, nickel-matt / Holz, braun  
 luminaire en suspension; acier, nickel mat / bois, marron

H 1500, Ø 500

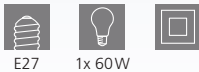

E27 1x 60W



9 002759 946364



**95261 COSSANO 2**

pendant light; steel, satin nickel / wood, dark brown  
 Hängeleuchte; Stahl, nickel-matt / Holz, dunkelbraun  
 luminaire en suspension; acier, nickel mat / bois, marron foncé

H 1500, Ø 500



E27 1x 60W



9 002759 952617



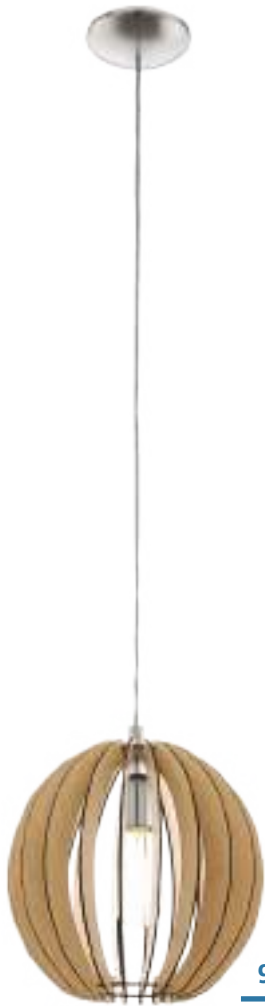

**94764**



**94765**

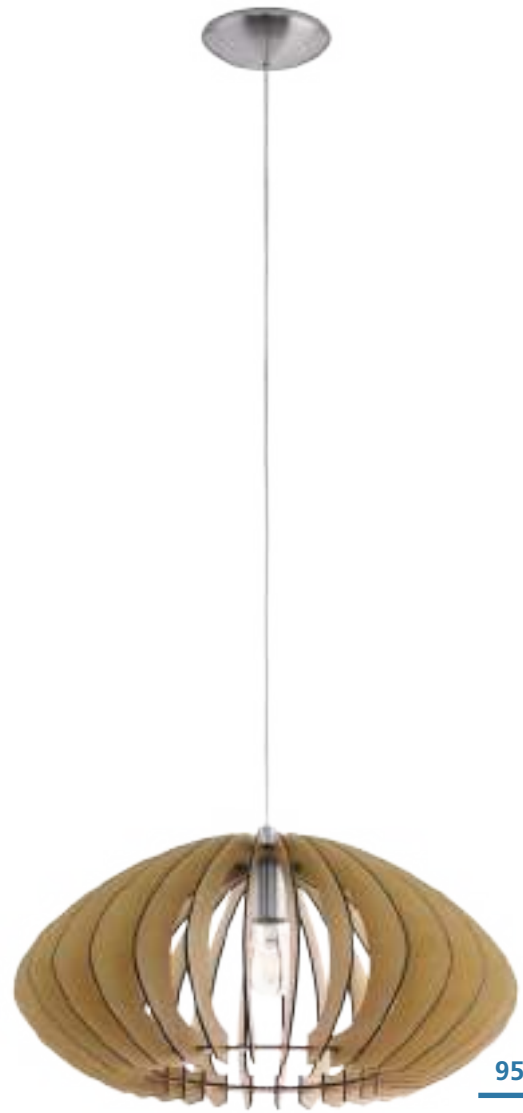

**95257**

**94764 COSSANO**

pendant light; steel, satin nickel / wood, maple  
 Hängeleuchte; Stahl, nickel-matt / Holz, ahorn  
 luminaire en suspension; acier, nickel mat / bois, érable

H 1300, Ø 300

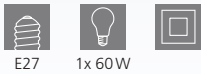

E27 1x 60W



9 002759 947644



**94765 COSSANO**

pendant light; steel, satin nickel / wood, maple  
 Hängeleuchte; Stahl, nickel-matt / Holz, ahorn  
 luminaire en suspension; acier, nickel mat / bois, érable

H 1500, Ø 500

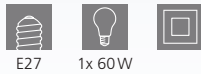

E27 1x 60W



9 002759 947651



**95257 COSSANO 2**

pendant light; steel, satin nickel / wood, maple  
 Hängeleuchte; Stahl, nickel-matt / Holz, ahorn  
 luminaire en suspension; acier, nickel mat / bois, érable

H 1500, Ø 500

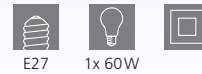

E27 1x 60W



9 002759 952570





**96194**



**96195**



**96193**

### 96194 SENDERO

pendant light; steel, satin nickel / wood, maple  
Hängeleuchte; Stahl, nickel-matt / Holz, ahorn  
luminaire en suspension; acier, nickel mat / bois, érable

L 775, B 250, H 1300



E27 2x 60W



9 002759 961947



### 96193 SENDERO

pendant light; steel, satin nickel / wood, maple  
Hängeleuchte; Stahl, nickel-matt / Holz, ahorn  
luminaire en suspension; acier, nickel mat / bois, érable

H 1300, Ø 450



E27 1x 60W



9 002759 961930



### 96195 SENDERO

wall light; steel, white / wood, maple  
Wandleuchte; Stahl, weiss / Holz, ahorn  
applique; acier, blanc / bois, érable

L 240, H 220, A 120

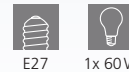

E27 1x 60W



9 002759 961954





**96199**



**96201**

### 96199 SENDERO

pendant light; steel, satin nickel / wood, brown  
 Hängeleuchte; Stahl, nickel-matt / Holz, braun  
 luminaire en suspension; acier, nickel mat / bois, marron

H 1300, Ø 450



E27 1x 60W



### 96201 SENDERO

pendant light; steel, satin nickel / wood, brown  
 Hängeleuchte; Stahl, nickel-matt / Holz, braun  
 luminaire en suspension; acier, nickel mat / bois, marron

L 775, B 250, H 1300

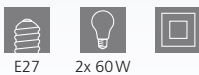

E27 2x 60W



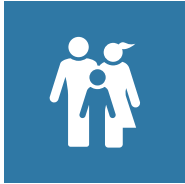

# LIGHTING FAMILIES / ESSENTIAL LUMINAIRES

LEUCHTENFAMILIEN / STANDARD LEUCHTEN  
FAMILLES DE LUMINAIRES / LUMINAIRES ESSENTIEL

## EN **FAMILY MEETING**

This range combines ceiling, wall, suspended, floor and table luminaires. Give your rooms a consistent and stylish all-round illumination.

## DE **FAMILIENTREFFEN**

Dieses Sortiment vereint sowohl Decken-, Wand- und Hängeleuchten als auch Tisch- und Stehleuchten. Verleihen Sie Ihren Räumlichkeiten eine einheitliche und stilvolle Rundumbeleuchtung.

## FR **RENCONTRE FAMILIALE**

Cette gamme réunit aussi bien des plafonniers, des éclairages muraux, des éclairages suspendus que des lampes de table et des lampadaires. Donnez à vos pièces un éclairage d'ensemble unifié et riche en style.















































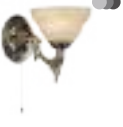













# OVERVIEW

LIGHTING FAMILIES / ESSENTIAL LUMINAIRES  
LEUCHTENFAMILIEN / STANDARD LEUCHTEN  
FAMILLES DE LUMINAIRES / LUMINAIRES ESSENTIEL

 TURALDO 232	 LIBERTAD 234, 236	 LIBERTAD 1 235	 CAMACHO 238-239	 BOYAL 240-243	 PANAGRIA 244-245	 CANTERRAS 246-247	 ABREOSA 248
 ALMUDAINA 250-251	 CASIBARE 252-253	 CREMELLA 254-255	 ROMAZZINA 256-259	 VENEZUELA 260-261	 ESCANDIDOS 262-263	 LURONE 264-265	 ESCANDELL 266-267
 NARICES 1 268	 NARICES 268-269	 BARBOTTO 270-273	 ERSEKA 274-275	 MANZANARES 276-277	 RONDO 278-280	 RONDO 3 280	 OPTICA 282-284
 GOROSIBA 1 286	 GOROSIBA 286-287	 PINTO TEXTIL 1 288	 PINTO TEXTIL 289	 PINTO NERO 290	 PINTO GOLD 292-293	 PINTO 294-295	 TROY 3 296-297
 RIVATO 298	 BAYMAN 299	 VINOVO 300	 MURCIA 300-301	 SAVOY 302-303	 MARBELLA 304-305	 ERVIDEL 306-307	 CLAVELLINA 308-309
 ISIDRO 310-311	 CARANACOA 312-313	 VALLEROSA 314-315	 CODRIALES 316-317	 GIANELLA 318-319	 SIBERIA 320-321	 LEJIAS 322-323	 LASANA 1 324, 329
 LASANA 2 324-325	 LASANA 3 326-327	 LASANA 328	 TARANDELL 329	 RONCADE 1 330	 SELVINA 1 330	 RONCADE 331, 334	 SELVINA 331-332, 335



This product is available in different colors and shapes. / Dieser Artikel ist in unterschiedlichen Farben und Formen verfügbar. / Cet article est disponible en différentes couleurs et formes.





VALMORA  
332-333



NEVADO  
333



PALOZZA 1  
334



PALOZZA  
335





DESIGN  
HIGHLIGHT  
DETAIL



**99077**



**99079**

**99077 TURALDO**

ceiling light; wood, brown  
Deckenleuchte; Holz, braun  
plafonnier; bois, marron

H 80, Ø 70



E27 1x 28W



9 002759 990770

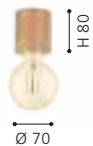

**99079 TURALDO**

table light; wood, brown  
Tischleuchte; Holz, braun  
luminaire de table; bois, marron

H 100, Ø 85



E27 1x 28W



9 002759 990794



**99078 TURALDO**

pendant light; wood, steel, brown, black  
Hängeleuchte; Holz, Stahl, braun, schwarz  
luminaire en suspension; bois, acier, marron, noir

H 1100, Ø 105



E27 1x 28W



9 002759 990787

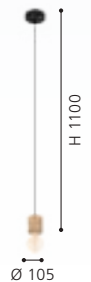



99078

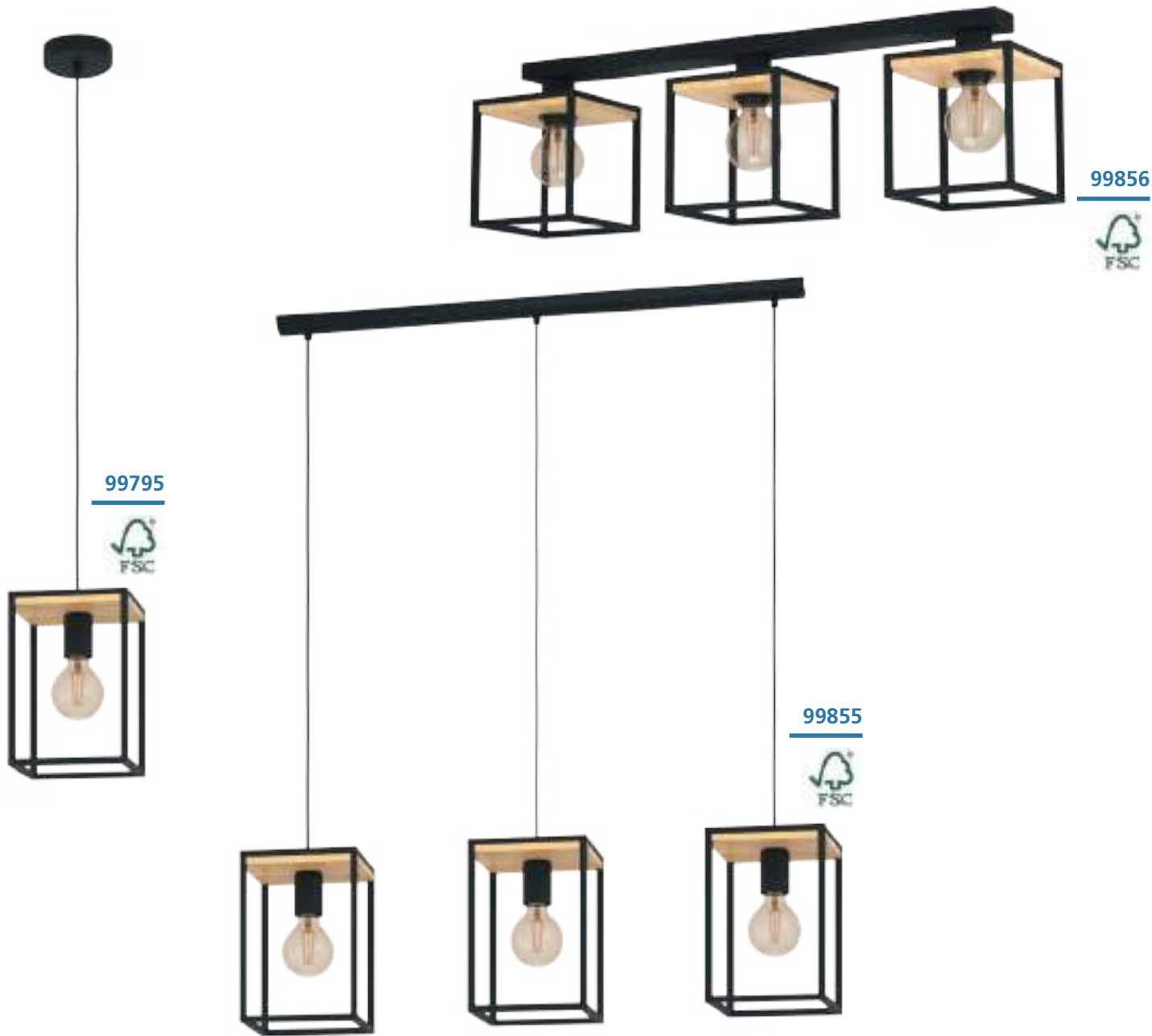

### 99795 LIBERTAD

pendant light; steel, wood, black, brown  
 Hängeleuchte; Stahl, Holz, schwarz, braun  
 luminaire en suspension; acier, bois, noir, marron

L 180, B 180, H 1100



E27 1x 40W



9 002759 997953

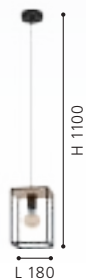

L 180

### 99855 LIBERTAD

pendant light; steel, wood, black, brown  
 Hängeleuchte; Stahl, Holz, schwarz, braun  
 luminaire en suspension; acier, bois, noir, marron

L 880, B 180, H 1100



E27 3x 40W



9 002759 998554



L 880

### 99856 LIBERTAD

ceiling light; steel, wood, black, brown  
 Deckenleuchte; Stahl, Holz, schwarz, braun  
 plafonnier; acier, bois, noir, marron

L 860, B 180, H 240



E27 3x 40W



9 002759 998561



L 860



900349



### 900349 LIBERTAD 1

pendant light; steel, wood, black, brown  
 Hängeleuchte; Stahl, Holz, schwarz, braun  
 luminaire en suspension; acier, bois, noir, marron

L 760, B 140, H 1100



E27



3x 40W



9 008606 243501

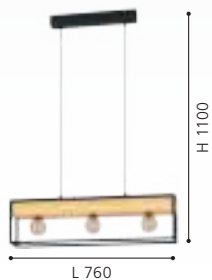

### 900349

The flower pots are included in these luminaires.

Bei diesen Leuchten sind die Blumentöpfe inkludiert.

Les pots de fleurs sont inclus dans ces luminaires.





99796



99798



### 99796 LIBERTAD

wall light; steel, wood, black, brown  
Wandleuchte; Stahl, Holz, schwarz, braun  
Applique; acier, bois, noir, marron

L 140, H 240, A 165



### 99798 LIBERTAD

floor light; steel, wood, black, brown  
Stehleuchte; Stahl, Holz, schwarz, braun  
lampadaire; acier, bois, noir, marron

L 180, B 180, H 1285

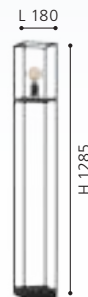
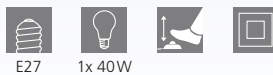

### 99797 LIBERTAD

table light; steel, wood, black, brown  
Tischleuchte; Stahl, Holz, schwarz, braun  
luminaire de table; acier, bois, noir, marron

L 140, B 140, H 350

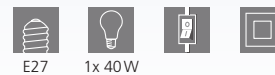



99797





### 99293 CAMACHO

pendant light; steel, wood, black, brown / plastic, white  
 Hängeleuchte; Stahl, Holz, schwarz, braun / Kunststoff, weiss  
 luminaire en suspension; acier, bois, noir, marron / plastique, blanc

L 1100, B 60, H 1100

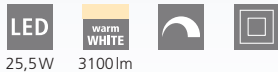

25,5W 3100lm



9 002759 992934

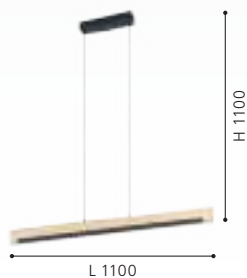

### 99292 CAMACHO

ceiling light; steel, wood, black, brown / plastic, white  
 Deckenleuchte; Stahl, Holz, schwarz, braun / Kunststoff, weiss  
 plafonnier; acier, bois, noir, marron / plastique, blanc

L 940, B 80, H 115



2x 10W 2600lm



9 002759 992927



### 99294 CAMACHO

wall light; steel, wood, black, brown / plastic, white  
 Wandleuchte; Stahl, Holz, schwarz, braun / Kunststoff, weiss  
 Applique; acier, bois, noir, marron / plastique, blanc

L 440, H 105, A 75



1x 9,6W 1050lm



9 002759 992941





TOUCH  
ME



99296



99295



99295, 99296

These luminaires can be switched on and off by touching the specially designed "Touch Me" part of the fixture.

Diese Leuchten können ein- und ausgeschaltet werden, indem man sie an den dafür vorgesehenen „Touch Me“ Bereichen berührt.

Ces luminaires peuvent être éteints et allumés simplement en touchant la partie spécialement conçue pour «Touch Me» du luminaire.

### 99296 CAMACHO

floor light; steel, wood, black, brown / plastic, white  
Stehleuchte; Stahl, Holz, schwarz, braun / Kunststoff, weiss  
lampadaire; acier, bois, noir, marron / plastique, blanc

L 75, B 20, H 1260, Base: B 250, T 200



19,5 W



2400lm

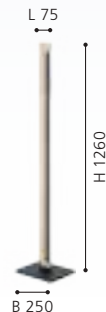

9 002759 992965

### 99295 CAMACHO

table light; steel, wood, black, brown / plastic, white  
Tischleuchte; Stahl, Holz, schwarz, braun / Kunststoff, weiss  
luminaire de table; acier, bois, noir, marron / plastique, blanc

L 75, B 20, H 405, Base: B 150, T 130



1x 6,5 W



800lm



9 002759 992958



### 99624 BOYAL

pendant light; steel, wood, black, brown rustic / plastic, white  
 Hängeleuchte; Stahl, Holz, schwarz, braun rustikal / Kunststoff, weiss  
 luminaire en suspension; acier, bois, noir, marron rustique / plastique, blanc

L 1010, B 400, H 1100

LED warm WHITE LED warm WHITE

2x 12,5W 3600lm 1x 15,5W 2250lm



9 002759 996246



### 99413 BOYAL

ceiling light; steel, wood, black, brown rustic / plastic, white  
 Deckenleuchte; Stahl, Holz, schwarz, braun rustikal / Kunststoff, weiss  
 plafonnier; acier, bois, noir, marron rustique / plastique, blanc

L 1010, B 400, H 95

LED warm WHITE LED warm WHITE

2x 12W 3400lm 1x 12W 1700lm



9 002759 994136

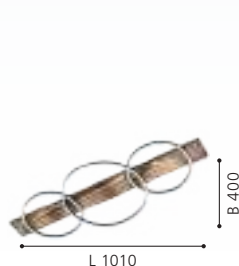

### 99408 BOYAL

ceiling light; steel, wood, black, brown rustic / plastic, white  
 Deckenleuchte; Stahl, Holz, schwarz, braun rustikal / Kunststoff, weiss  
 plafonnier; acier, bois, noir, marron rustique / plastique, blanc

L 780, B 400, H 90

LED warm WHITE LED warm WHITE

1x 12W 1700lm 1x 12W 1700lm



9 002759 994082





99353



99457



900892



### 99353 BOYAL

wall light; steel, wood, black, brown rustic / plastic, white  
Wandleuchte; Stahl, Holz, schwarz, braun rustikal / Kunststoff, weiss  
Applique; acier, bois, noir, marron rustique / plastique, blanc

L 300, H 560, A 75



1x 12W 1700lm



9 002759 993535



### 99457 BOYAL

table light; steel, wood, black, brown rustic / plastic, white  
Tischleuchte; Stahl, Holz, schwarz, braun rustikal / Kunststoff, weiss  
luminaire de table; acier, bois, noir, marron rustique / plastique, blanc

L 300, B 150, H 425, Base: B 110, T 150



1x 12W 1700lm



9 002759 994570



### 900892 BOYAL

floor light; steel, wood, black, brown rustic / plastic, white  
Stehleuchte; Stahl, Holz, schwarz, braun rustikal / Kunststoff, weiss  
lampadaire; acier, bois, noir, marron rustique / plastique, blanc

L 300, H 1500, Base: B 250, T 200



2x 12W 3400lm



9 008606 274574





### 99625 BOYAL

pendant light; steel, wood, black, brown / plastic, white  
 Hängeleuchte; Stahl, Holz, schwarz, braun / Kunststoff, weiss  
 luminaire en suspension; acier, bois, noir, marron / plastique, blanc

L 1010, B 400, H 1100

LED warm WHITE LED warm WHITE

2x 12,5W 3600lm 1x 15,5W 2250lm



9 002759 996253

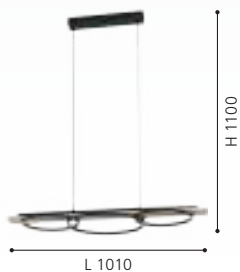

### 99468 BOYAL

ceiling light; steel, wood, black, brown / plastic, white  
 Deckenleuchte; Stahl, Holz, schwarz, braun / Kunststoff, weiss  
 plafonnier; acier, bois, noir, marron / plastique, blanc

L 1010, B 400, H 95

LED warm WHITE LED warm WHITE

2x 12W 3400lm 1x 12W 1700lm



9 002759 994686

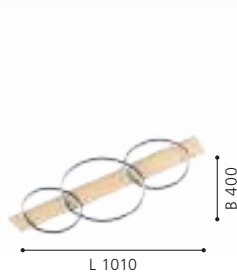

### 99467 BOYAL

ceiling light; steel, wood, black, brown / plastic, white  
 Deckenleuchte; Stahl, Holz, schwarz, braun / Kunststoff, weiss  
 plafonnier; acier, bois, noir, marron / plastique, blanc

L 780, B 400, H 90

LED warm WHITE LED warm WHITE

1x 12W 1700lm 1x 12W 1700lm



9 002759 994679





99469

LED



99466

LED

### 99469 BOYAL

table light; steel, wood, black, brown / plastic, white  
Tischleuchte; Stahl, Holz, schwarz, braun / Kunststoff, weiss  
luminaire de table; acier, bois, noir, marron / plastique, blanc

L 300, B 150, H 425, Base: B 110, T 150



1x 12W 1700lm



9 002759 994693



### 99466 BOYAL

wall light; steel, wood, black, brown / plastic, white  
Wandleuchte; Stahl, Holz, schwarz, braun / Kunststoff, weiss  
Applique; acier, bois, noir, marron / plastique, blanc

L 300, H 560, A 75



1x 12W 1700lm



9 002759 994662

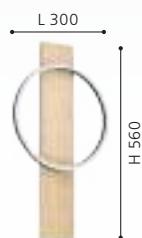



900489



900488



900491



### 900489 PANAGRIA

pendant light; aluminium, steel, wood, black, brown / plastic, white

Hängeleuchte; Alu, Stahl, Holz, schwarz, braun / Kunststoff, weiss

luminaire en suspension; aluminium, acier, bois, noir, marron / plastique, blanc

L 935, B 75, H 1100



2x 13W 3120lm



9 008606 244249

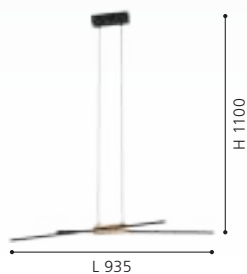

### 900488 PANAGRIA

ceiling light; aluminium, steel, wood, black, brown / plastic, white

Deckenleuchte; Alu, Stahl, Holz, schwarz, braun / Kunststoff, weiss

plafonnier; aluminium, acier, bois, noir, marron / plastique, blanc

L 935, B 75, H 110



2x 13W 3120lm



9 008606 244232



### 900491 PANAGRIA

wall light; aluminium, steel, wood, black, brown / plastic, white

Wandleuchte; Alu, Stahl, Holz, schwarz, braun / Kunststoff, weiss

Applique; aluminium, acier, bois, noir, marron / plastique, blanc

L 75, H 540, A 85



2x 6,3W 1510lm



9 008606 244256





900492



900493



DESIGN  
HIGHLIGHT  
DETAIL

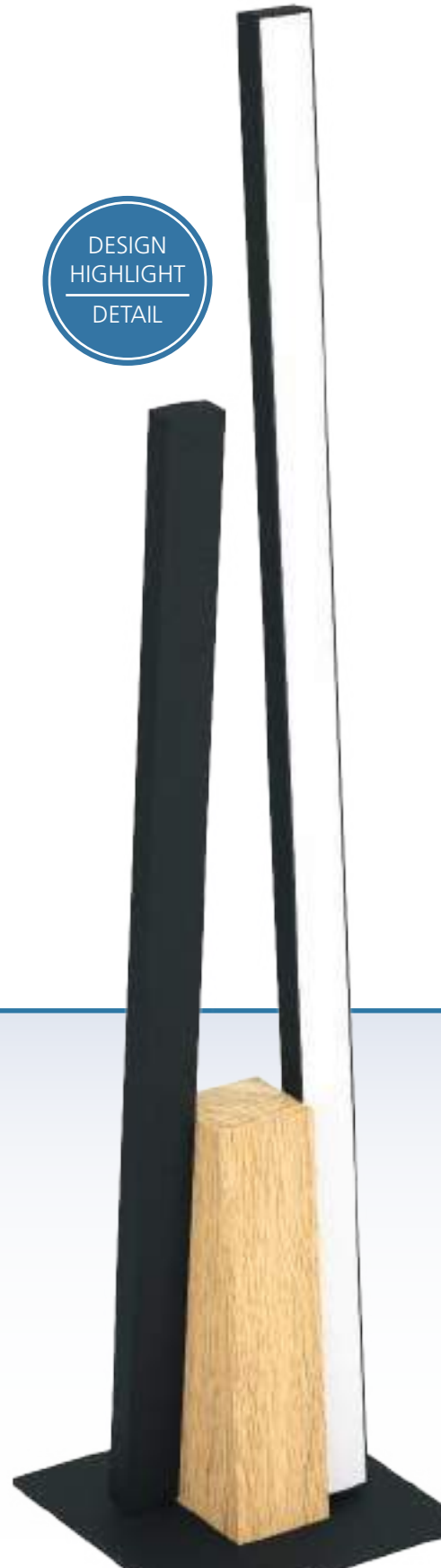

### 900492 PANAGRIA

table light; aluminium, steel, wood, black, brown / plastic, white  
Tischleuchte; Alu, Stahl, Holz, schwarz, braun / Kunststoff, weiss  
luminaire de table; aluminium, acier, bois, noir, marron /  
plastique, blanc

L 75, B 45, H 455, Base: B 100, T 100



1x 6,8W 1440lm 1x 5,2W



9 008606 244263



### 900493 PANAGRIA

floor light; aluminium, steel, wood, black, brown / plastic, white  
Stehleuchte; Alu, Stahl, Holz, schwarz, braun / Kunststoff, weiss  
lampadaire; aluminium, acier, bois, noir, marron / plastique,  
blanc

L 85, B 75, H 1460, Base: B 160, T 160



1x 12,8W 2880lm 1x 11,2W



9 008606 244270





99545



99544

### 99545 CANTERRAS

pendant light; steel, black / terrazzo, grey, white  
 Hängeleuchte; Stahl, schwarz / Terrazzo, grau, weiss  
 luminaire en suspension; acier, noir / terrazzo, gris, blanc

L 975, B 150, H 1100



### 99544 CANTERRAS

pendant light; steel, black / terrazzo, grey, white  
 Hängeleuchte; Stahl, schwarz / Terrazzo, grau, weiss  
 luminaire en suspension; acier, noir / terrazzo, gris, blanc

H 1100, Ø 150

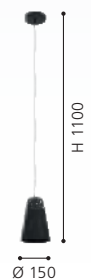





99546



99547



### 99546 CANTERRAS

wall light; steel, black / terrazzo, grey, white  
 Wandleuchte; Stahl, schwarz / Terrazzo, grau, weiss  
 Applique; acier, noir / terrazzo, gris, blanc

L 150, H 320, A 275



9 002759 995461



### 99547 CANTERRAS

floor light; steel, black / terrazzo, grey, white  
 Stehleuchte; Stahl, schwarz / Terrazzo, grau, weiss  
 lampadaire; acier, noir / terrazzo, gris, blanc

L 430, B 150, H 1785, Base: Ø 300

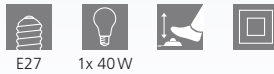

9 002759 995478





**99513**



**99512**

### 99513 ABREOSA

floor light; steel, black, grey  
Stehleuchte; Stahl, schwarz, grau  
lampadaire; acier, noir, gris

L 370, B 280, H 1510, Base: Ø 250

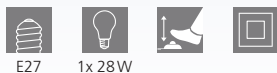

E27 1x 28W



9 002759 995133



### 99512 ABREOSA

pendant light; steel, black, grey  
Hängeleuchte; Stahl, schwarz, grau  
luminaire en suspension; acier, noir, gris

L 1080, B 280, H 1100



E27 3x 28W



9 002759 995126

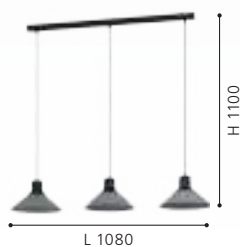

### 99511 ABREOSA

pendant light; steel, black, grey  
Hängeleuchte; Stahl, schwarz, grau  
luminaire en suspension; acier, noir, gris

H 1100, Ø 280



E27 1x 28W



9 002759 995119

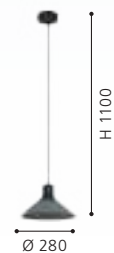



99511





900907



900907

This wall lamps have an on/off switch on the baldachin.

Diese Wandleuchten verfügen über einen ein/aus-Schalter am Baldachin.

Ces appliques disposent d'un interrupteur marche/arrêt sur le baldachin.



900909



900908



### 900907 ALMUDAINA

wall light; steel, black  
Wandleuchte; Stahl, schwarz  
Applique; acier, noir

L 110, H 200, A 200



1x 5W 480lm



9 008606 274116

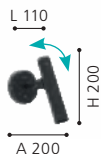

### 900909 ALMUDAINA

floor light; steel, black  
Stehleuchte; Stahl, schwarz  
lampadaire; acier, noir

H 1570, Base: Ø 270



1x 5W 480lm



9 008606 274130



### 900908 ALMUDAINA

table light; steel, black  
Tischleuchte; Stahl, schwarz  
luminaire de table; acier, noir

H 495, Base: Ø 170



1x 5W 480lm



9 008606 274123



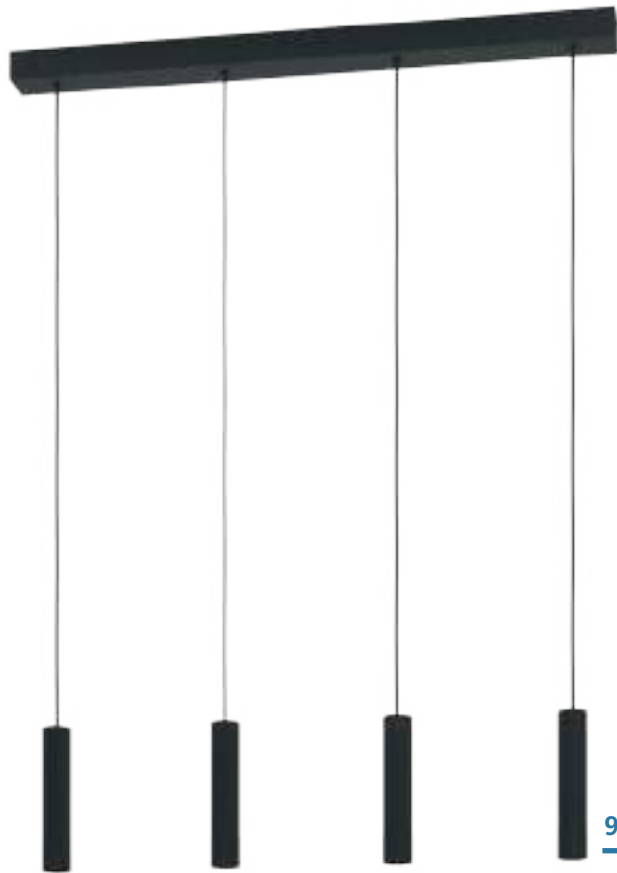

900906

LED



900926

LED

### 900906 ALMUDAINA

pendant light; steel, black  
Hängeleuchte; Stahl, schwarz  
luminaire en suspension; acier, noir

L 840, B 60, H 1100

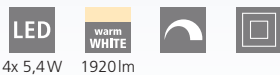

4x 5,4W 1920lm



9 008606 274109

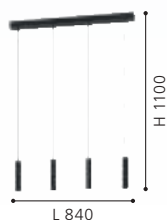

### 900926 ALMUDAINA

pendant light; steel, black  
Hängeleuchte; Stahl, schwarz  
luminaire en suspension; acier, noir

H 1100, Ø 40



1x 5W 480lm



9 008606 281817



### ALMUDAINA

The heads of the wall lamp, table lights and the floor lamp of the Almudaina series can be swiveled to the right and left as well as, down and up.

Die Köpfe der Wandleuchte, Tischleuchte und der Stehleuchte der Serie Almudaina lassen sich nach rechts und links sowie, nach unten und nach oben schwenken.

Les têtes de la lampe murale, les lumières de la table et la lampe à l'ordre de la série Almudaina peuvent être pivotés à droite et à gauche ainsi que, en bas et en haut.



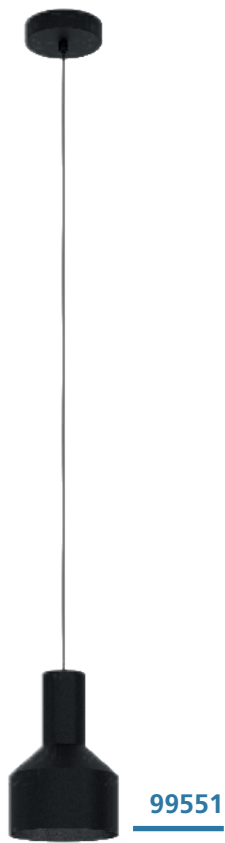

99551

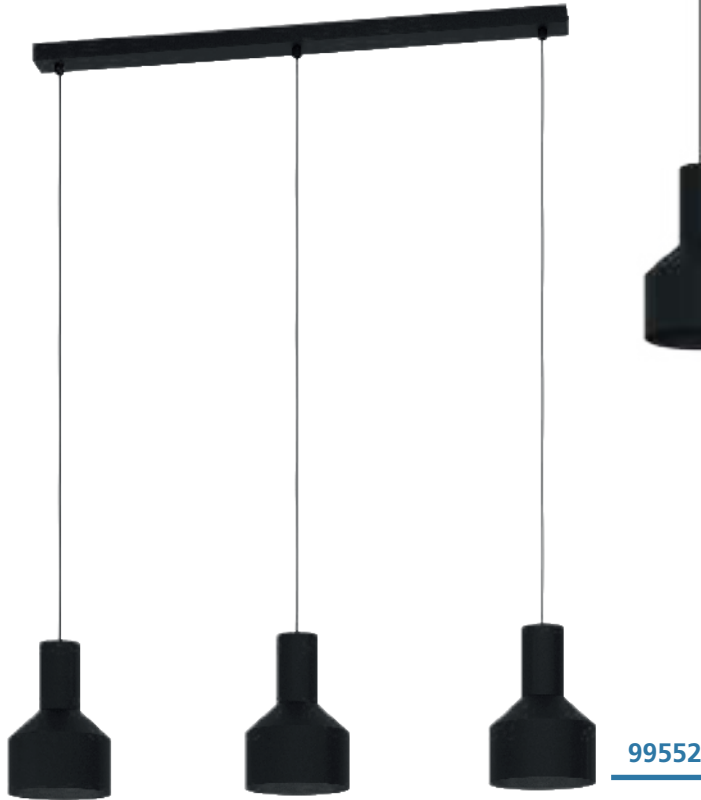

99552



99553

### 99551 CASIBARE

pendant light; steel, black  
Hängeleuchte; Stahl, schwarz  
luminaire en suspension; acier, noir

H 1100, Ø 150



E27 1x 40W



9 002759 995515



### 99552 CASIBARE

pendant light; steel, black  
Hängeleuchte; Stahl, schwarz  
luminaire en suspension; acier, noir

L 850, B 150, H 1100



E27 3x 40W



9 002759 995522

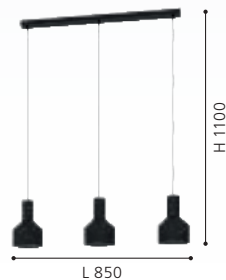

### 99553 CASIBARE

pendant light; steel, black  
Hängeleuchte; Stahl, schwarz  
luminaire en suspension; acier, noir

H 1500, Ø 710



E27 5x 40W



9 002759 995539





99554



99555

### 99554 CASIBARE

table light; steel, black  
Tischleuchte; Stahl, schwarz  
luminaire de table; acier, noir

L 160, B 120, H 490, Base: Ø 155



E27 1x 28W



9 002759 995546



### 99555 CASIBARE

floor light; steel, black  
Stehleuchte; Stahl, schwarz  
lampadaire; acier, noir

L 350, B 120, H 1605, Base: Ø 250



E27 2x 28W



9 002759 995553





**99345**



**900164**



**99346**

### 99345 CREMELLA

pendant light; steel, black  
Hängeleuchte; Stahl, schwarz  
luminaire en suspension; acier, noir

H 1100, Ø 370



### 900164 CREMELLA

ceiling light; steel, black  
Deckenleuchte; Stahl, schwarz  
plafonnier; acier, noir

H 260, Ø 370

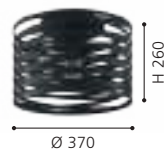

### 99346 CREMELLA

pendant light; steel, black  
Hängeleuchte; Stahl, schwarz  
luminaire en suspension; acier, noir

H 1100, Ø 180

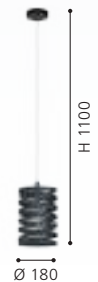





99347



99506



99507

### 99347 CREMELLA

pendant light; steel, black  
Hängeleuchte; Stahl, schwarz  
luminaire en suspension; acier, noir

L 940, B 180, H 1100



E27 3x 40W



9 002759 993474

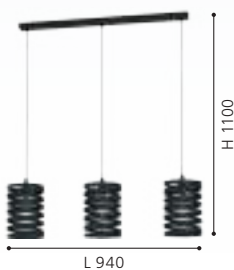

### 99506 CREMELLA

table light; steel, black  
Tischleuchte; Stahl, schwarz  
luminaire de table; acier, noir

H 290, Ø 180, Base: Ø 180



E27 1x 40W



9 002759 995065



### 99507 CREMELLA

floor light; steel, black  
Stehleuchte; Stahl, schwarz  
lampadaire; acier, noir

H 1510, Ø 370, Base: Ø 250



E27 1x 40W



9 002759 995072

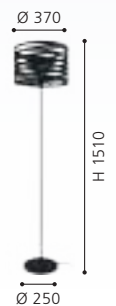



**900494**

**900495**

**900494 ROMAZZINA**

pendant light; steel, black  
 Hängeleuchte; Stahl, schwarz  
 luminaire en suspension; acier, noir

H 1100, Ø 325



**900495 ROMAZZINA**

pendant light; steel, black  
 Hängeleuchte; Stahl, schwarz  
 luminaire en suspension; acier, noir

L 900, B 200, H 1100

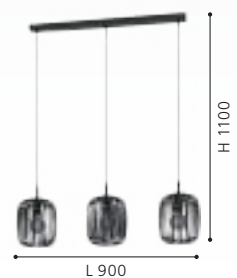



**900686**



900495 | 900519 | 900686



900494 | 900522



**900519**



**900522**

### 900686 ROMAZZINA

pendant light; steel, black  
Hängeleuchte; Stahl, schwarz  
luminaire en suspension; acier, noir

H 1100, Ø 460



### 900519 ROMAZZINA

table light; steel, black  
Tischleuchte; Stahl, schwarz  
luminaire de table; acier, noir

H 435, Ø 200, Base: Ø 225



### 900522 ROMAZZINA

floor light; steel, black  
Stehleuchte; Stahl, schwarz  
lampadaire; acier, noir

H 1405, Ø 325, Base: Ø 630

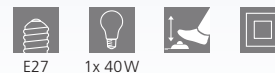



**900687**



**900496**



DESIGN  
HIGHLIGHT  
DETAIL

**900687 ROMAZZINA**

pendant light; steel, sandy  
Hängeleuchte; Stahl, sandfarben  
luminaire en suspension; acier, couleur sable

H 1100, Ø 460



E27 3x 40W



9 008606 258574



**900496 ROMAZZINA**

pendant light; steel, sandy  
Hängeleuchte; Stahl, sandfarben  
luminaire en suspension; acier, couleur sable

H 1100, Ø 325



E27 1x 40W



9 008606 244300





900497 | 900521 | 900687



900496 | 900523



### 900497 ROMAZZINA

pendant light; steel, sandy  
Hängeleuchte; Stahl, sandfarben  
luminaire en suspension; acier, couleur sable

L 900, B 200, H 1100



### 900521 ROMAZZINA

table light; steel, sandy  
Tischleuchte; Stahl, sandfarben  
luminaire de table; acier, couleur sable

H 435, Ø 200, Base: Ø 225

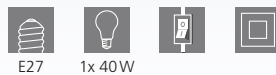

### 900523 ROMAZZINA

floor light; steel, sandy  
Stehleuchte; Stahl, sandfarben  
lampadaire; acier, couleur sable

H 1405, Ø 325, Base: Ø 630

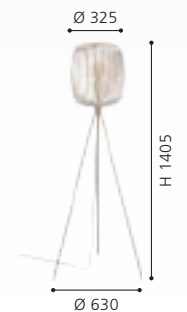
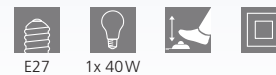



### 900165 VENEZUELA

ceiling light; steel, black, gold  
 Deckenleuchte; Stahl, schwarz, gold  
 plafonnier; acier, noir, or

H 250, Ø 385



### 900166 VENEZUELA

pendant light; steel, black, gold  
 Hängeleuchte; Stahl, schwarz, gold  
 luminaire en suspension; acier, noir, or

H 1100, Ø 235

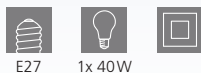

### 900167 VENEZUELA

pendant light; steel, black, gold  
 Hängeleuchte; Stahl, schwarz, gold  
 luminaire en suspension; acier, noir, or

L 935, B 235, H 1100





**900168**

**900168 VENEZUELA**

table light; steel, black, gold  
Tischleuchte; Stahl, schwarz, gold  
luminaire de table; acier, noir, or

H 225, Ø 235, Base: Ø 115



E27



1x 40W



9 008606 242801





**99806**



**99807**



**99809**

### 99806 ESCANDIDOS

pendant light; steel, black, brass / steel, black, gold  
 Hängeleuchte; Stahl, schwarz, messing / Stahl, schwarz, gold  
 luminaire en suspension; acier, noir, laiton / acier, noir, or

H 1100, Ø 220



E27 1x 40W



9 002759 998066

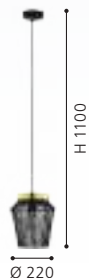

### 99807 ESCANDIDOS

pendant light; steel, black, brass / steel, black, gold  
 Hängeleuchte; Stahl, schwarz, messing / Stahl, schwarz, gold  
 luminaire en suspension; acier, noir, laiton / acier, noir, or

L 920, B 220, H 1100



E27 3x 40W



9 002759 998073



### 99809 ESCANDIDOS

floor light; steel, black, brass / steel, black, gold  
 Stehleuchte; Stahl, schwarz, messing / Stahl, schwarz, gold  
 lampadaire; acier, noir, laiton / acier, noir, or

L 310, B 220, H 1700, Base: B 300, T 200

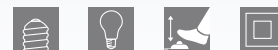

E27 1x 40W



9 002759 998097







99808

### 99808 ESCANDIDOS

table light; steel, black, brass / steel, black, gold  
Tischleuchte; Stahl, schwarz, messing / Stahl, schwarz, gold  
luminaire de table; acier, noir, laiton / acier, noir, or

H 260, Ø 220, Base: Ø 150



DESIGN  
HIGHLIGHT  
DETAIL



**900177**



### 900177 LURONE

pendant light; steel, black, brass  
Hängeleuchte; Stahl, schwarz, messing  
luminaire en suspension; acier, noir, laiton

L 1000, B 50, H 1100



E27



4x 10W



9 008606 241132

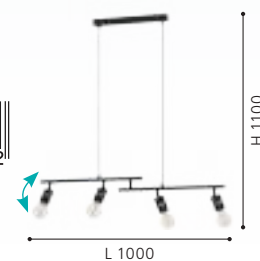



900176



900178



900179

### 900176 LURONE

ceiling light; steel, black, brass  
Deckenleuchte; Stahl, schwarz, messing  
plafonnier; acier, noir, laiton

L 1000, B 50, H 270



### 900178 LURONE

table light; steel, black, brass  
Tischleuchte; Stahl, schwarz, messing  
luminaire de table; acier, noir, laiton

L 205, B 50, H 500, Base: Ø 200



### 900179 LURONE

floor light; steel, black, brass  
Stehleuchte; Stahl, schwarz, messing  
lampadaire; acier, noir, laiton

L 205, B 50, H 1600, Base: Ø 250

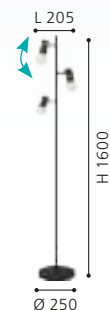



**900731**



**900732**

### 900731 ESCANDELL

pendant light; steel, black, brushed brass  
 Hängeleuchte; Stahl, schwarz, messing-gebürstet  
 luminaire en suspension; acier, noir, laiton brossé

H 1100, Ø 250



### 900732 ESCANDELL

pendant light; steel, black, brushed brass  
 Hängeleuchte; Stahl, schwarz, messing-gebürstet  
 luminaire en suspension; acier, noir, laiton brossé

L 950, B 250, H 1100

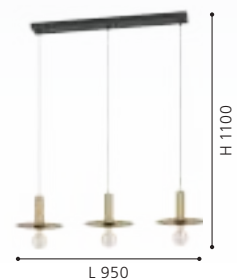

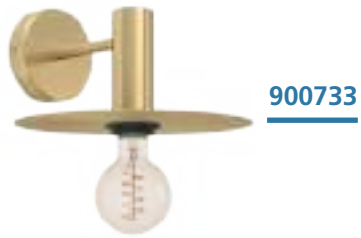

**900733**



EGLO  
RECOMMENDS  
**110079**  
ESCANDELL



**900734**



**900735**

### 900733 ESCANDELL

wall light; steel, brushed brass  
Wandleuchte; Stahl, messing-gebürstet  
Applique; acier, laiton brossé

L 250, H 120, A 270



E27 1x 40W



9 008606 273898

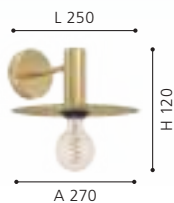

### 900734 ESCANDELL

table light; steel, brushed brass  
Tischleuchte; Stahl, messing-gebürstet  
luminaire de table; acier, laiton brossé

L 220, B 230, H 470, Base: Ø 220

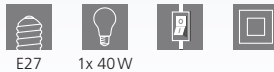

E27 1x 40W



9 008606 273904

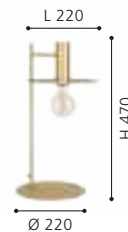

### 900735 ESCANDELL

floor light; steel, brushed brass  
Stehleuchte; Stahl, messing-gebürstet  
lampadaire; acier, laiton brossé

L 270, B 250, H 1560, Base: Ø 270



E27 1x 40W



9 008606 273911





**900843**



**900843**

These luminaires can be mounted wider or narrower according to the customer's requirements due to the mounting knobs.

Diese Leuchten können aufgrund der Befestigungsknöpfe je nach Kundenwunsch weiter oder enger montiert werden.

Grâce aux boutons de fixation, ces luminaires peuvent être montés plus ou moins loin, selon les souhaits du client.



**99593**



DESIGN  
HIGHLIGHT  
DETAIL

**900843 NARICES 1**

pendant light; steel, black / steel, brushed brass, gold  
Hängeleuchte; Stahl, schwarz / Stahl, messing-gebürstet, gold  
luminaire en suspension; acier, noir / acier, laiton brossé, or

L 1730, B 260, H 1100

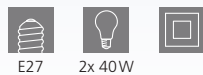

E27 2x 40W



9 008606 270286



**99593 NARICES**

table light; steel, black / steel, brushed brass, gold  
Tischleuchte; Stahl, schwarz / Stahl, messing-gebürstet, gold  
luminaire de table; acier, noir / acier, laiton brossé, or

L 295, B 220, H 500, Base: Ø 220



E27 1x 40W



9 002759 995935

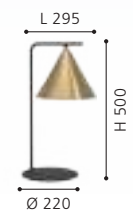



### 99592 NARICES

pendant light; steel, black / steel, brushed brass, gold  
 Hängeleuchte; Stahl, schwarz / Stahl, messing-gebürstet, gold  
 luminaire en suspension; acier, noir / acier, laiton brossé, or

L 920, B 220, H 1100

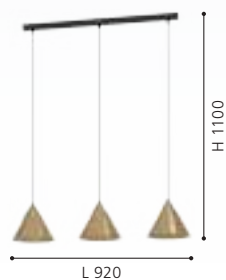

### 99591 NARICES

pendant light; steel, black / steel, brushed brass, gold  
 Hängeleuchte; Stahl, schwarz / Stahl, messing-gebürstet, gold  
 luminaire en suspension; acier, noir / acier, laiton brossé, or

H 1100, Ø 220

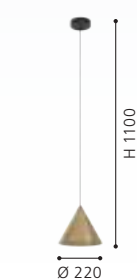

### 99594 NARICES

floor light; steel, black / steel, brushed brass, gold  
 Stehleuchte; Stahl, schwarz / Stahl, messing-gebürstet, gold  
 lampadaire; acier, noir / acier, laiton brossé, or

L 295, B 220, H 1620, Base: Ø 270





900873

LED



900872

LED

### 900873 BARBOTTO

pendant light; steel, black, gold  
 Hängeleuchte; Stahl, schwarz, gold  
 luminaire en suspension; acier, noir, or

L 925, B 60, H 1100

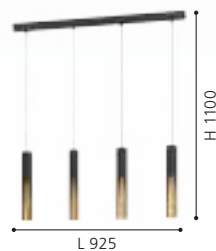
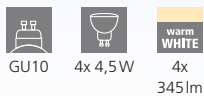

### 900872 BARBOTTO

pendant light; steel, black, gold  
 Hängeleuchte; Stahl, schwarz, gold  
 luminaire en suspension; acier, noir, or

H 1100, Ø 60

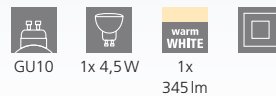





97583

LED

97584

LED

### 97583 BARBOTTO

table light; steel, black, gold  
Tischleuchte; Stahl, schwarz, gold  
luminaire de table; acier, noir, or

H 395, Ø 60, Base: Ø 100

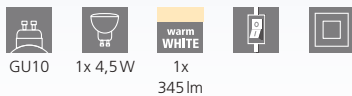

GU10 1x 4,5W 1x 345lm

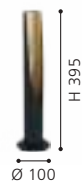

### 97584 BARBOTTO

floor light; steel, black, gold  
Stehleuchte; Stahl, schwarz, gold  
lampadaire; acier, noir, or

H 1370, Ø 60, Base: Ø 185

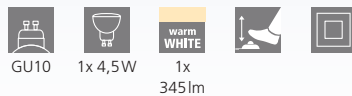

GU10 1x 4,5W 1x 345lm





900875



900876



**900875 BARBOTTO**

pendant light; steel, wood, black, brown  
 Hängeleuchte; Stahl, Holz, schwarz, braun  
 luminaire en suspension; acier, bois, noir, marron

L 925, B 60, H 1100

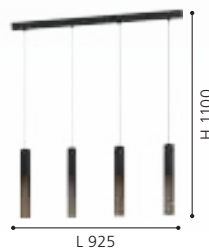
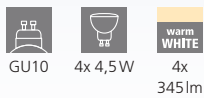

**900876 BARBOTTO**

table light; steel, wood, black, brown  
 Tischleuchte; Stahl, Holz, schwarz, braun  
 luminaire de table; acier, bois, noir, marron

H 395, Ø 60, Base: Ø 100

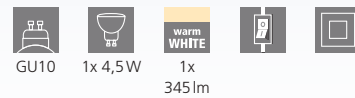



900877

LED



900874

LED

### 900877 BARBOTTO

floor light; steel, wood, black, brown  
Stehleuchte; Stahl, Holz, schwarz, braun  
lampadaire; acier, bois, noir, marron

H 1365, Ø 60, Base: Ø 185



GU10



1x 4,5W



1x

345lm



9 008606 270347



### 900874 BARBOTTO

pendant light; steel, wood, black, brown  
Hängeleuchte; Stahl, Holz, schwarz, braun  
luminaire en suspension; acier, bois, noir, marron

H 1100, Ø 60



GU10



1x 4,5W



1x

345lm



9 008606 270316





**99098**



**99096**



**99097**

### 99098 ERSEKA

pendant light; steel, brass / brilliant glass, clear  
 Hängeleuchte; Stahl, messing / Brillantglas, klar  
 luminaire en suspension; acier, laiton / verre brillant, transparent

H 1300, Ø 385



### 99097 ERSEKA

pendant light; steel, brass / brilliant glass, clear  
 Hängeleuchte; Stahl, messing / Brillantglas, klar  
 luminaire en suspension; acier, laiton / verre brillant, transparent

H 1450, Ø 485



### 99096 ERSEKA

ceiling light; steel, brass / brilliant glass, clear  
 Deckenleuchte; Stahl, messing / Brillantglas, klar  
 plafonnier; acier, laiton / verre brillant, transparent

H 535, Ø 485

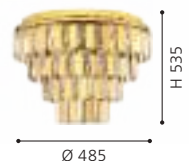
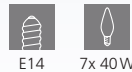



**99095**



**99093**



**99094**



EGLO  
RECOMMENDS  
**110025**

ERSEKA

### 99095 ERSEKA

pendant light; steel, chrome / brilliant glass, clear  
Hängeleuchte; Stahl, chrom / Brillantglas, klar  
luminaire en suspension; acier, chrome / verre brillant, transparent

H 1300, Ø 385



E14 5x 40W



9 002759 990954



### 99094 ERSEKA

pendant light; steel, chrome / brilliant glass, clear  
Hängeleuchte; Stahl, chrom / Brillantglas, klar  
luminaire en suspension; acier, chrome / verre brillant, transparent

H 1450, Ø 485



E14 7x 40W



9 002759 990947



### 99093 ERSEKA

ceiling light; steel, chrome / brilliant glass, clear  
Deckenleuchte; Stahl, chrom / Brillantglas, klar  
plafonnier; acier, chrome / verre brillant, transparent

H 535, Ø 485



E14 7x 40W



9 002759 990930





**900305**



MANZANARES

### 900305 MANZANARES

pendant light; steel, brushed brass, gold / matte-opal glass, white

Hängeleuchte; Stahl, messing-gebürstet, gold / Glas opal-matt, weiss

luminaire en suspension; acier, laiton brossé, or / verre opale mat, blanc

H 1100, Ø 225



E27



1x 40W



9 008606 235902

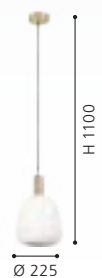



**900306**



**900304**



**900307**

### 900306 MANZANARES

pendant light; steel, brushed brass, gold / matte-opal glass, white

Hängeleuchte; Stahl, messing-gebürstet, gold / Glas opal-matt, weiss

luminaire en suspension; acier, laiton brossé, or / verre opale mat, blanc

L 970, B 145, H 1100



E27 4x 40W



9 008606 235919

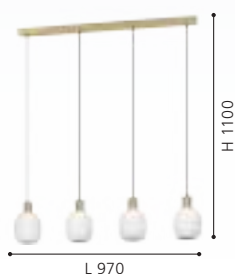

L 970

H 1100

### 900304 MANZANARES

ceiling light; steel, brushed brass, gold / matte-opal glass, white  
Deckenleuchte; Stahl, messing-gebürstet, gold / Glas opal-matt, weiss

plafonnier; acier, laiton brossé, or / verre opale mat, blanc

H 190, Ø 450



E27 3x 40W



9 008606 235896

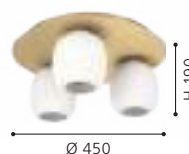

Ø 450

H 190

### 900307 MANZANARES

table light; steel, brushed brass, gold / matte-opal glass, white  
Tischleuchte; Stahl, messing-gebürstet, gold / Glas opal-matt, weiss

luminaire de table; acier, laiton brossé, or / verre opale mat, blanc

H 180, Ø 145, Base: Ø 90

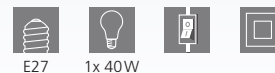

E27 1x 40W



9 008606 235926



Ø 90

H 180



**85261**



**85262**

### 85261 RONDO

pendant light; steel, satin nickel / matte-opal glass, white  
 Hängeleuchte; Stahl, nickel-matt / Glas opal-matt, weiss  
 luminaire en suspension; acier, nickel mat / verre opale mat, blanc

H 1100, Ø 200



### 85262 RONDO

pendant light; steel, satin nickel / matte-opal glass, white  
 Hängeleuchte; Stahl, nickel-matt / Glas opal-matt, weiss  
 luminaire en suspension; acier, nickel mat / verre opale mat, blanc

H 1100, Ø 250

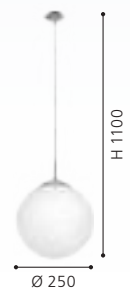





**85263**



**91589**



**85264**



### 85263 RONDO

pendant light; steel, satin nickel / matte-opal glass, white  
Hängeleuchte; Stahl, nickel-matt / Glas opal-matt, weiss  
luminaire en suspension; acier, nickel mat / verre opale mat, blanc

H 1100, Ø 300



### 91589 RONDO

ceiling light; steel, satin nickel / matte-opal glass, white  
Deckenleuchte; Stahl, nickel-matt / Glas opal-matt, weiss  
plafonnier; acier, nickel mat / verre opale mat, blanc

H 315, Ø 250

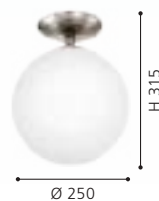

### 85264 RONDO

table light; plastic, white / matte-opal glass, white  
Tischleuchte; Kunststoff, weiss / Glas opal-matt, weiss  
luminaire de table; plastique, blanc / verre opale mat, blanc

H 200, Ø 200

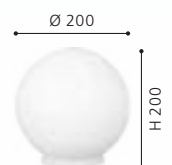
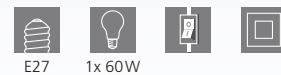



**900395**

**900512**

The flower pots are included in these luminaires.

Bei diesen Leuchten sind die Blumentöpfe inkludiert.

Les pots de fleurs sont inclus dans ces luminaires.

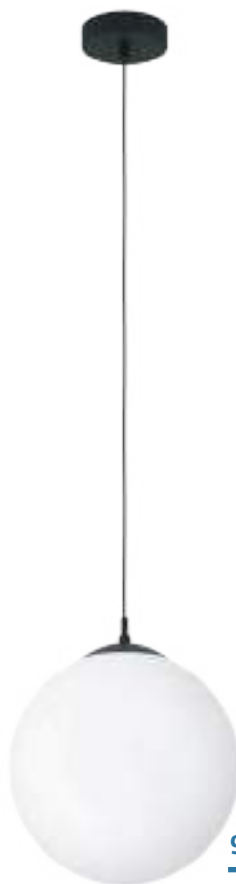

**900511**



**900395 RONDO**

pendant light; steel, satin nickel / matte-opal glass, white  
 Hängeleuchte; Stahl, nickel-matt / Glas opal-matt, weiss  
 luminaire en suspension; acier, nickel mat / verre opale mat, blanc

L 960, B 200, H 1100



E27

3x 40W

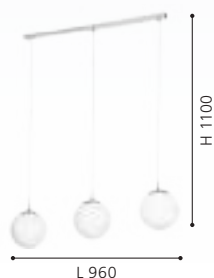

9 008606 239467

**900511 RONDO 3**

pendant light; steel, black / matte-opal glass, white  
 Hängeleuchte; Stahl, schwarz / Glas opal-matt, weiss  
 luminaire en suspension; acier, noir / verre opale mat, blanc

H 1100, Ø 300



E27

1x 40W



9 008606 244409

**900512 RONDO 3**

pendant light; steel, black / matte-opal glass, white  
 Hängeleuchte; Stahl, schwarz / Glas opal-matt, weiss  
 luminaire en suspension; acier, noir / verre opale mat, blanc

L 1210, B 200, H 1100



E27

3x 40W

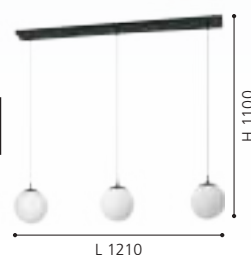

9 008606 244416



900512



86817



### 86817 OPTICA

floor light; steel, satin nickel / matte-opal glass, white  
Stehleuchte; Stahl, nickel-matt / Glas opal-matt, weiss  
lampadaire; acier, nickel mat / verre opale mat, blanc

H 1570, Ø 350



E27



2x 60W



Ø 350

H 1570





**86811**



**86812**

### 86811 OPTICA

wall/ceiling light; steel, satin nickel / matte-opal glass, white  
Wand- / Deckenleuchte; Stahl, nickel-matt / Glas opal-matt, weiss  
Applique/Plafonnier; acier, nickel mat / verre opale mat, blanc

H 160, Ø 280



E27 2x 60W

### 86812 OPTICA

wall/ceiling light; steel, satin nickel / matte-opal glass, white  
Wand- / Deckenleuchte; Stahl, nickel-matt / Glas opal-matt, weiss  
Applique/Plafonnier; acier, nickel mat / verre opale mat, blanc

H 210, Ø 350

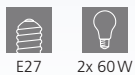

E27 2x 60W



9 002759 868116

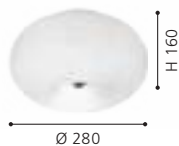

9 002759 868123

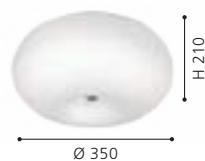

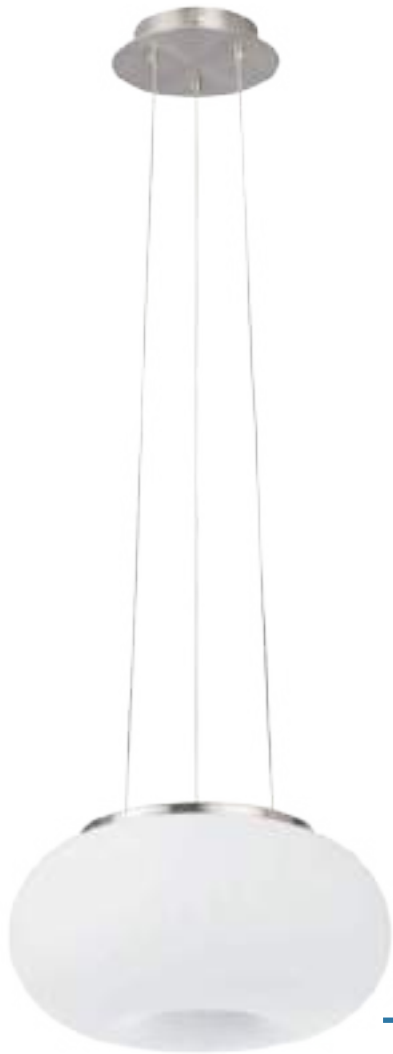

**86813**



**86814**



OPTICA

**86813 OPTICA**

pendant light; steel, satin nickel / matte-opal glass, white  
Hängeleuchte; Stahl, nickel-matt / Glas opal-matt, weiss  
luminaire en suspension; acier, nickel mat / verre opale mat, blanc

H 1100, Ø 280



**86814 OPTICA**

pendant light; steel, satin nickel / matte-opal glass, white  
Hängeleuchte; Stahl, nickel-matt / Glas opal-matt, weiss  
luminaire en suspension; acier, nickel mat / verre opale mat, blanc

H 1100, Ø 350



**86815 OPTICA**

pendant light; steel, satin nickel / matte-opal glass, white  
Hängeleuchte; Stahl, nickel-matt / Glas opal-matt, weiss  
luminaire en suspension; acier, nickel mat / verre opale mat, blanc

H 1100, Ø 445

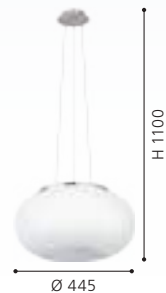



86815



99631



99632



DESIGN  
HIGHLIGHT  
DETAIL



33984

### 99631 GOROSIBA 1

ceiling light; steel, black / glass vaporized, black-transparent  
Deckenleuchte; Stahl, schwarz / Glas bedampft, schwarz-transparent  
plafonnier; acier, noir / verre vaporisé, noir transparent

H 175, Ø 450



E27 3x 40W

### 99632 GOROSIBA 1

ceiling light; steel, black / glass vaporized, black-transparent  
Deckenleuchte; Stahl, schwarz / Glas bedampft, schwarz-transparent  
plafonnier; acier, noir / verre vaporisé, noir transparent

L 380, B 380, H 170



E27 4x 40W

### 33984 GOROSIBA

table light; steel, black / glass vaporized, black-transparent  
Tischleuchte; Stahl, schwarz / Glas bedampft, schwarz-transparent  
luminaire de table; acier, noir / verre vaporisé, noir transparent

H 220, Ø 150, Base: Ø 100



E27 1x 60W



9 002759 996314



9 002759 996321



9 002759 339845







98752



98752



98753



98753 | 98754



98754

### 98752 GOROSIBA

pendant light; steel, black / glass vaporized, black-transparent  
Hängeleuchte; Stahl, schwarz / Glas bedampft, schwarz-transparent

luminaire en suspension; acier, noir / verre vaporisé, noir transparent

H 1100, Ø 150

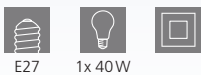

E27 1x 40W



9 002759 987527



### 98753 GOROSIBA

pendant light; steel, black / glass vaporized, black-transparent  
Hängeleuchte; Stahl, schwarz / Glas bedampft, schwarz-transparent

luminaire en suspension; acier, noir / verre vaporisé, noir transparent

L 850, B 150, H 1100



E27 3x 40W



9 002759 987534



### 98754 GOROSIBA

pendant light; steel, black / glass vaporized, black-transparent  
Hängeleuchte; Stahl, schwarz / Glas bedampft, schwarz-transparent

luminaire en suspension; acier, noir / verre vaporisé, noir transparent

H 1300, Ø 410



E27 3x 40W



9 002759 987541





**900341**



**900342**



### 900341 PINTO TEXTIL 1

pendant light; steel, black / glass, fabric, clear, black  
 Hängeleuchte; Stahl, schwarz / Glas, Textil, klar, schwarz  
 luminaire en suspension; acier, noir / verre, tissu, transparent, noir

H 1100, Ø 120



E27 1x 10W



9 008606 235681



### 900342 PINTO TEXTIL 1

pendant light; steel, black / glass, fabric, clear, black  
 Hängeleuchte; Stahl, schwarz / Glas, Textil, klar, schwarz  
 luminaire en suspension; acier, noir / verre, tissu, transparent, noir

L 820, B 120, H 1100



E27 3x 10W



9 008606 235698

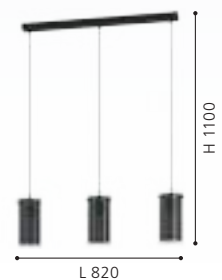



**99286**



**99287**



99286 | 99287



99288



**99288**

### 99286 PINTO TEXTIL

pendant light; steel, satin nickel / glass, fabric, clear, grey  
Hängeleuchte; Stahl, nickel-matt / Glas, Textil, klar, grau  
luminaire en suspension; acier, nickel mat / verre, tissu, transparent, gris

L 820, B 120, H 1100



E27 3x 16W



9 002759 992866

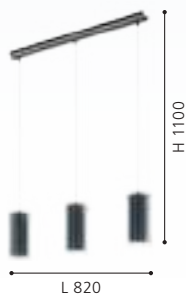

### 99287 PINTO TEXTIL

pendant light; steel, satin nickel / glass, fabric, clear, grey  
Hängeleuchte; Stahl, nickel-matt / Glas, Textil, klar, grau  
luminaire en suspension; acier, nickel mat / verre, tissu, transparent, gris

L 945, B 120, H 1100



E27 4x 16W



9 002759 992873



### 99288 PINTO TEXTIL

wall light; steel, satin nickel / glass, fabric, clear, grey  
Wandleuchte; Stahl, nickel-matt / Glas, Textil, klar, grau  
Applique; acier, nickel mat / verre, tissu, transparent, gris

L 120, H 445, A 180



E27 1x 16W



9 002759 992880





90304



PINTO NERO

### 90304 PINTO NERO

pendant light; steel, satin nickel / smoked glass, matte-opal glass, black-transparent, white

Hängeleuchte; Stahl, nickel-matt / Rauchglas, Glas opal-matt, schwarz-transparent, weiss

luminaire en suspension; acier, nickel mat / verre fumé, verre opale mat, noir transparent, blanc

H 1100, Ø 110



E27



1x 40W



9 002759 903046



### 90305 PINTO NERO

pendant light; steel, satin nickel / smoked glass, matte-opal glass, black-transparent, white

Hängeleuchte; Stahl, nickel-matt / Rauchglas, Glas opal-matt, schwarz-transparent, weiss

luminaire en suspension; acier, nickel mat / verre fumé, verre opale mat, noir transparent, blanc

L 725, H 1100



E27



3x 40W



9 002759 903053

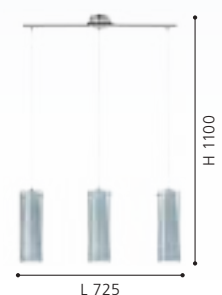



90305



**97653**



**97651**



**97839**

### 97653 PINTO GOLD

pendant light; steel, black / glass, clear, gold  
 Hängeleuchte; Stahl, schwarz / Glas, klar, gold  
 luminaire en suspension; acier, noir / verre, transparent, or

L 905, B 360, H 1100



E27



4x 40W



9 002759 976538

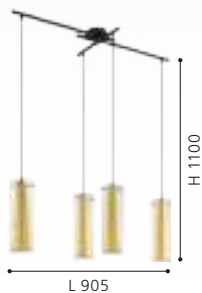

### 97651 PINTO GOLD

pendant light; steel, black / glass, clear, gold  
 Hängeleuchte; Stahl, schwarz / Glas, klar, gold  
 luminaire en suspension; acier, noir / verre, transparent, or

H 1100, Ø 110



E27



1x 40W



9 002759 976514



### 97839 PINTO GOLD

wall light; steel, black / glass, clear, gold  
 Wandleuchte; Stahl, schwarz / Glas, klar, gold  
 Applique; acier, noir / verre, transparent, or

L 110, H 270, A 150



E27



1x 40W



9 002759 978396





**97652**



**97655**



PINTO GOLD



**97652 PINTO GOLD**

pendant light; steel, black / glass, clear, gold  
 Hängeleuchte; Stahl, schwarz / Glas, klar, gold  
 luminaire en suspension; acier, noir / verre, transparent, or

L 725, B 110, H 1100



9 002759 976521

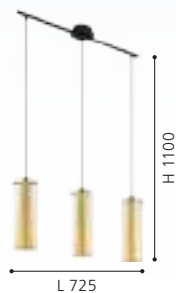

**97655 PINTO GOLD**

floor light; steel, black, gold / glass, clear, gold  
 Stehleuchte; Stahl, schwarz, gold / Glas, klar, gold  
 lampadaire; acier, noir, or / verre, transparent, or

H 1470, Ø 110, Base: Ø 230



9 002759 976552



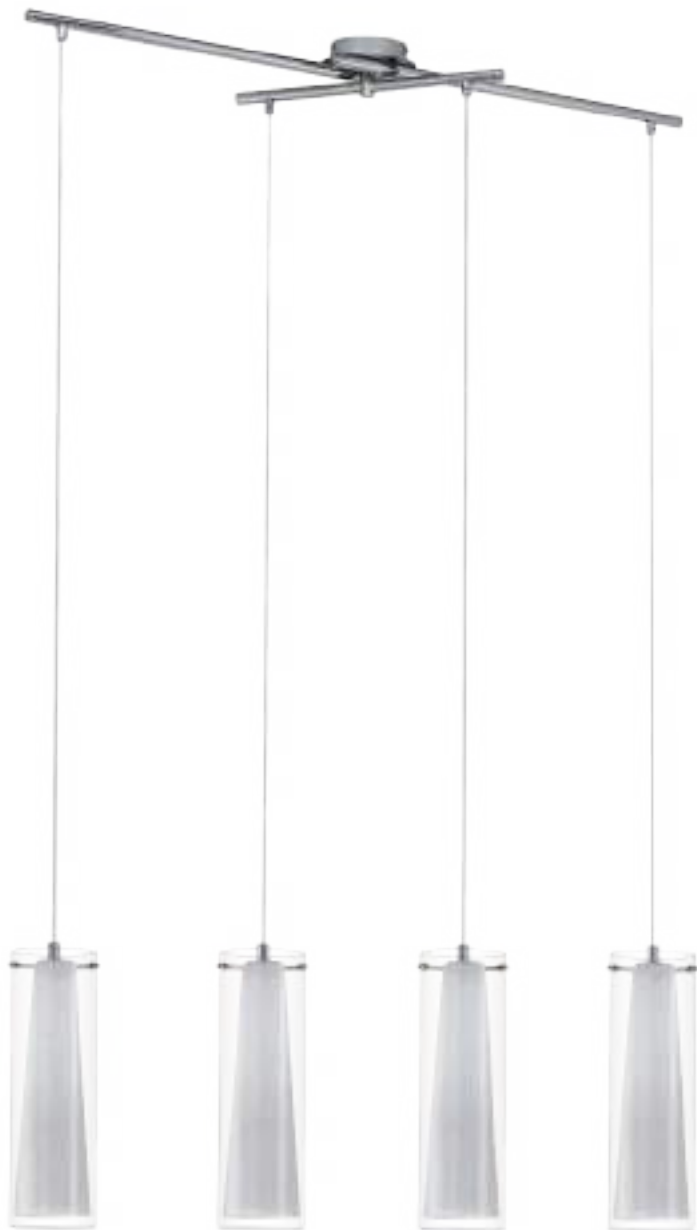

**89834**



89832 | 89833 | 89834 |  
89835 | 89836



**89832**



**89835**

### 89834 PINTO

pendant light; steel, chrome / glass, matte-opal glass, clear, white  
Hängeleuchte; Stahl, chrom / Glas, Glas opal-matt, klar, weiss  
luminaire en suspension; acier, chrome / verre, verre opale mat, transparent, blanc

L 905, B 360, H 1100



E27 4x 40W

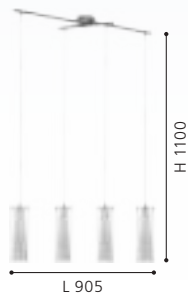

9 002759 898342

### 89835 PINTO

table light; steel, chrome / glass, matte-opal glass, clear, white  
Tischleuchte; Stahl, chrom / Glas, Glas opal-matt, klar, weiss  
luminaire de table; acier, chrome / verre, verre opale mat, transparent, blanc

H 500, Ø 110, Base: Ø 155



E27 1x 40W



9 002759 898359

### 89832 PINTO

pendant light; steel, chrome / glass, matte-opal glass, clear, white  
Hängeleuchte; Stahl, chrom / Glas, Glas opal-matt, klar, weiss  
luminaire en suspension; acier, chrome / verre, verre opale mat, transparent, blanc

H 1100, Ø 110



E27 1x 40W



9 002759 898328





**93003**



**89833**



**89836**

### 93003 PINTO

pendant light; steel, chrome / glass, matte-opal glass, clear, white

Hängeleuchte; Stahl, chrom / Glas, Glas opal-matt, klar, weiss  
luminaire en suspension; acier, chrome / verre, verre opale mat, transparent, blanc

H 1500, Ø 500



E27 5x 40W



9 002759 930035



### 89833 PINTO

pendant light; steel, chrome / glass, matte-opal glass, clear, white

Hängeleuchte; Stahl, chrom / Glas, Glas opal-matt, klar, weiss  
luminaire en suspension; acier, chrome / verre, verre opale mat, transparent, blanc

L 725, H 1100



E27 3x 40W



9 002759 898335



### 89836 PINTO

floor light; steel, chrome / glass, matte-opal glass, clear, white

Stehleuchte; Stahl, chrom / Glas, Glas opal-matt, klar, weiss  
lampadaire; acier, chrome / verre, verre opale mat, transparent, blanc

H 1470, Ø 110, Base: Ø 230



E27 1x 40W



9 002759 898366

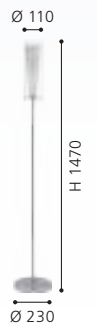



**85978**



**85977**

**85978 TROY 3**

pendant light; steel, satin nickel / satin glass, white painted  
 Hängeleuchte; Stahl, nickel-matt / Glas satiniert, weiss lackiert  
 luminaire en suspension; acier, nickel mat / verre satiné, blanc laqué

L 720, B 105, H 1100



E27



3x 40W



9 002759 859787

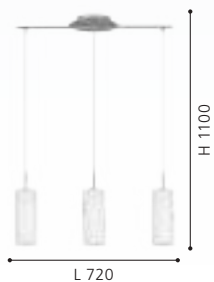

**85977 TROY 3**

pendant light; steel, satin nickel / satin glass, white painted  
 Hängeleuchte; Stahl, nickel-matt / Glas satiniert, weiss lackiert  
 luminaire en suspension; acier, nickel mat / verre satiné, blanc laqué

H 1100, Ø 110



E27



1x 40W



9 002759 859770



**85979 TROY 3**

wall light; steel, satin nickel / satin glass, white  
 Wandleuchte; Stahl, nickel-matt / Glas satiniert, weiss  
 Applique; acier, nickel mat / verre satiné, blanc laqué

L 180, H 250, A 75



E14



1x 60W



9 002759 859794





**85979**



85979



**85981**



85977 | 85978 | 85981 |  
85982

### 85981 TROY 3

table light; steel, satin nickel / satin glass, white painted  
Tischleuchte; Stahl, nickel-matt / Glas satiniert, weiss lackiert  
luminaire de table; acier, nickel mat / verre satiné, blanc laqué

H 460, Ø 105, Base: Ø 120



E27 1x 40W



9 002759 859817



### 85982 TROY 3

floor light; steel, satin nickel / satin glass, white painted  
Stehleuchte; Stahl, nickel-matt / Glas satiniert, weiss lackiert  
lampadaire; acier, nickel mat / verre satiné, blanc laqué

H 1530, Ø 105, Base: Ø 200



E27 1x 40W



9 002759 859824



**85982**



**92741**



**92742**



**92743**



92742

**92741 RIVATO**

pendant light; steel, chrome / glass with decoration, white, chrome  
 Hängeleuchte; Stahl, chrom / Glas mit Dekor, weiss, chrom  
 luminaire en suspension; acier, chrome / verre avec décor, blanc, chrome

L 705, B 90, H 1100



E27 3x 60W

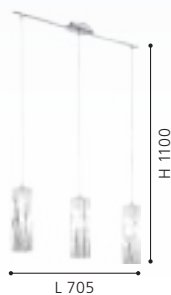

9 002759 927417

**92742 RIVATO**

wall light; steel, white, chrome / glass with decoration, white, chrome  
 Wandleuchte; Stahl, weiss, chrom / Glas mit Dekor, weiss, chrom  
 Applique; acier, blanc, chrome / verre avec décor, blanc, chrome

L 180, H 250, A 80



E14 1x 42W



9 002759 927424

**92743 RIVATO**

table light; glass, plastic, white, chrome  
 Tischleuchte; Glas, Kunststoff, weiss, chrom  
 luminaire de table; verre, plastique, blanc, chrome

H 260, Ø 90

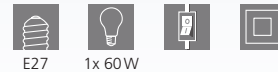

E27 1x 60W

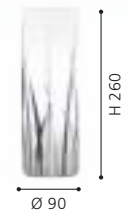

9 002759 927431



**92563**



92741 | 92743  
91971 | 92563



**91971**

### 92563 BAYMAN

pendant light; steel, chrome / glass, white, chrome  
Hängeleuchte; Stahl, chrom / Glas, weiss, chrom  
luminaire en suspension; acier, chrome / verre, blanc, chrome

L 720, B 105, H 1100

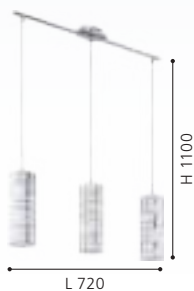

### 91971 BAYMAN

table light; glass, plastic, white, chrome  
Tischleuchte; Glas, Kunststoff, weiss, chrom  
luminaire de table; verre, plastique, blanc, chrome

H 270, Ø 105

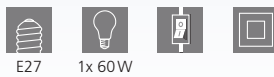



91433



91004

### 91433 VINOVO

pendant light; steel, dark brown / alabaster glass, white  
 Hängeleuchte; Stahl, dunkelbraun / Glas alabaster, weiss  
 luminaire en suspension; acier, marron foncé / verre albâtre, blanc

L 770, B 250, H 1100



E27



2x 60W



9 002759 914332



### 91004 MURCIA

pendant light; steel, black / alabaster glass, white  
 Hängeleuchte; Stahl, schwarz / Glas alabaster, weiss  
 luminaire en suspension; acier, noir / verre albâtre, blanc

L 680, H 1100



E27



2x 60W



9 002759 910044

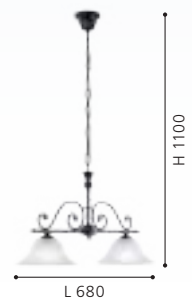



91002



91006



### MURCIA, VINOVO

These luminaires come with high quality processed alabaster glass.

Diese Leuchten sind mit hochwertigem Alabasterglas ausgestattet.

Ces luminaires viennent avec un abat-jour en verre d'albâtre haut de gamme.

### 91002 MURCIA

pendant light; steel, black / alabaster glass, white  
Hängeleuchte; Stahl, schwarz / Glas alabaster, weiss  
luminaire en suspension; acier, noir / verre albâtre, blanc

H 1100, Ø 380

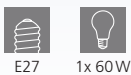

9 002759 910020

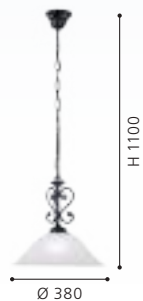

### 91006 MURCIA

wall light; steel, black / alabaster glass, white  
Wandleuchte; Stahl, schwarz / Glas alabaster, weiss  
Applique; acier, noir / verre albâtre, blanc

L 165, H 190, A 230



9 002759 910068





82748



82749



DESIGN  
HIGHLIGHT  
DETAIL

### 82748 SAVOY

pendant light; cast metal, bronzed / satin glass, white  
Hängeleuchte; Metallguss, brüniert / Glas satiniert, weiss  
luminaire en suspension; fonte métallique, brun / verre satiné, blanc

H 1100, Ø 740

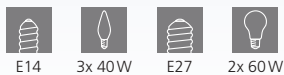

9 002759 827489



### 82749 SAVOY

pendant light; cast metal, bronzed / satin glass, white  
Hängeleuchte; Metallguss, brüniert / Glas satiniert, weiss  
luminaire en suspension; fonte métallique, brun / verre satiné, blanc

H 1100, Ø 740



9 002759 827496







82751



82752



82747



### 82751 SAVOY

wall light; cast metal, bronzed / satin glass, white  
Wandleuchte; Metallguss, brüniert / Glas satiniert, weiss  
Applique; fonte métallique, brun / verre satiné, blanc

L 180, H 160, A 240



E14 1x 40W



9 002759 827519



### 82752 SAVOY

wall light; cast metal, bronzed / satin glass, white  
Wandleuchte; Metallguss, brüniert / Glas satiniert, weiss  
Applique; fonte métallique, brun / verre satiné, blanc

L 410, H 160, A 210



E14 2x 40W



9 002759 827526



### 82747 SAVOY

pendant light; cast metal, bronzed / satin glass, white  
Hängeleuchte; Metallguss, brüniert / Glas satiniert, weiss  
luminaire en suspension; fonte métallique, brun / verre satiné, blanc

H 1100, Ø 310



E27 2x 60W



9 002759 827472

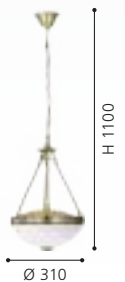



**85856**



**85857**



**85859**

### 85856 MARBELLA

ceiling light; cast metal, bronzed / alabaster glass, champagne  
Deckenleuchte; Metallguss, brüniert / Glas alabaster, champagner  
plafonnier; fonte métallique, brun / verre albâtre, champagne

H 410, Ø 370



E14 3x 60W



9 002759 858568

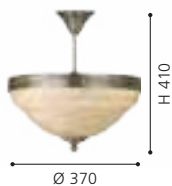

### 85857 MARBELLA

pendant light; cast metal, bronzed / alabaster glass, champagne  
Hängeleuchte; Metallguss, brüniert / Glas alabaster, champagner  
luminaire en suspension; fonte métallique, brun / verre albâtre, champagne

H 1100, Ø 740



E14 6x 60W



9 002759 858575



### 85859 MARBELLA

wall light; cast metal, bronzed / alabaster glass, champagne  
Wandleuchte; Metallguss, brüniert / Glas alabaster, champagner  
applique; fonte métallique, brun / verre albâtre, champagne

L 170, H 200, A 230



E14 1x 40W



9 002759 858599





**85858**

### 85858 MARBELLA

pendant light; cast metal, bronzed / alabaster glass, champagne  
 Hängeleuchte; Metallguss, brüniert / Glas alabaster, champagner  
 luminaire en suspension; fonte métallique, brun / verre albâtre, champagne

H 1100, Ø 740



### MARBELLA

These luminaires come with high quality processed alabaster glass.

Diese Leuchten sind mit hochwertigem Alabasterglas ausgestattet.

Ces luminaires viennent avec un abat-jour en verre d'albâtre haut de gamme.



98874

LED

98875

LED

98876

LED

### 98876 ERVIDEL

pendant light; steel, black / plastic, satin finish  
Hängeleuchte; Stahl, schwarz / Kunststoff, satiniert  
luminaire en suspension; acier, noir / plastique, satiné

L 930, B 60, H 1100

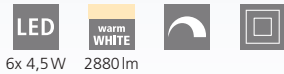

6x 4,5W 2880lm



9 002759 988760

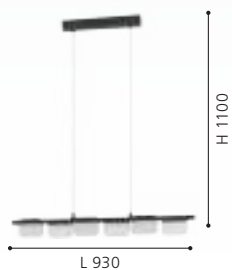

### 98874 ERVIDEL

ceiling light; steel, black / plastic, satin finish  
Deckenleuchte; Stahl, schwarz / Kunststoff, satiniert  
plafonnier; acier, noir / plastique, satiné

L 625, B 60, H 160



4x 4,5W 1920lm



9 002759 988746



### 98875 ERVIDEL

ceiling light; steel, black / plastic, satin finish  
Deckenleuchte; Stahl, schwarz / Kunststoff, satiniert  
plafonnier; acier, noir / plastique, satiné

L 930, B 60, H 160



6x 4,5W 2880lm



9 002759 988753





98878

LED



98877

LED

### 98878 ERVIDEL

table light; steel, black / plastic, satin finish  
Tischleuchte; Stahl, schwarz / Kunststoff, satiniert  
luminaire de table; acier, noir / plastique, satiné

L 155, B 60, H 500, Base: B 180, T 180



2x 4,5W 960lm



9 002759 988784



### 98877 ERVIDEL

wall light; steel, black / plastic, satin finish  
Wandleuchte; Stahl, schwarz / Kunststoff, satiniert  
Applique; acier, noir / plastique, satiné

L 320, H 90, A 80



2x 4,5W 960lm



9 002759 988777





900351



900352



### 900351 CLAVELLINA

ceiling light; steel, black / plastic, white  
 Deckenleuchte; Stahl, schwarz / Kunststoff, weiss  
 plafonnier; acier, noir / plastique, blanc

L 890, B 465, H 185



4x 6,8W 3200lm



9 008606 241088



### 900352 CLAVELLINA

pendant light; steel, black / plastic, white  
 Hängeleuchte; Stahl, schwarz / Kunststoff, weiss  
 luminaire en suspension; acier, noir / plastique, blanc

L 1200, B 400, H 1100



6x 7W 4800lm



9 008606 241095

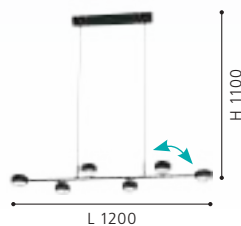

### 900353 CLAVELLINA

table light; steel, black / plastic, white  
 Tischleuchte; Stahl, schwarz / Kunststoff, weiss  
 luminaire de table; acier, noir / plastique, blanc

L 550, H 450, Base: Ø 180



1x 6,8W 800lm



9 008606 241101

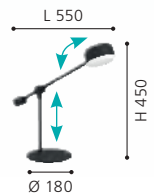



900353



### 900354 CLAVELLINA

floor light; steel, black / plastic, white  
 Stehleuchte; Stahl, schwarz / Kunststoff, weiss  
 lampadaire; acier, noir / plastique, blanc

L 1215, H 1605, Base: Ø 300

LED

24W

warm  
 WHITE

2210lm



9 008606 2435 18

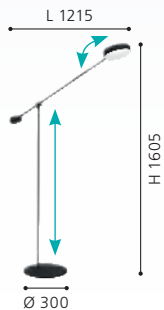

900354





99562

LED



DESIGN  
HIGHLIGHT  
DETAIL

**99562 ISIDRO**

pendant light; aluminium, steel, black / plastic, satin finish  
Hängeleuchte; Alu, Stahl, schwarz / Kunststoff, satiniert  
luminaire en suspension; aluminium, acier, noir / plastique, satiné

L 795, B 60, H 1100

LED  
27W

warm  
WHITE  
3850lm



9 002759 995621

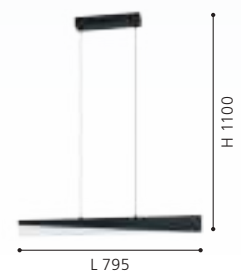





99561



99563



99564



### 99561 ISIDRO

ceiling light; aluminium, steel, black / plastic, satin finish  
Deckenleuchte; Alu, Stahl, schwarz / Kunststoff, satiniert  
plafonnier; aluminium, acier, noir / plastique, satiné

L 860, B 80, H 110



2x 11W 2700lm



9 002759 995614



### 99563 ISIDRO

wall light; aluminium, steel, black / plastic, satin finish  
Wandleuchte; Alu, Stahl, schwarz / Kunststoff, satiniert  
Applique; aluminium, acier, noir / plastique, satiné

L 395, H 80, A 70



9W 1050lm



9 002759 995638



### 99564 ISIDRO

table light; aluminium, steel, black / plastic, satin finish  
Tischleuchte; Alu, Stahl, schwarz / Kunststoff, satiniert  
luminaire de table; aluminium, acier, noir / plastique, satiné

L 70, B 15, H 410, Base: B 150, T 130



9W 1050lm



9 002759 995645





900563

LED



**CARANACOA**

These luminaires have swiveling light rings.  
 Diese Leuchten verfügen über schwenkbare Leuchtringe.  
 Ces luminaires ont des anneaux lumineux pivotants.

**900563 CARANACOA**

pendant light; steel, black / plastic, white  
 Hängeleuchte; Stahl, schwarz / Kunststoff, weiss  
 luminaire en suspension; acier, noir / plastique, blanc

L 1170, B 230, H 1100

LED

5x 7 W

warm  
WHITE

7000lm



9 008606 244652

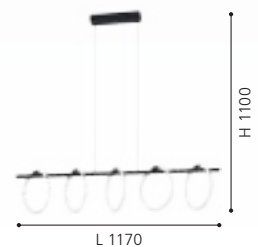



900562



900564



900565



### 900562 CARANACOA

pendant light; steel, black / plastic, white  
 Hängeleuchte; Stahl, schwarz / Kunststoff, weiss  
 luminaire en suspension; acier, noir / plastique, blanc

L 780, B 230, H 1100



3x 9W 3600lm



9 008606 244645



### 900564 CARANACOA

wall light; steel, black / plastic, white  
 Wandleuchte; Stahl, schwarz / Kunststoff, weiss  
 Applique; acier, noir / plastique, blanc

L 260, H 260, A 45



11,5W 1500lm



9 008606 244669



### 900565 CARANACOA

table light; steel, black / plastic, white  
 Tischleuchte; Stahl, schwarz / Kunststoff, weiss  
 luminaire de table; acier, noir / plastique, blanc

L 260, B 50, H 260, Base: Ø 100



11,5W 1500lm



9 008606 244676





900917

LED



900916

LED

### 900917 VALLEROSA

pendant light; aluminium, steel, brushed brass / plastic, white  
Hängeleuchte; Alu, Stahl, messing-gebürstet / Kunststoff, weiss  
luminaire en suspension; aluminium, acier, laiton brossé /  
plastique, blanc

H 1100, Ø 580

LED

25,2 W

warm  
WHITE

3000 lm





900918

LED



900919

LED



### 900916 VALLEROSA

ceiling light; aluminium, steel, brushed brass / plastic, white  
Deckenleuchte; Alu, Stahl, messing-gebürstet / Kunststoff, weiss  
plafonnier; aluminium, acier, laiton brossé / plastique, blanc

L 580, B 335, H 75



25,2W 3000lm



9 008606 277810



### 900918 VALLEROSA

table light; aluminium, steel, brushed brass / plastic, white  
Tischleuchte; Alu, Stahl, messing-gebürstet / Kunststoff, weiss  
luminaire de table; aluminium, acier, laiton brossé / plastique, blanc

L 220, H 425, Base: Ø 130



10,8W 1300lm



9 008606 277834



### 900919 VALLEROSA

floor light; aluminium, steel, brushed brass / plastic, white  
Stehleuchte; Alu, Stahl, messing-gebürstet / Kunststoff, weiss  
lampadaire; aluminium, acier, laiton brossé / plastique, blanc

L 290, H 1285, Base: Ø 200



25,2W 3400lm



9 008606 277841





99358



900631



900632



### 99358 CODRIALES

pendant light; steel, black / plastic, white  
Hängeleuchte; Stahl, schwarz / Kunststoff, weiss  
luminaire en suspension; acier, noir / plastique, blanc

L 780, B 300, H 1100



27W



4000lm



9 002759 993580



### 900631 CODRIALES

ceiling light; aluminium, black / plastic, white  
Deckenleuchte; Alu, schwarz / Kunststoff, weiss  
plafonnier; aluminium, noir / plastique, blanc

L 790, B 300, H 116



27W



4000lm



9 008606 241040



### 900632 CODRIALES

wall light; aluminium, black / plastic, white  
Wandleuchte; Alu, schwarz / Kunststoff, weiss  
Applique; aluminium, noir / plastique, blanc

L 180, H 320, A 65



10,8W



1400lm



9 008606 241057





900633



### 900633 CODRIALES

table light; aluminium, black / plastic, white  
Tischleuchte; Alu, schwarz / Kunststoff, weiss  
luminaire de table; aluminium, noir / plastique, blanc

L 205, B 80, H 380

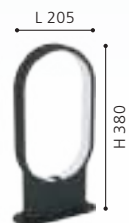



900948

LED



900951

LED

### 900948 GIANELLA

pendant light; aluminium, steel, black / plastic, white  
 Hängeleuchte; Alu, Stahl, schwarz / Kunststoff, weiss  
 luminaire en suspension; aluminium, acier, noir / plastique, blanc

L 1150, B 375, H 1100

LED warm WHITE

36W 3960lm



9 008606 275014

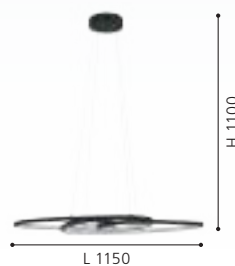

### 900951 GIANELLA

table light; aluminium, steel, black / plastic, white  
 Tischleuchte; Alu, Stahl, schwarz / Kunststoff, weiss  
 luminaire de table; aluminium, acier, noir / plastique, blanc

L 220, B 130, H 400, Base: Ø 130

LED warm WHITE

12W 1100lm



9 008606 275038

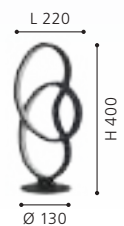





900947

LED



900949

LED



901015

LED

### 900947 GIANELLA

ceiling light; aluminium, steel, black / plastic, white  
Deckenleuchte; Alu, Stahl, schwarz / Kunststoff, weiss  
plafonnier; aluminium, acier, noir / plastique, blanc

L 880, B 335, H 210



36W 3960lm



9 008606 275007



L 880

B 335

### 900949 GIANELLA

wall light; aluminium, steel, black / plastic, white  
Wandleuchte; Alu, Stahl, schwarz / Kunststoff, weiss  
Applique; aluminium, acier, noir / plastique, blanc

L 365, B 240, A 100



12W 1100lm



9 008606 275021



L 365

B 240

### 901015 GIANELLA

floor light; aluminium, steel, black / plastic, white  
Stehleuchte; Alu, Stahl, schwarz / Kunststoff, weiss  
lampadaire; aluminium, acier, noir / plastique, blanc

L 250, B 300, H 1025, Base: Ø 250



40W 3700lm



9 008606 291489

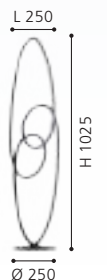

Ø 250

H 1025



900465



900466



### 900465 SIBERIA

ceiling light; steel, black / plastic, white  
Deckenleuchte; Stahl, schwarz / Kunststoff, weiss  
plafonnier; acier, noir / plastique, blanc

L 780, B 160, H 235

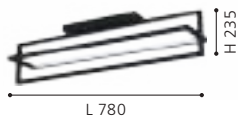

### 900466 SIBERIA

pendant light; steel, black / plastic, white  
Hängeleuchte; Stahl, schwarz / Kunststoff, weiss  
luminaire en suspension; acier, noir / plastique, blanc

L 780, B 160, H 1100

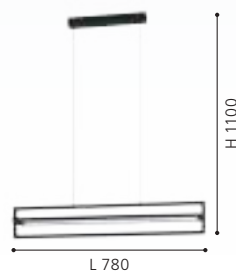

### 900467 SIBERIA

wall light; steel, black / plastic, white  
Wandleuchte; Stahl, schwarz / Kunststoff, weiss  
applique; acier, noir / plastique, blanc

L 160, H 300, A 190





900467



900468



900469



### 900468 SIBERIA

table light; steel, black / plastic, white  
Tischleuchte; Stahl, schwarz / Kunststoff, weiss  
luminaire de table; acier, noir / plastique, blanc

L 160, B 160, H 430, Base: B 160, T 160



15,5W 2200lm



9 008606 244072



### 900469 SIBERIA

floor light; steel, black / plastic, white  
Stehleuchte; Stahl, schwarz / Kunststoff, weiss  
lampadaire; acier, noir / plastique, blanc

L 200, B 160, H 1330, Base: B 200, T 160



34W 4600lm



9 008606 244089

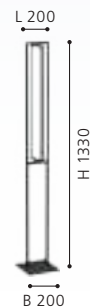



99799

LED



99801

LED

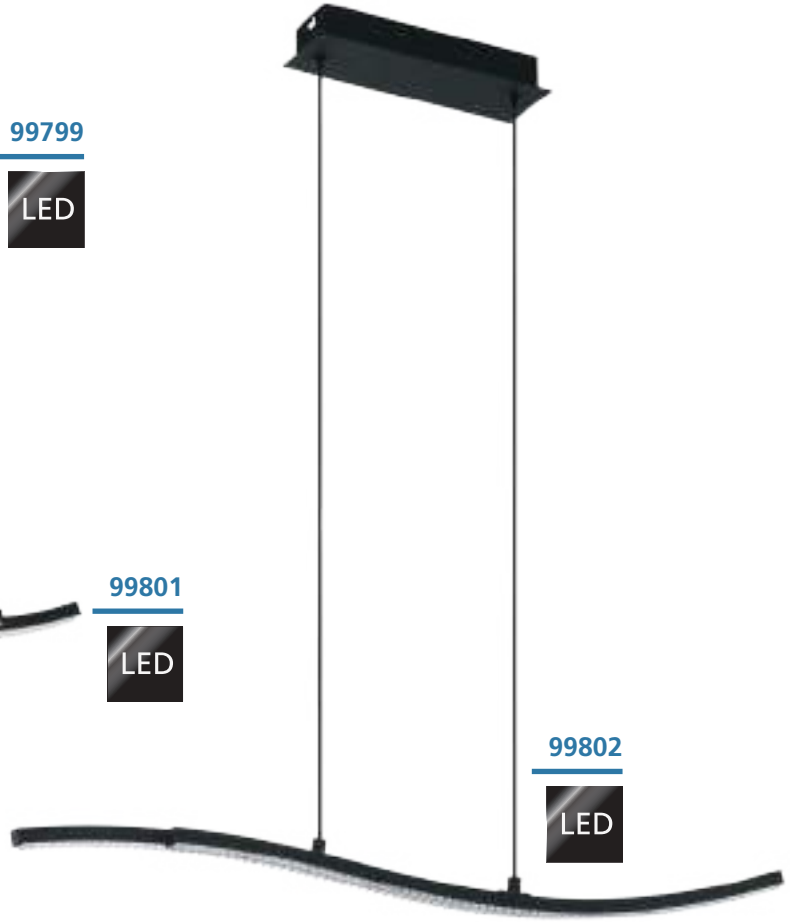

99802

LED

### 99799 LEJIAS

ceiling light; steel, black / plastic, transparent  
 Deckenleuchte; Stahl, schwarz / Kunststoff, transparent  
 plafonnier; acier, noir / plastique, transparent

L 450, B 450, H 75



21W 3050lm



9 002759 997991

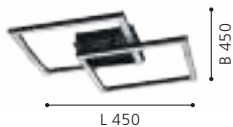

### 99801 LEJIAS

ceiling light; steel, black / plastic, transparent  
 Deckenleuchte; Stahl, schwarz / Kunststoff, transparent  
 plafonnier; acier, noir / plastique, transparent

L 780, B 80



21,5W 2600lm



9 002759 998011



### 99802 LEJIAS

pendant light; steel, black / plastic, transparent  
 Hängeleuchte; Stahl, schwarz / Kunststoff, transparent  
 luminaire en suspension; acier, noir / plastique, transparent

L 780, B 80, H 1750



21,5W 2600lm



9 002759 998028

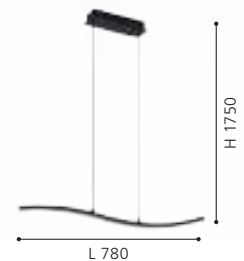



99803



99804



99805



### 99803 LEJIAS

wall light; steel, black / plastic, transparent  
Wandleuchte; Stahl, schwarz / Kunststoff, transparent  
Applique; acier, noir / plastique, transparent

L 90, H 285



8W 1050lm



9 002759 998035



### 99804 LEJIAS

table light; steel, black / plastic, transparent  
Tischleuchte; Stahl, schwarz / Kunststoff, transparent  
luminaire de table; acier, noir / plastique, transparent

H 330, Base: B 140, T 140



8W 900lm



9 002759 998042



### 99805 LEJIAS

floor light; steel, black / plastic, transparent  
Stehleuchte; Stahl, schwarz / Kunststoff, transparent  
lampadaire; acier, noir / plastique, transparent

H 1230, Base: B 230, T 230



16W 2050lm



9 002759 998059



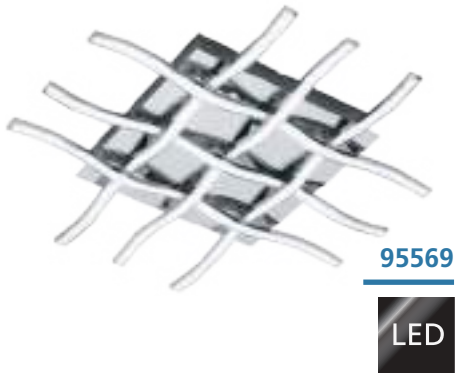

95569

LED



96104

LED



96102

LED

### 95569 LASANA 1

wall/ceiling light; steel, chrome / plastic, white  
Wand- / Deckenleuchte; Stahl, chrom / Kunststoff, weiss  
Applique/Plafonnier; acier, chrome / plastique, blanc

L 500, B 500, H 65

LED

warm  
WHITE



6x 6W 4860lm



9 002759 955694

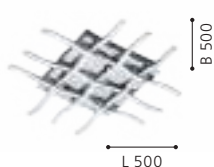

### 96104 LASANA 2

pendant light; steel, aluminium, chrome / plastic, white  
Hängeleuchte; Stahl, Alu, chrom / Kunststoff, weiss  
luminaire en suspension; acier, aluminium, chrome / plastique, blanc

L 1200, B 80, H 1200

LED

warm  
WHITE



2x 13W 3400lm



9 002759 961046

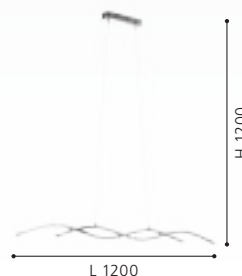

### 96102 LASANA 2

pendant light; steel, aluminium, chrome / plastic, white  
Hängeleuchte; Stahl, Alu, chrom / Kunststoff, weiss  
luminaire en suspension; acier, aluminium, chrome / plastique, blanc

L 1000, B 80, H 1200

LED

warm  
WHITE



35W 5300lm



9 002759 961022

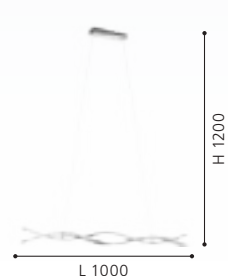

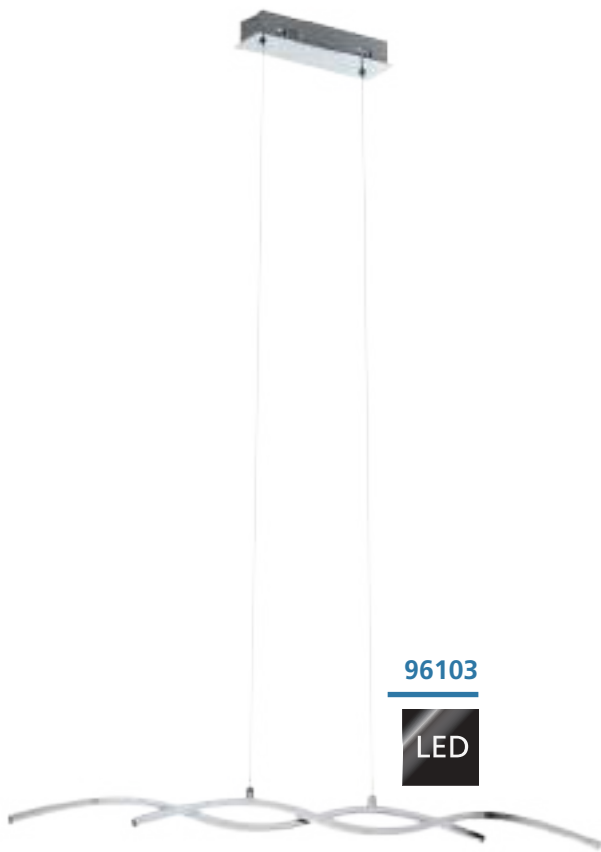

96103



96105



96106



### 96103 LASANA 2

pendant light; steel, aluminium, chrome / plastic, white  
 Hängeleuchte; Stahl, Alu, chrom / Kunststoff, weiss  
 luminaire en suspension; acier, aluminium, chrome / plastique, blanc

L 870, B 80, H 1200



19W 2600lm



9 002759 961039

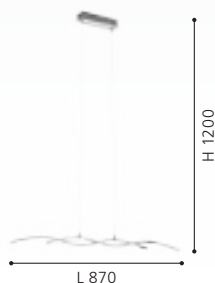

### 96105 LASANA 2

table light; steel, aluminium, chrome / plastic, white  
 Tischleuchte; Stahl, Alu, chrom / Kunststoff, weiss  
 luminaire de table; acier, aluminium, chrome / plastique, blanc

L 160, B 100, H 460



2x 5,5W 1440lm



9 002759 961053



### 96106 LASANA 2

floor light; steel, aluminium, chrome / plastic, white  
 Stehleuchte; Stahl, Alu, chrom / Kunststoff, weiss  
 lampadaire; acier, aluminium, chrome / plastique, blanc

L 250, B 130, H 1420



36W 4700lm



9 002759 961060



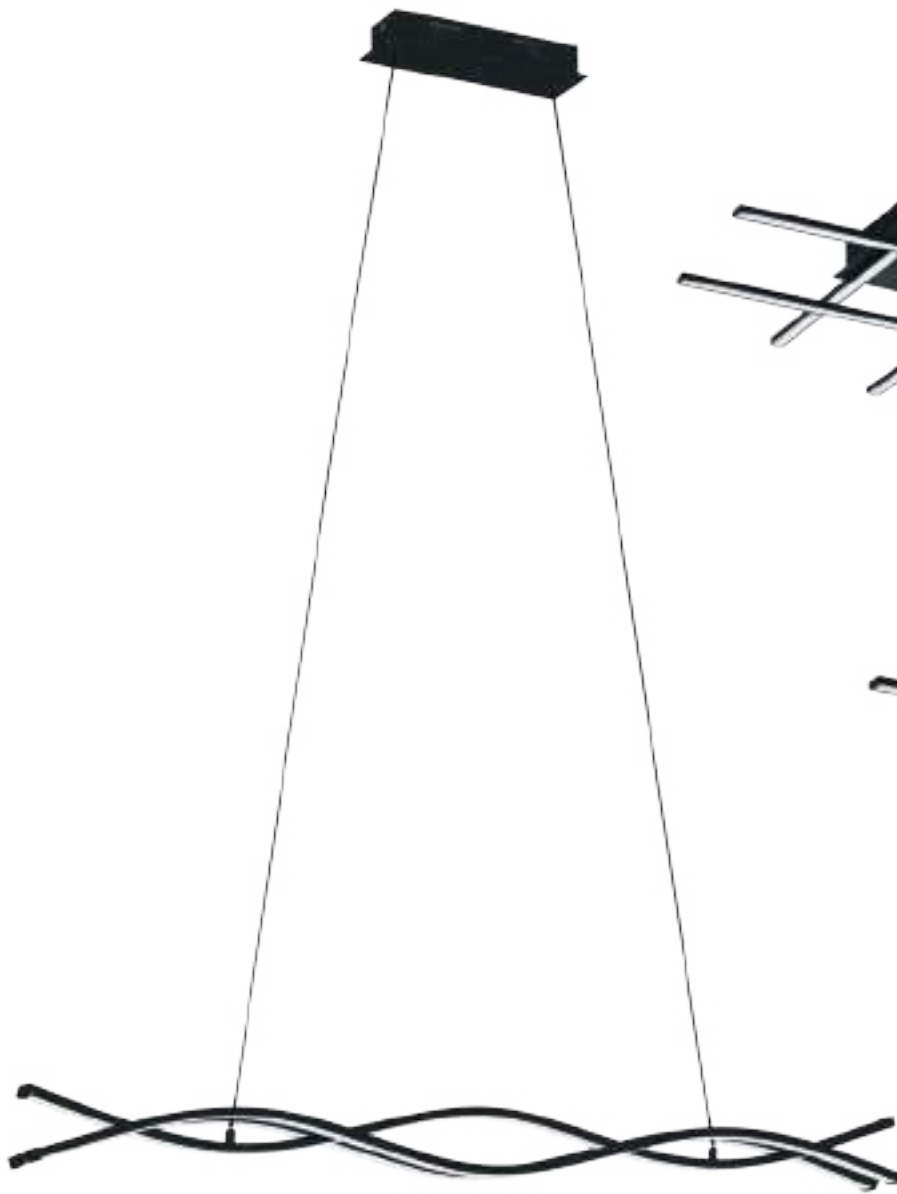

99317



99316



99315



### 99317 LASANA 3

pendant light; steel, aluminium, black / plastic, white  
Hängeleuchte; Stahl, Alu, schwarz / Kunststoff, weiss  
luminaire en suspension; acier, aluminium, noir / plastique, blanc

L 985, B 80, H 1200



33W 4500lm



9 002759 993177

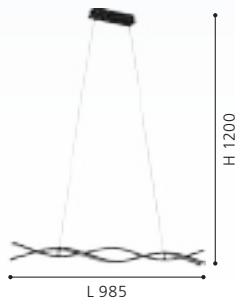

### 99316 LASANA 3

wall/ceiling light; steel, aluminium, black / plastic, white  
Wand- / Deckenleuchte; Stahl, Alu, schwarz / Kunststoff, weiss  
Applique/Plafonnier; acier, aluminium, noir / plastique, blanc

L 500, B 500, H 95



4x 5,3W 2800lm



9 002759 993160



### 99315 LASANA 3

wall/ceiling light; steel, aluminium, black / plastic, white  
Wand- / Deckenleuchte; Stahl, Alu, schwarz / Kunststoff, weiss  
Applique/Plafonnier; acier, aluminium, noir / plastique, blanc

L 500, B 145, H 90



3x 3,5W 1500lm



9 002759 993153







99319

LED



99318

LED

### 99319 LASANA 3

floor light; steel, aluminium, black / plastic, white  
 Stehleuchte; Stahl, Alu, schwarz / Kunststoff, weiss  
 lampadaire; acier, aluminium, noir / plastique, blanc

L 250, B 130, H 1420, Base: B 230, T 150



36W 4700lm



9 002759 993191



### 99318 LASANA 3

table light; steel, aluminium, black / plastic, white  
 Tischleuchte; Stahl, Alu, schwarz / Kunststoff, weiss  
 luminaire de table; acier, aluminium, noir / plastique, blanc

L 160, B 100, H 460, Base: B 180, T 100



11,5W 1280lm



9 002759 993184





95147

LED



32048

LED

### 95147 LASANA

pendant light; aluminium, steel, chrome / plastic, white  
 Hängeleuchte; Alu, Stahl, chrom / Kunststoff, weiss  
 luminaire en suspension; aluminium, acier, chrome / plastique, blanc

L 900, H 1100

LED

30W

warm  
WHITE

3500lm



9 002759 951474

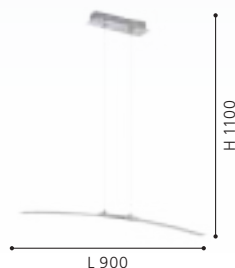

### 32048 LASANA

pendant light; aluminium, steel, chrome / plastic, white  
 Hängeleuchte; Alu, Stahl, chrom / Kunststoff, weiss  
 luminaire en suspension; aluminium, acier, chrome / plastique, blanc

L 900, H 1000

LED

15W

warm  
WHITE

1800lm



9 002759 320485

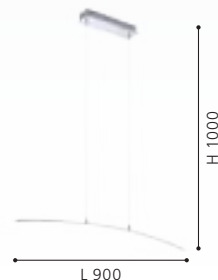



95568

LED



95567

LED



96866

LED

### 95568 LASANA 1

wall/ceiling light; steel, chrome / plastic, white  
Wand- / Deckenleuchte; Stahl, chrom / Kunststoff, weiss  
Applique/Plafonnier; acier, chrome / plastique, blanc

L 500, B 500, H 95



4x 5,3W 2800lm



9 002759 955687

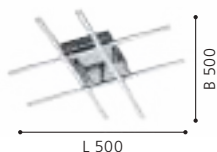

### 95567 LASANA 1

wall/ceiling light; steel, chrome / plastic, white  
Wand- / Deckenleuchte; Stahl, chrom / Kunststoff, weiss  
Applique/Plafonnier; acier, chrome / plastique, blanc

L 500, B 160, H 95



3x 3,5W 1500lm



9 002759 955670

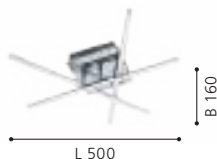

### 96866 TARANDELL

pendant light; aluminium, steel, chrome / plastic, satin finish  
Hängeleuchte; Alu, Stahl, chrom / Kunststoff, satiniert  
luminaire en suspension; aluminium, acier, chrome / plastique, satiné

L 1180, B 60, H 930 - 1620



2x 12,5W 3300lm



9 002759 968663

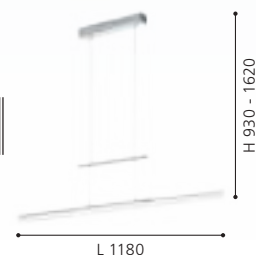



99322

LED



99321

LED



99323

LED

### 99322 RONCADE 1

wall/ceiling light; steel, aluminium, black / plastic, white  
Wand- / Deckenleuchte; Stahl, Alu, schwarz / Kunststoff, weiss  
Applique/Plafonnier; acier, aluminium, noir / plastique, blanc

L 1160, B 180, H 115

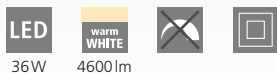

36W 4600lm

### 99321 RONCADE 1

wall/ceiling light; steel, aluminium, black / plastic, white  
Wand- / Deckenleuchte; Stahl, Alu, schwarz / Kunststoff, weiss  
Applique/Plafonnier; acier, aluminium, noir / plastique, blanc

L 650, B 130, H 45



21W 2800lm

### 99323 SELVINA 1

ceiling light; steel, aluminium, black / plastic, white  
Deckenleuchte; Stahl, Alu, schwarz / Kunststoff, weiss  
plafonnier; acier, aluminium, noir / plastique, blanc

L 690, B 300, H 115



19W 2700lm



9 002759 993221

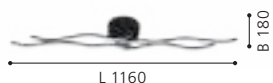

9 002759 993214



9 002759 993238





31996

LED



31995

LED



96329

LED

### 31996 RONCADE

wall/ceiling light; aluminium, steel, chrome / plastic, white  
Wand- / Deckenleuchte; Alu, Stahl, chrom / Kunststoff, weiss  
Applique/Plafonnier; aluminium, acier, chrome / plastique, blanc

L 1085, B 160, H 125



37W 4700lm

### 31995 RONCADE

wall/ceiling light; aluminium, steel, chrome / plastic, white  
Wand- / Deckenleuchte; Alu, Stahl, chrom / Kunststoff, weiss  
Applique/Plafonnier; aluminium, acier, chrome / plastique, blanc

L 650, B 130, H 45



21W 2800lm

### 96329 SELVINA

ceiling light; aluminium, chrome / plastic, white  
Deckenleuchte; Alu, chrom / Kunststoff, weiss  
plafonnier; aluminium, chrome / plastique, blanc

L 690, B 300, H 115



19W 2700lm



9 002759 319960



9 002759 319953



9 002759 963293





96308

LED

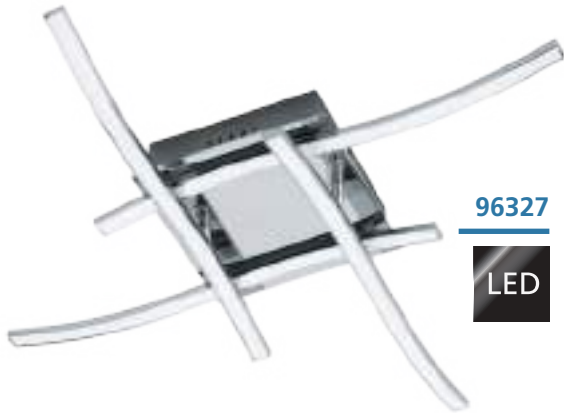

96327

LED



96326

LED

### 96308 SELVINA

ceiling light; aluminium, chrome / plastic, white  
Deckenleuchte; Alu, chrom / Kunststoff, weiss  
plafonnier; aluminium, chrome / plastique, blanc

L 745, B 175, H 85

LED

warm  
WHITE  
2900lm



9 002759 963088



### 96327 VALMORA

ceiling light; aluminium, chrome / plastic, white  
Deckenleuchte; Alu, chrom / Kunststoff, weiss  
plafonnier; aluminium, chrome / plastique, blanc

L 560, B 560, H 105

LED

warm  
WHITE  
2450lm



9 002759 963279

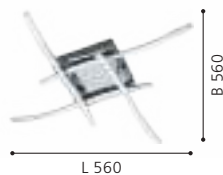

### 96326 VALMORA

ceiling light; aluminium, chrome / plastic, white  
Deckenleuchte; Alu, chrom / Kunststoff, weiss  
plafonnier; aluminium, chrome / plastique, blanc

L 590, B 125, H 90

LED

warm  
WHITE  
1700lm



9 002759 963262





96332

LED



96305

LED

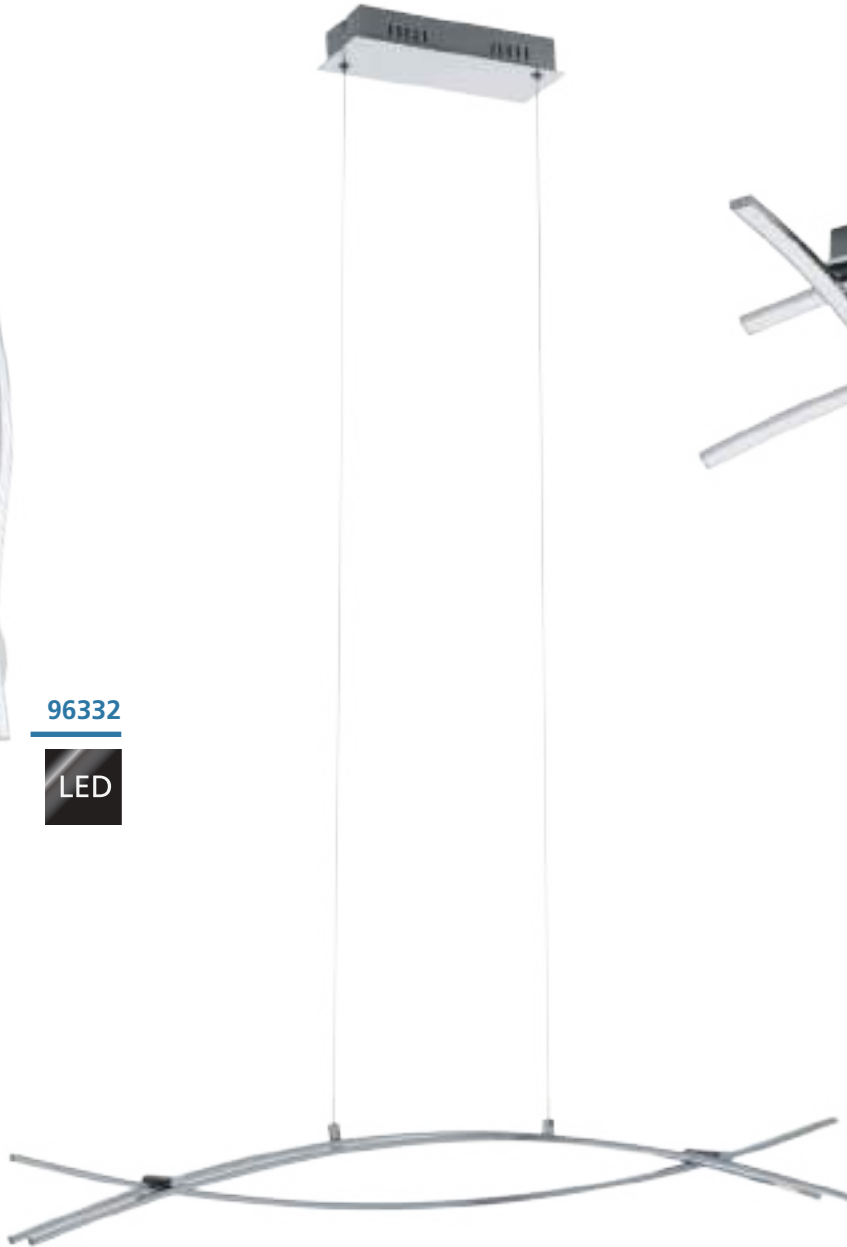

96331

LED

### 96332 VALMORA

wall light; aluminium, chrome / plastic, white  
Wandleuchte; Alu, chrom / Kunststoff, weiss  
Applique; aluminium, chrome / plastique, blanc

L 115, H 450, A 90



9W 1250lm



9 002759 963323



### 96331 NEVADO

pendant light; aluminium, chrome / plastic, white  
Hängeleuchte; Alu, chrom / Kunststoff, weiss  
luminaire en suspension; aluminium, chrome / plastique, blanc

L 900, B 80, H 1100



23,6W 3400lm



9 002759 963316

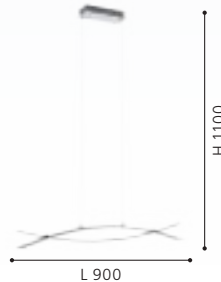

### 96305 NEVADO

ceiling light; aluminium, chrome / plastic, white  
Deckenleuchte; Alu, chrom / Kunststoff, weiss  
plafonnier; aluminium, chrome / plastique, blanc

L 500, B 500, H 115



18W 2450lm



9 002759 963057

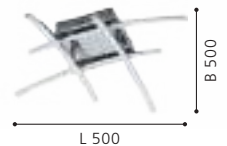



31997

LED



98889

LED



99559

LED

### 31997 RONCADE

table light; aluminium, steel, chrome / plastic, white  
Tischleuchte; Alu, Stahl, chrom / Kunststoff, weiss  
luminaire de table; aluminium, acier, chrome / plastique, blanc

L 195, B 150, H 335

LED

warm  
WHITE



8,8W

866lm

### 98889 PALOZZA 1

wall light; aluminium, satin nickel / plastic, white  
Wandleuchte; Alu, nickel-matt / Kunststoff, weiss  
Applique; aluminium, nickel mat / plastique, blanc

L 170, H 425, A 60

LED

warm  
WHITE



10W

1300lm

### 99559 PALOZZA 1

table light; aluminium, satin nickel / plastic, white  
Tischleuchte; Alu, nickel-matt / Kunststoff, weiss  
luminaire de table; aluminium, nickel mat / plastique, blanc

L 150, B 110, H 420

LED

warm  
WHITE



11W

1400lm



9 002759 319977

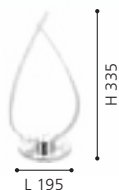

L 195

H 335



9 002759 988890



L 170

H 425



9 002759 995591



L 150

H 420





96306

LED



97361

LED

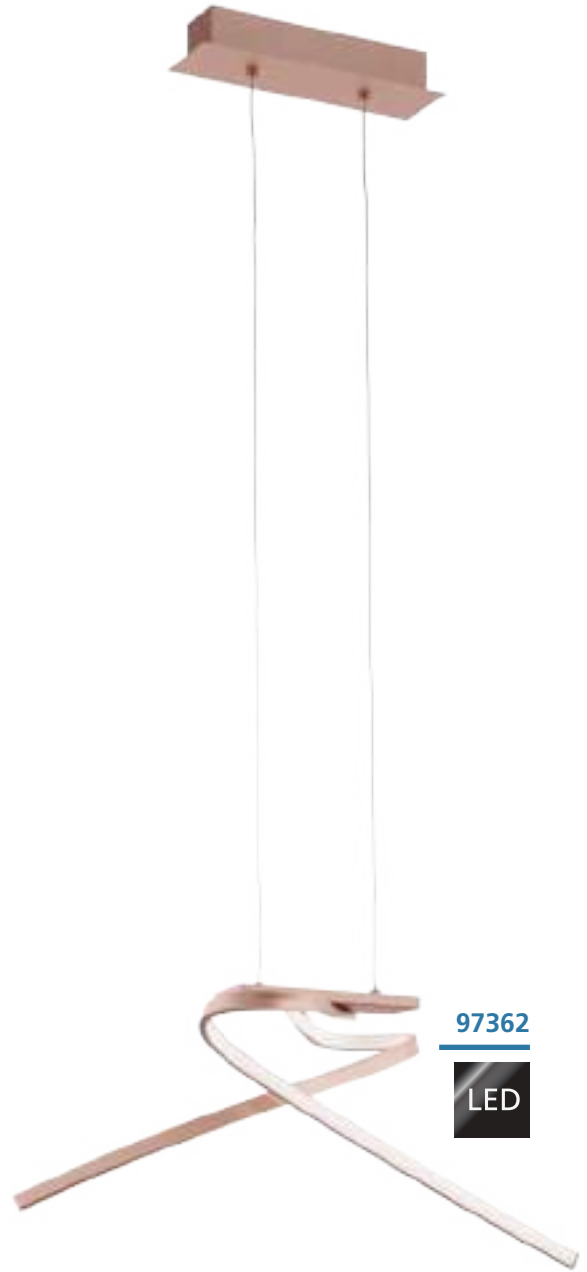

97362

LED

### 96306 SELVINA

ceiling light; aluminium, chrome / plastic, white  
Deckenleuchte; Alu, chrom / Kunststoff, weiss  
plafonnier; aluminium, chrome / plastique, blanc

L 460, B 390, H 380



28W 3600lm



9 002759 963064

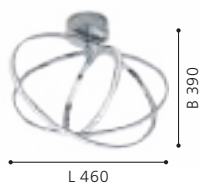

### 97361 PALOZZA

ceiling light; aluminium, rose gold / plastic, white  
Deckenleuchte; Alu, roségold / Kunststoff, weiss  
plafonnier; aluminium, rose or / plastique, blanc

L 705, B 315, H 125



19W 2700lm



9 002759 973612

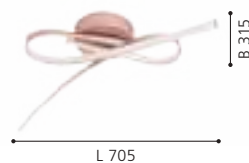

### 97362 PALOZZA

pendant light; aluminium, rose gold / plastic, white  
Hängeleuchte; Alu, roségold / Kunststoff, weiss  
luminaire en suspension; aluminium, rose or / plastique, blanc

L 705, B 315, H 1100



19W 2600lm



9 002759 973629

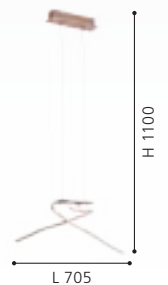



# LIGHTING FAMILIES / GLASS CHANDELIERS

LEUCHTENFAMILIEN / GLASLUSTER  
FAMILLES DE LUMINAIRES / LUSTRES EN VERRE



**EN SPARKLING**

Extravagant lighting – our glass chandeliers will give you light in a new diversity while ensuring an extraordinary ambience. Our chandeliers are true jewels on your ceiling and spread their elegance in your entire living area.

**DE FUNKELN**

Beleuchtung der Extravaganz – Mit unseren Glaslustern erleben Sie Licht in neuer Vielfalt und sorgen für ein außergewöhnliches Ambiente. Unsere Kronleuchter werden zum wahren Schmuckstück und bringen Eleganz in all Ihre Wohnbereiche.

**FR DU SCINTILLEMENT**

Un éclairage riche en extravagance – Avec nos lustres en verre, vous faites l'expérience de la lumière dans une nouvelle multiplicité et vous assurez une ambiance extraordinaire. Nos plafonniers lustres en deviennent de vrais bijoux et prêtent de l'élégance à tous vos espaces d'habitat.





# OVERVIEW

LIGHTING FAMILIES / GLAS CHANDELIERS  
LEUCHTENFAMILIEN / GLASLUSTER  
FAMILLES DE LUMINAIRES / LUSTRES EN VERRE



BASILANO 1  
**340-341**



BASILANO  
**342-343**



CARPENTIO  
**344**



This product is available in different colors and shapes. / Dieser Artikel ist in unterschiedlichen Farben und Formen verfügbar. /  
Cet article est disponible en différentes couleurs et formes.





39103



39101

### 39103 BASILANO 1

pendant light; steel, chrome / glass, clear  
 Hängeleuchte; Stahl, chrom / Glas, klar  
 luminaire en suspension; acier, chrome / verre, transparent

H 1500, Ø 1000



E14 18x 40W



9 002759 391034

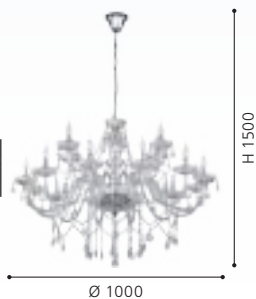

H 1500

Ø 1000

### 39101 BASILANO 1

pendant light; steel, chrome / glass, clear  
 Hängeleuchte; Stahl, chrom / Glas, klar  
 luminaire en suspension; acier, chrome / verre, transparent

H 1300, Ø 820



E14 8x 40W



9 002759 391010



H 1300

Ø 820

### 39099 BASILANO 1

pendant light; steel, chrome / glass, clear  
 Hängeleuchte; Stahl, chrom / Glas, klar  
 luminaire en suspension; acier, chrome / verre, transparent

H 1300, Ø 720

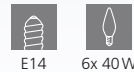

E14 6x 40W



9 002759 390990

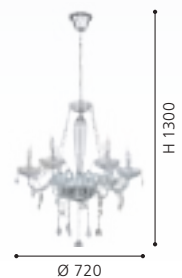

H 1300

Ø 720



39099



39102

### 39102 BASILANO 1

pendant light; steel, chrome / glass, clear

Hängeleuchte; Stahl, chrom / Glas, klar

luminaire en suspension; acier, chrome / verre, transparent

H 1500, Ø 1000



E14



12x 40W



9 002759 391027



H 1500

Ø 1000



39095



39092

### 39095 BASILANO

pendant light; steel, chrome / glass, cognac  
 Hängeleuchte; Stahl, chrom / Glas, cognac  
 luminaire en suspension; acier, chrome / verre, cognac

H 1500, Ø 1000



E14 18x 40W



9 002759 390952



### 39092 BASILANO

pendant light; steel, chrome / glass, cognac  
 Hängeleuchte; Stahl, chrom / Glas, cognac  
 luminaire en suspension; acier, chrome / verre, cognac

H 1300, Ø 720



E14 6x 40W



9 002759 390921







39093



39094

### 39093 BASILANO

pendant light; steel, chrome / glass, cognac  
 Hängeleuchte; Stahl, chrom / Glas, cognac  
 luminaire en suspension; acier, chrome / verre, cognac

H 1300, Ø 820



E14 8x 40W



9 002759 390938



H 1300

Ø 820

### 39094 BASILANO

pendant light; steel, chrome / glass, cognac  
 Hängeleuchte; Stahl, chrom / Glas, cognac  
 luminaire en suspension; acier, chrome / verre, cognac

H 1500, Ø 1000



E14 12x 40W



9 002759 390945



H 1500

Ø 1000



**39113**

### 39113 CARPENTO

pendant light; steel, chrome / glass, white  
 Hängeleuchte; Stahl, chrom / Glas, weiss  
 luminaire en suspension; acier, chrome / verre, blanc

H 1200, Ø 590



E14

5x 40W



9 002759 391133



H 1200

Ø 590

### 39114 CARPENTO

pendant light; steel, chrome / glass, white  
 Hängeleuchte; Stahl, chrom / Glas, weiss  
 luminaire en suspension; acier, chrome / verre, blanc

H 1300, Ø 700



E14

8x 40W



9 002759 391140



H 1300

Ø 700



39114





# HANGING & PENDANT LUMINAIRES

HÄNGE- & PENDELLEUCHTEN  
LUMINAIRES SUSPENSIONS



**EN** **SUSPENDED LIGHTING**

Our wide variety of suspended and pendant luminaires contain classical as well as extravagant designs and supply any furnishing style. Set beautiful accents with your favourites and give your home a special atmosphere.

**DE** **BELEUCHTUNG ZUM ABHÄNGEN**

Unser breitgefächertes Hänge- und Pendelleuchten-Sortiment beinhaltet sowohl klassische als auch extravagante Designs und bedient jeden Einrichtungsstil. Setzen Sie mit Ihren Favoriten schöne Akzente und verleihen Sie Ihrem Zuhause eine besondere Atmosphäre.

**FR** **ÉCLAIRAGES SUSPENDUS**

Notre large gamme d'éclairages suspendus et pendulaires comprend aussi bien des designs classiques qu'extravagants et est adaptée à tout style d'ameublement. Mettez avec vos favoris de beaux accents et donnez une atmosphère particulière à votre intérieur.





# OVERVIEW

HANGING & PENDANT LUMINAIRES  
HÄNGE- & PENDELLEUCHTEN  
LUMINAIRES SUSPENSIONS

 OIELLA 350-351	 AGUILARES 353	 LEBALIO 353	 MARYVILLA 354	 ALOBRASE 355, 358-361	 BATISTA 355	 CAPRAROLA 356	 COMINIO 357
 CADAQUES 361	 CADAQUES 1 361	 ARISCANI 362-363	 MURMILLO 364	 FARSALA 365	 MANTUNALLE 1 367	 BELESER 367	 MANTUNALLE 368
 SELVINO 370-371	 ALBARACCIN 372-373	 LAGUNITAS 374	 CERASELLA 375	 ROCAMAR 376,378	 ROCAMAR 1 377-378	 CORETTO 377	 LONCINO 1 379
 ALEANDRO 1 380	 ROMAGNESE 380	 VALLASPRA 381	 BATISTA 3 381	 BOLSANO 382	 CLEMENTE 383	 CARDITO 1 384-385	 VARRAZO 385
 LUBERIO 386	 MONTEFIO 1 386-387	 MIOGLIA 1 388	 CONESSA 388-389	 CARTAMA 391	 MONTEFINO 392	 CORTENOVA 394	 POZUETA 1 397
 POZUETA 399	 BOCADELLA 400	 MEZZANA 400	 GRADOLI 402	 GRADOLI 1 403	 MANIZALES 403	 CUMIOLE 404	 MONTEBALDO 405
 BITACHITO 405	 CORTADERAS 406	 RONDO 3 407	 PINETINA 407	 NARICES 407	 SARONA 408	 LOBATIA 409	 SILVARES 410



This product is available in different colors and shapes. / Dieser Artikel ist in unterschiedlichen Farben und Formen verfügbar. / Cet article est disponible en différentes couleurs et formes.





### 99614 OIELLA

pendant light; steel, black, brass / glass vaporized, black-brown-transparent

Hängeleuchte; Stahl, schwarz, messing / Glas bedampft, schwarz-braun-transparent

luminaire en suspension; acier, noir, laiton / verre vaporisé, noir marron transparent

H 1100, Ø 190



E27

1x 40W



9 002759 996147



### 99615 OIELLA

pendant light; steel, black, brass / glass vaporized, black-brown-transparent

Hängeleuchte; Stahl, schwarz, messing / Glas bedampft, schwarz-braun-transparent

luminaire en suspension; acier, noir, laiton / verre vaporisé, noir marron transparent

L 950, B 190, H 1100



E27

3x 40W



9 002759 996154



### 99616 OIELLA

pendant light; steel, black, brass / glass vaporized, black-grey-transparent

Hängeleuchte; Stahl, schwarz, messing / Glas bedampft, schwarz-grau-transparent

luminaire en suspension; acier, noir, laiton / verre vaporisé, noir gris transparent

H 1100, Ø 190



E27

1x 40W



9 002759 996161

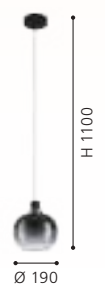





**99617**

**99617 OILELLA**

pendant light; steel, black, brass / glass vaporized, black-grey-transparent

Hängeleuchte; Stahl, schwarz, messing / Glas bedampft, schwarz-grau-transparent

luminaire en suspension; acier, noir, laiton / verre vaporisé, noir gris transparent

L 950, B 190, H 1100



E27



3x 40W



9 002759 996178

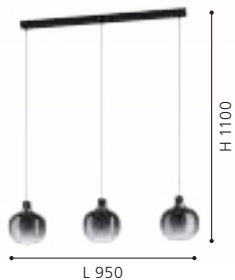

DESIGN  
HIGHLIGHT  
DETAIL



900196



900195



99314



99314

### 900196 AGUILARES

pendant light; steel, black / glass vaporized, black-grey-transparent

Hängeleuchte; Stahl, schwarz / Glas bedampft, schwarz-grau-transparent

luminaire en suspension; acier, noir / verre vaporisé, noir gris transparent

H 1100, Ø 430



E27 3x 40W



9 008606 235568

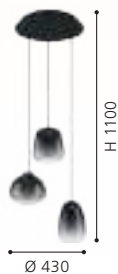

Ø 430

### 900195 AGUILARES

pendant light; steel, black / glass vaporized, black-grey-transparent

Hängeleuchte; Stahl, schwarz / Glas bedampft, schwarz-grau-transparent

luminaire en suspension; acier, noir / verre vaporisé, noir transparent

L 840, B 195, H 1045



E27 3x 40W



9 008606 235551



L 840

### 99314 LEBALIO

pendant light; steel, bronzed / glass vaporized, black-transparent

Hängeleuchte; Stahl, brüniert / Glas bedampft, schwarz-transparent

luminaire en suspension; acier, brun / verre vaporisé, noir transparent

L 1125, B 195, H 1100



E27 3x 40W



9 002759 993146

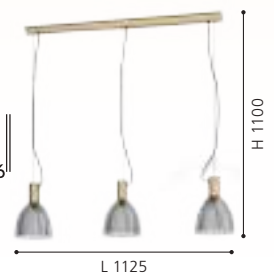

L 1125



### 900549 MARYVILLA

pendant light; steel, black, bronzed / glass vaporized, clear, gold  
 Hängeleuchte; Stahl, schwarz, brüniert / Glas bedampft, klar, gold  
 luminaire en suspension; acier, noir, brun / verre vaporisé, transparent, or

H 1100, Ø 170



### 900551 MARYVILLA

pendant light; steel, black, bronzed / glass vaporized, clear, gold  
 Hängeleuchte; Stahl, schwarz, brüniert / Glas bedampft, klar, gold  
 luminaire en suspension; acier, noir, brun / verre vaporisé, transparent, or

L 870, B 170, H 1100

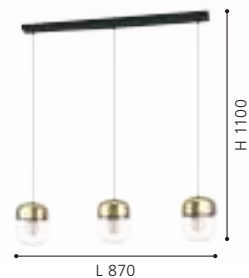



900506



900507



900508



900506 | 900507 | 900508

### 900506 ALOBRASE

pendant light; steel, black, brushed brass / satin glass, grey matt  
Hängeleuchte; Stahl, schwarz, messing-gebürstet / Glas satiniert, grau matt  
luminaire en suspension; acier, noir, laiton brossé / verre satiné, gris mat

H 1100, Ø 200



E27 1x 40W



9 008606 244362

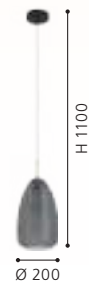

### 900507 BATISTA

pendant light; steel, black, brushed brass / satin glass, grey matt  
Hängeleuchte; Stahl, schwarz, messing-gebürstet / Glas satiniert, grau matt  
luminaire en suspension; acier, noir, laiton brossé / verre satiné, gris mat

H 1100, Ø 120



E27 1x 40W



9 008606 244379



### 900508 BATISTA

pendant light; steel, black, brushed brass / satin glass, grey matt  
Hängeleuchte; Stahl, schwarz, messing-gebürstet / Glas satiniert, grau matt  
luminaire en suspension; acier, noir, laiton brossé / verre satiné, gris mat

L 945, B 120, H 1100



E27 4x 40W



9 008606 244386

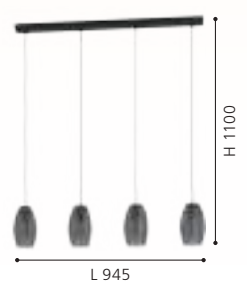



**900813**

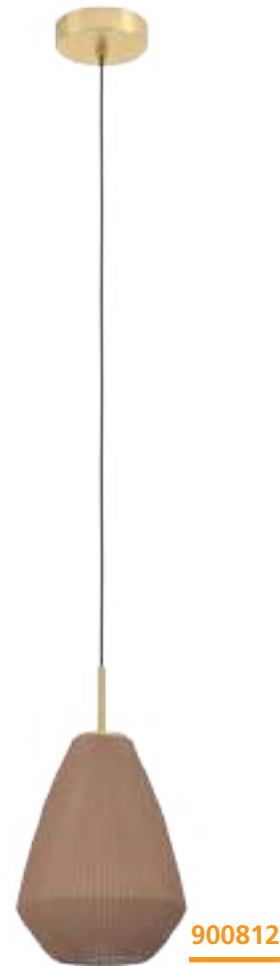

**900812**

### CAPRAROLA, COMINIO

The shade colours of these luminaires look very different when switched on and off.

Die Schirmfarben dieser Leuchten sehen im ein- und ausgeschalteten Zustand sehr unterschiedlich aus.

Les couleurs de la teinte de ces luminaires sont très différentes lorsqu'ils sont allumés et éteints.



### 900813 CAPRAROLA

pendant light; steel, brushed brass / satin glass, sandy

Hängeleuchte; Stahl, messing-gebürstet / Glas satiniert, sandfarben

luminaire en suspension; acier, laiton brossé / verre satiné, couleur sable

L 900, B 200, H 1100



E27



3x 40W



9 008606 274338



### 900812 CAPRAROLA

pendant light; steel, brushed brass / satin glass, sandy

Hängeleuchte; Stahl, messing-gebürstet / Glas satiniert, sandfarben

luminaire en suspension; acier, laiton brossé / verre satiné, couleur sable

H 1100, Ø 200



E27



1x 40W



9 008606 274321





**900893**



**900894**

### 900893 COMINIO

pendant light; steel, taupe / etched glass, sandy  
 Hängeleuchte; Stahl, taupe / Glas geätzt, sandfarben  
 luminaire en suspension; acier, taupe / verre gravé, couleur sable

H 1100, Ø 185



E27 1x 40W



9 008606 274581



### 900894 COMINIO

pendant light; steel, taupe / etched glass, sandy  
 Hängeleuchte; Stahl, taupe / Glas geätzt, sandfarben  
 luminaire en suspension; acier, taupe / verre gravé, couleur sable

L 885, B 185, H 1100



E27 3x 40W



9 008606 274598

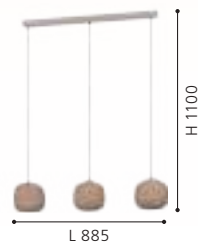



98614



98616



ALOBRASE

### 98614 ALOBRASE

pendant light; steel, chrome / glass vaporized, black-transparent  
Hängeleuchte; Stahl, chrom / Glas bedampft, schwarz-transparent  
luminaire en suspension; acier, chrome / verre vaporisé, noir transparent

H 1100, Ø 300



### 98616 ALOBRASE

pendant light; steel, chrome / glass vaporized, black-transparent  
Hängeleuchte; Stahl, chrom / Glas bedampft, schwarz-transparent  
luminaire en suspension; acier, chrome / verre vaporisé, noir transparent

L 1080, B 150, H 1100



### 98615 ALOBRASE

pendant light; steel, chrome / glass vaporized, black-transparent  
Hängeleuchte; Stahl, chrom / Glas bedampft, schwarz-transparent  
luminaire en suspension; acier, chrome / verre vaporisé, noir transparent

H 1100, Ø 200

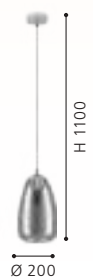





98615

### 98617 ALOBRASE

pendant light; steel, chrome / glass vaporized, black-transparent  
Hängeleuchte; Stahl, chrom / Glas bedampft, schwarz-transparent  
luminaire en suspension; acier, chrome / verre vaporisé, noir transparent

H 1500, Ø 540



E27



5x 40W



9 002759 986179

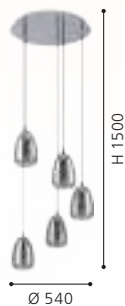

98617



**98647**

### 98647 ALOBRASE

pendant light; steel, brushed brass / glass vaporized, amber  
 Hängeleuchte; Stahl, messing-gebürstet / Glas bedampft, ambre  
 luminaire en suspension; acier, laiton brossé / verre vaporisé, ambre

H 1100, Ø 300



9 002759 986476



**98649**

### 98649 ALOBRASE

pendant light; steel, brushed brass / glass vaporized, amber  
 Hängeleuchte; Stahl, messing-gebürstet / Glas bedampft, ambre  
 luminaire en suspension; acier, laiton brossé / verre vaporisé, ambre

L 1080, B 150, H 1100



9 002759 986490





ALOBRASE

98648

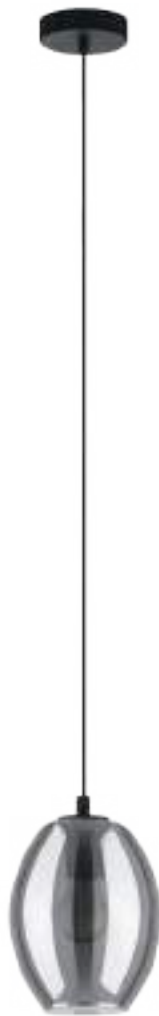

98582 | 98585

98582



98585

### 98648 ALOBRASE

pendant light; steel, brushed brass / glass vaporized, amber  
Hängeleuchte; Stahl, messing-gebürstet / Glas bedampft, amber  
luminaire en suspension; acier, laiton brossé / verre vaporisé, ambre

H 1100, Ø 200



E27 1x 40W



9 002759 986483



### 98582 CADAQUES

pendant light; steel, black / smoked glass, black-transparent  
Hängeleuchte; Stahl, schwarz / Rauchglas, schwarz-transparent  
luminaire en suspension; acier, noir / verre fumé, noir transparent

H 1100, Ø 180



E27 1x 40W



9 002759 985820



### 98585 CADAQUES 1

pendant light; steel, black / smoked glass, black-transparent  
Hängeleuchte; Stahl, schwarz / Rauchglas, schwarz-transparent  
luminaire en suspension; acier, noir / verre fumé, noir transparent

H 1100, Ø 160



E27 1x 40W



9 002759 985851





ARISCANI



**98651**

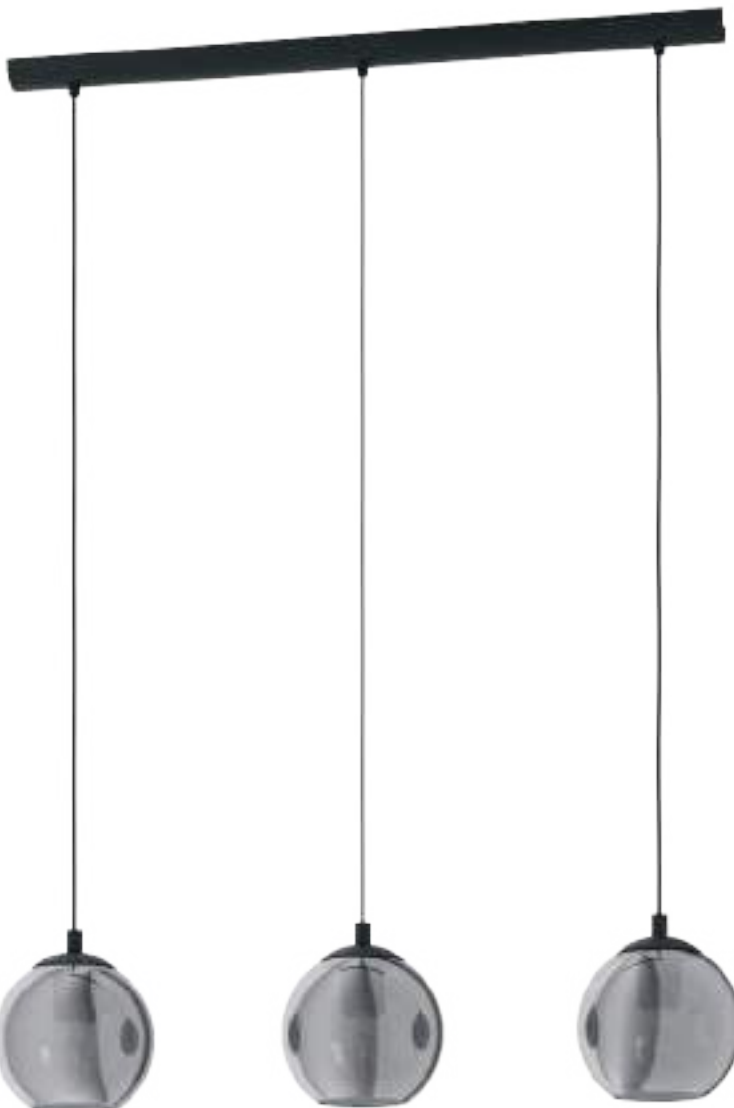

**98652**

### 98651 ARISCANI

pendant light; steel, black / glass vaporized, black-transparent  
Hängeleuchte; Stahl, schwarz / Glas bedampft, schwarz-transparent  
luminaire en suspension; acier, noir / verre vaporisé, noir transparent

H 1100, Ø 200



### 98652 ARISCANI

pendant light; steel, black / glass vaporized, black-transparent  
Hängeleuchte; Stahl, schwarz / Glas bedampft, schwarz-transparent  
luminaire en suspension; acier, noir / verre vaporisé, noir transparent

L 765, B 165, H 1100





**98653**



**98654**

### 98653 ARISCANI

pendant light; steel, black / glass vaporized, black-transparent  
 Hängeleuchte; Stahl, schwarz / Glas bedampft, schwarz-transparent  
 luminaire en suspension; acier, noir / verre vaporisé, noir transparent

H 1100, Ø 425



9 002759 986537



### 98654 ARISCANI

pendant light; steel, black / glass vaporized, black-transparent  
 Hängeleuchte; Stahl, schwarz / Glas bedampft, schwarz-transparent  
 luminaire en suspension; acier, noir / verre vaporisé, noir transparent

H 1700, Ø 655



9 002759 986544





**96774**



**96773**



MURMILLO

**96774 MURMILLO**

pendant light; steel, chrome / smoked glass, black-transparent  
 Hängeleuchte; Stahl, chrom / Rauchglas, schwarz-transparent  
 luminaire en suspension; acier, chrome / verre fumé, noir transparent

L 770, B 170, H 1500



E27



3x 28W



9 002759 967741



**96773 MURMILLO**

pendant light; steel, chrome / smoked glass, black-transparent  
 Hängeleuchte; Stahl, chrom / Rauchglas, schwarz-transparent  
 luminaire en suspension; acier, chrome / verre fumé, noir transparent

H 1500, Ø 170



E27



1x 28W



9 002759 967734





96343

LED

96344

LED

96345

LED

### 96343 FARSALA

pendant light; steel, satin nickel / smoked glass, granules, black-transparent, clear

Hängeleuchte; Stahl, nickel-matt / Rauchglas, Granille, schwarz-transparent, klar

luminaire en suspension; acier, nickel mat / verre fumé, granité, noir transparent, transparent

H 1100, Ø 125



G9



1x 3W



1x

320lm



9 002759 963439



### 96344 FARSALA

pendant light; steel, satin nickel / smoked glass, granules, black-transparent, clear

Hängeleuchte; Stahl, nickel-matt / Rauchglas, Granille, schwarz-transparent, klar

luminaire en suspension; acier, nickel mat / verre fumé, granité, noir transparent, transparent

L 975, B 100, H 1100



G9



4x 3W



4x

320lm

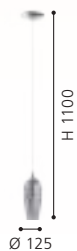

Ø 125



9 002759 963446

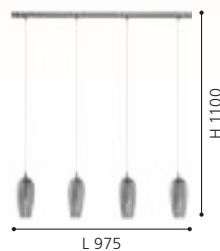

L 975

### 96345 FARSALA

pendant light; steel, satin nickel / smoked glass, granules, black-transparent, clear

Hängeleuchte; Stahl, nickel-matt / Rauchglas, Granille, schwarz-transparent, klar

luminaire en suspension; acier, nickel mat / verre fumé, granité, noir transparent, transparent

H 1500, Ø 350



G9



5x 3W



5x

320lm



9 002759 963453



Ø 350



99371





98384 | 99371



98384

### 99371 MANTUNALLE 1

pendant light; steel, black / glass vaporized, black-transparent  
 Hängeleuchte; Stahl, schwarz / Glas bedampft, schwarz-transparent  
 luminaire en suspension; acier, noir / verre vaporisé, noir transparent

H 1100, Ø 200



### 98384 BELESER

pendant light; steel, black / glass vaporized, black-transparent  
 Hängeleuchte; Stahl, schwarz / Glas bedampft, schwarz-transparent  
 luminaire en suspension; acier, noir / verre vaporisé, noir transparent

L 905, B 205, H 1100

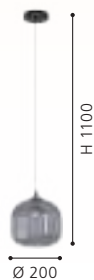

DESIGN  
HIGHLIGHT  
DETAIL



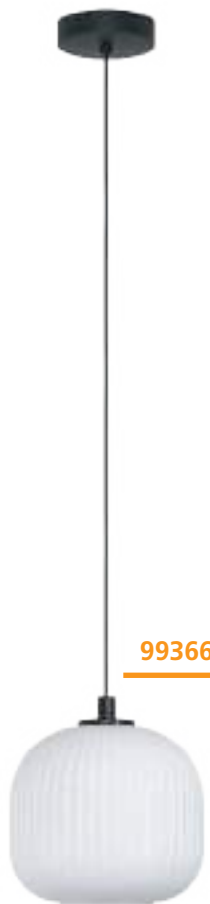

99366



99367 | 99368

### 99366 MANTUNALLE

pendant light; steel, black / glass, white  
 Hängeleuchte; Stahl, schwarz / Glas, weiss  
 luminaire en suspension; acier, noir / verre, blanc

H 1100, Ø 200



### 99368 MANTUNALLE

pendant light; steel, black / glass, white  
 Hängeleuchte; Stahl, schwarz / Glas, weiss  
 luminaire en suspension; acier, noir / verre, blanc

H 1100, Ø 620



### 99367 MANTUNALLE

pendant light; steel, black / glass, white  
 Hängeleuchte; Stahl, schwarz / Glas, weiss  
 luminaire en suspension; acier, noir / verre, blanc

L 1200, B 200, H 1100

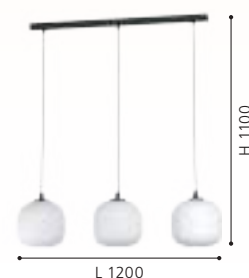

99367





98696



98697



98694



98694 | 98695

### 98696 SELVINO

pendant light; steel, satin nickel / glass vaporized, gold-coloured, brown

Hängeleuchte; Stahl, nickel-matt / Glas bedampft, goldfarben  
luminaire en suspension; acier, nickel mat / verre vaporisé, couleur or

H 1100, Ø 100



E27 1x 15W



9 002759 986964



### 98697 SELVINO

pendant light; steel, satin nickel / glass vaporized, gold-coloured, brown

Hängeleuchte; Stahl, nickel-matt / Glas bedampft, goldfarben  
luminaire en suspension; acier, nickel mat / verre vaporisé, couleur or

L 710, B 100, H 1100



E27 3x 15W



9 002759 986971

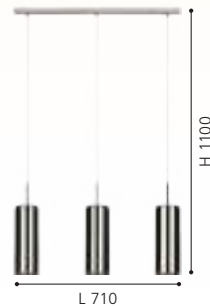

### 98694 SELVINO

pendant light; steel, satin nickel / glass vaporized, black-transparent

Hängeleuchte; Stahl, nickel-matt / Glas bedampft, schwarz-transparent  
luminaire en suspension; acier, nickel mat / verre vaporisé, noir transparent

H 1100, Ø 100



E27 1x 15W



9 002759 986940





98696 | 98697 | 98698 |  
98699

### 98695 SELVINO

pendant light; steel, satin nickel / glass vaporized, black-transparent

Hängeleuchte; Stahl, nickel-matt / Glas bedampft, schwarz-transparent

luminaire en suspension; acier, nickel mat / verre vaporisé, noir transparent

L 710, B 100, H 1100



E27 3x 15W



9 002759 986957

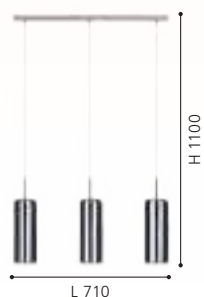

### 98698 SELVINO

pendant light; steel, satin nickel / glass vaporized, copper-coloured

Hängeleuchte; Stahl, nickel-matt / Glas bedampft, kupferfarben

luminaire en suspension; acier, nickel mat / verre vaporisé, cuivré

H 1100, Ø 100



E27 1x 15W



9 002759 986988

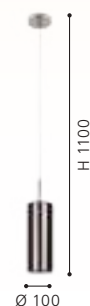

### 98699 SELVINO

pendant light; steel, satin nickel / glass vaporized, copper-coloured

Hängeleuchte; Stahl, nickel-matt / Glas bedampft, kupferfarben

luminaire en suspension; acier, nickel mat / verre vaporisé, cuivré

L 710, B 100, H 1100



E27 3x 15W



9 002759 986995



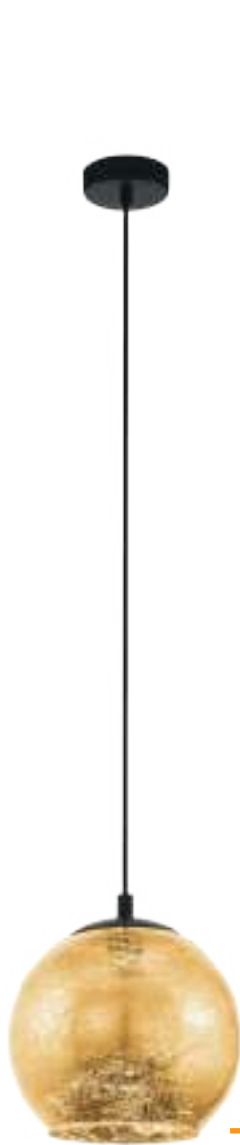

**98523**



**98524**



**98526**

### 98523 ALBARACCIN

pendant light; steel, black / glass, gold-coloured, brown  
Hängeleuchte; Stahl, schwarz / Glas, goldfarben  
luminaire en suspension; acier, noir / verre, couleur or

H 1100, Ø 270



9 002759 985233

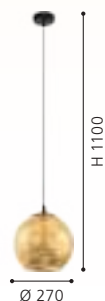

### 98524 ALBARACCIN

pendant light; steel, black / glass, gold-coloured, brown  
Hängeleuchte; Stahl, schwarz / Glas, goldfarben  
luminaire en suspension; acier, noir / verre, couleur or

H 1100, Ø 190



9 002759 985240



### 98526 ALBARACCIN

pendant light; steel, black / glass, gold-coloured, brown  
Hängeleuchte; Stahl, schwarz / Glas, goldfarben  
luminaire en suspension; acier, noir / verre, couleur or

H 1500, Ø 585



9 002759 985264





**98525**

### 98525 ALBARACCIN

pendant light; steel, black / glass, gold-coloured, brown  
Hängeleuchte; Stahl, schwarz / Glas, goldfarben  
luminaire en suspension; acier, noir / verre, couleur or

L 780, B 190, H 1100



E27



3x 40W



9 002759 985257





99654

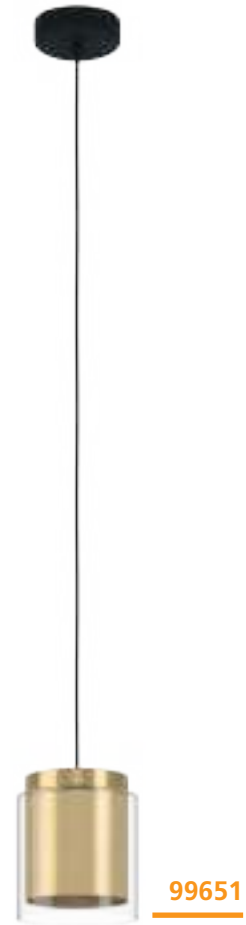

99651

### 99654 LAGUNITAS

pendant light; steel, black, brass, gold / glass, clear  
 Hängeleuchte; Stahl, schwarz, messing, gold / Glas, klar  
 luminaire en suspension; acier, noir, laiton, or / verre, transparent

L 910, B 150, H 1100



### 99651 LAGUNITAS

pendant light; steel, black, brass, gold / glass, clear  
 Hängeleuchte; Stahl, schwarz, messing, gold / Glas, klar  
 luminaire en suspension; acier, noir, laiton, or / verre, transparent

H 1100, Ø 150







99628

LED



99629

LED



### 99628 CERASELLA

pendant light; steel, brushed brass / glass, clear  
Hängeleuchte; Stahl, messing-gebürstet / Glas, klar  
luminaire en suspension; acier, laiton brossé / verre, transparent

H 1100, Ø 200



GU10



1x 4,5W



1x

345lm



9 002759 996284



INCL.



### 99629 CERASELLA

pendant light; steel, brushed brass / glass, clear  
Hängeleuchte; Stahl, messing-gebürstet / Glas, klar  
luminaire en suspension; acier, laiton brossé / verre, transparent

L 900, B 200, H 1100



GU10



3x 4,5W



3x

345lm



9 002759 996291



INCL.



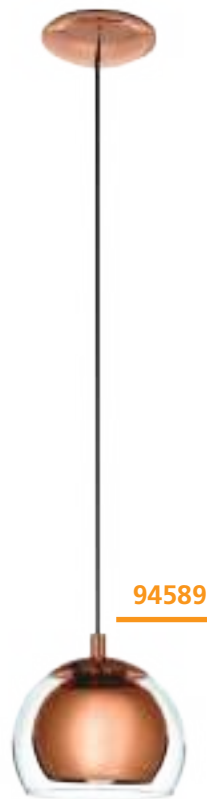

94589

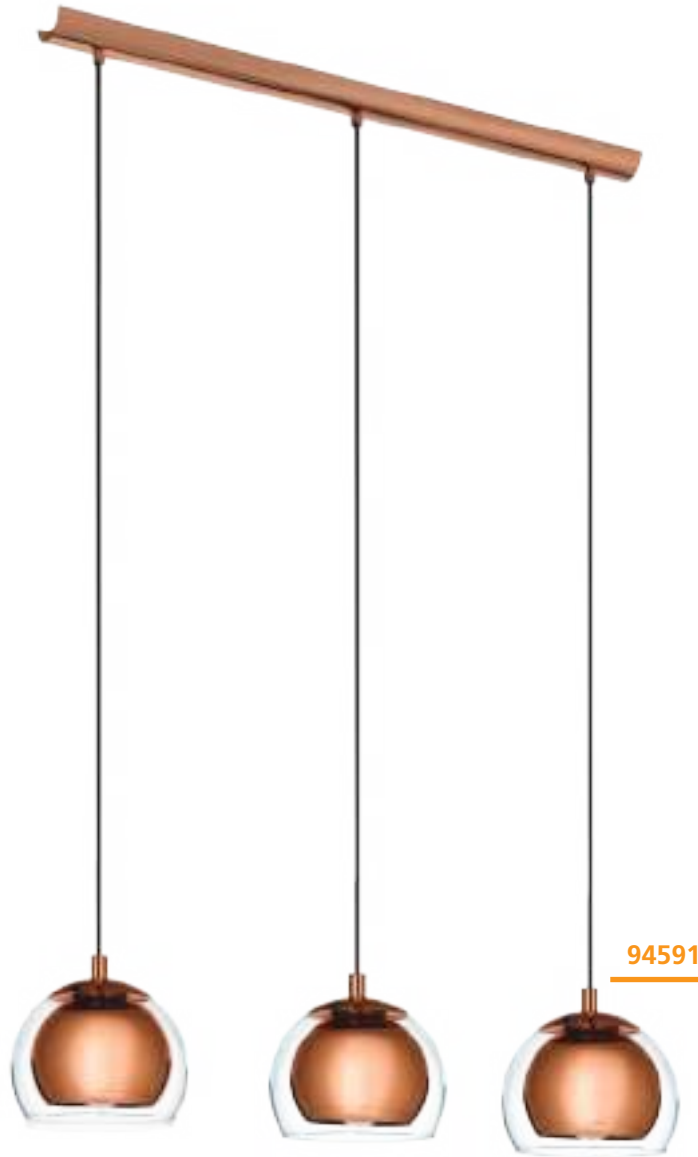

94591

DESIGN  
HIGHLIGHT  
DETAIL

### 94589 ROCAMAR

pendant light; steel, copper / glass, clear  
Hängeleuchte; Stahl, kupfer / Glas, klar  
luminaire en suspension; acier, cuivre / verre, transparent

H 1100, Ø 190



9 002759 945893



### 94591 ROCAMAR

pendant light; steel, copper / glass, clear  
Hängeleuchte; Stahl, kupfer / Glas, klar  
luminaire en suspension; acier, cuivre / verre, transparent

L 780, B 190, H 1100



9 002759 945916

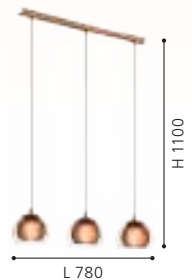



98595



93836

### 98595 ROCAMAR 1

pendant light; steel, copper / glass, clear  
 Hängeleuchte; Stahl, kupfer / Glas, klar  
 luminaire en suspension; acier, cuivre / verre, transparent

H 1500, Ø 585



E27 5x 28W



9 002759 985950

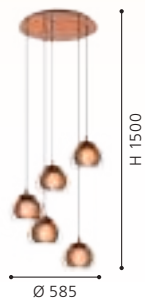

### 93836 CORETTO

pendant light; steel, brushed copper  
 Hängeleuchte; Stahl, kupfer-gebürstet  
 luminaire en suspension; acier, cuivre brossé

H 1100, Ø 170



E27 1x 60W



9 002759 938369



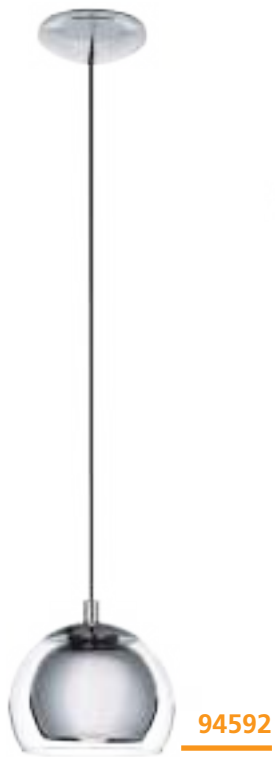

### 94592 ROCAMAR

pendant light; steel, chrome / glass, clear  
 Hängeleuchte; Stahl, chrom / Glas, klar  
 luminaire en suspension; acier, chrome / verre, transparent

H 1100, Ø 190



9 002759 945923



### 94593 ROCAMAR

pendant light; steel, chrome / glass, clear  
 Hängeleuchte; Stahl, chrom / Glas, klar  
 luminaire en suspension; acier, chrome / verre, transparent

L 780, B 190, H 1100



9 002759 945930



### 98596 ROCAMAR 1

pendant light; steel, chrome / glass, clear  
 Hängeleuchte; Stahl, chrom / Glas, klar  
 luminaire en suspension; acier, chrome / verre, transparent

H 1500, Ø 585



9 002759 985967

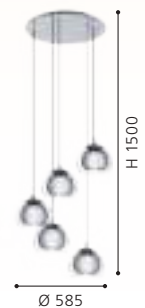



94378



94377



LONGINO 1

### 94378 LONGINO 1

pendant light; steel, chrome / glass, satin glass, clear, white  
 Hängeleuchte; Stahl, chrom / Glas, Glas satiniert, klar, weiss  
 luminaire en suspension; acier, chrome / verre, verre satiné,  
 transparent, blanc

L 745, B 150, H 1100



9 002759 943783



### 94377 LONGINO 1

pendant light; steel, chrome / glass, satin glass, clear, white  
 Hängeleuchte; Stahl, chrom / Glas, Glas satiniert, klar, weiss  
 luminaire en suspension; acier, chrome / verre, verre satiné,  
 transparent, blanc

L 150, B 150, H 1100



9 002759 943776





96528

LED

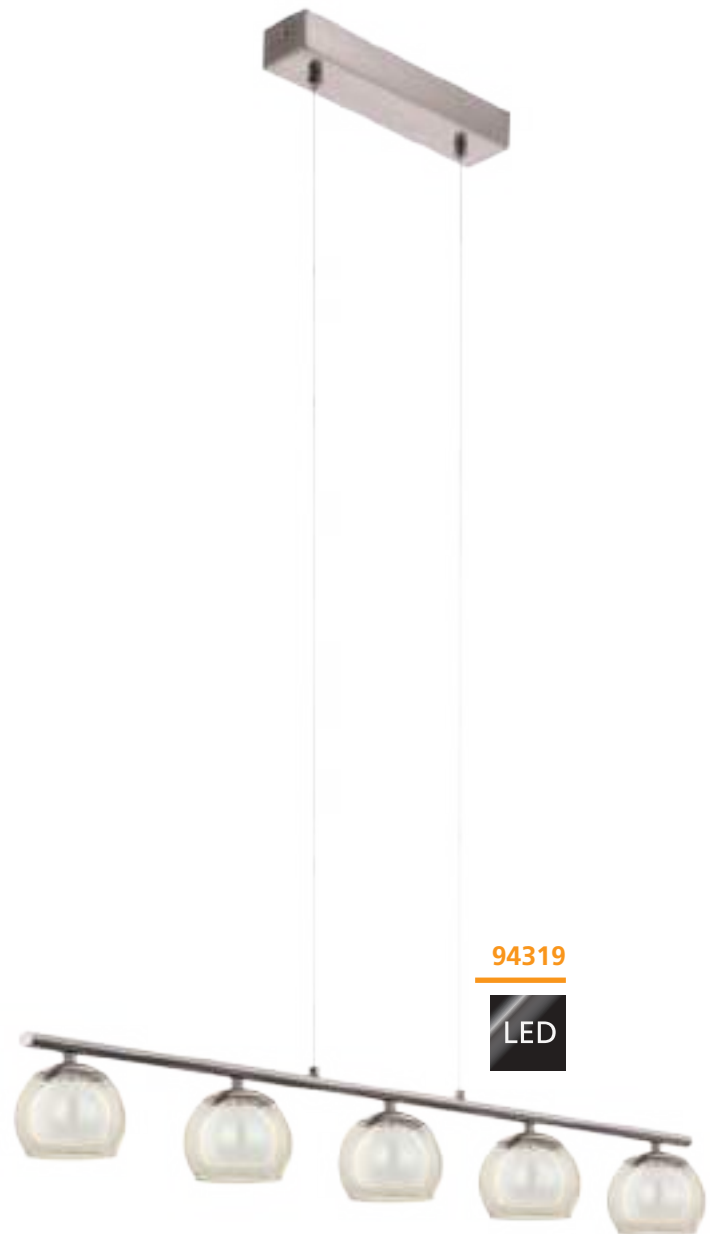

94319

LED

### 96528 ALEANDRO 1

pendant light; steel, chrome / matte-opal glass, white  
 Hängeleuchte; Stahl, chrom / Glas opal-matt, weiss  
 luminaire en suspension; acier, chrome / verre opale mat, blanc

L 800, B 120, H 860 - 1550



4x 4,5W 2000lm



9 002759 965280

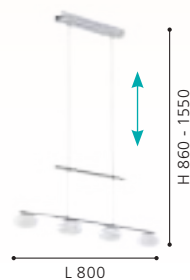

### 94319 ROMAGNESE

pendant light; steel, satin nickel / glass, satin glass, amber, white  
 Hängeleuchte; Stahl, nickel-matt / Glas, Glas satiniert, ambre, weiss  
 luminaire en suspension; acier, nickel mat / verre, verre satiné, ambre, blanc

L 900, B 105, H 1100



5x 3,3W 1700lm



9 002759 943196





97793



97587

**97793 VALLASPRA**

pendant light; steel, champagne / matte-opal glass, white  
Hängeleuchte; Stahl, champagner / Glas opal-matt, weiss  
luminaire en suspension; acier, champagne / verre opale mat, blanc

L 910, B 165, H 1100

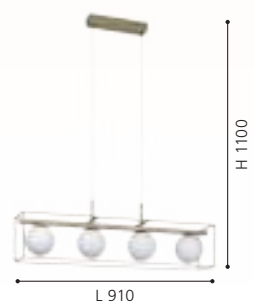
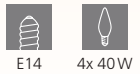

**97587 BATISTA 3**

pendant light; steel, satin nickel / glass wiping technique, white  
Hängeleuchte; Stahl, nickel-matt / Glas Wischtechnik, weiss  
luminaire en suspension; acier, nickel mat / technique de verre essuyé, blanc

L 1020, B 120, H 1100

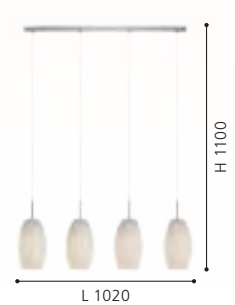



**92762**



**92761**

### 92762 BOLSANO

pendant light; steel, chrome / satin glass, glass, white, clear  
 Hängeleuchte; Stahl, chrom / Glas satiniert, Glas, weiss, klar  
 luminaire en suspension; acier, chrome / verre satiné, verre, blanc, transparent

H 1300, Ø 505



E27 3x 60W



9 002759 927622



### 92761 BOLSANO

pendant light; steel, chrome / satin glass, glass, white, clear  
 Hängeleuchte; Stahl, chrom / Glas satiniert, Glas, weiss, klar  
 luminaire en suspension; acier, chrome / verre satiné, verre, blanc, transparent

H 1300, Ø 200



E27 1x 60W



9 002759 927615







EGLO  
RECOMMENDS  
**110003**  
CLEMENTE

**95286**



**95287**

### 95286 CLEMENTE

pendant light; steel, chrome / brilliant glass, clear  
Hängeleuchte; Stahl, chrom / Brillantglas, klar  
luminaire en suspension; acier, chrome / verre brillant, transparent

H 1100, Ø 350



9 002759 952860



### 95287 CLEMENTE

pendant light; steel, chrome / brilliant glass, clear  
Hängeleuchte; Stahl, chrom / Brillantglas, klar  
luminaire en suspension; acier, chrome / verre brillant, transparent

H 1100, Ø 540



9 002759 952877





93625

LED

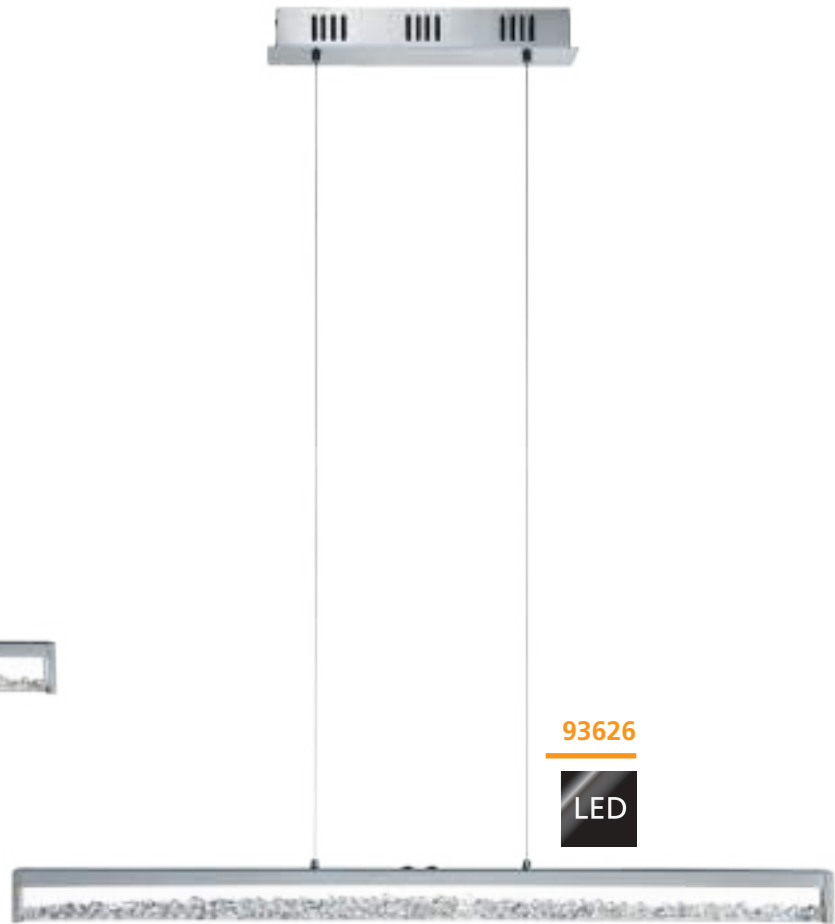

93626

LED



TOUCH ME



see the tunable white video  
 unser Tunable White Video  
 notre video de blanc réglable

## CARDITO 1



Warm White 2700K Neutral White Cold White 5000K

These luminaires can be switched on and off by touching the specially designed "Touch Me" part of the fixture. Features via touch-dimmer:

- > light colour adjustable between 2700K - 5000K
- > dimmable 10% - 100%

Diese Leuchten können ein und ausgeschaltet werden, indem man sie an den dafür vorgesehenen „Touch Me“ Bereichen berührt. Per Touch-Dimmer verfügen diese Leuchten über folgende Funktionen:

- > Lichtfarbe einstellbar im Bereich 2700K bis 5000K
- > dimmbar 10% bis 100%

Ces luminaires peuvent être éteints et allumés simplement en touchant la partie spécialement conçue pour «Touch Me» du luminaire. Fonctions du gradateur «touch»:

- > couleur lumineuse réglable de 2700K - 5000K
- > réglable en luminosité 10% - 100%

## 93625 CARDITO 1

pendant light; aluminium, steel, chrome / glass, brilliant glass, clear

Hängeleuchte; Alu, Stahl, chrom / Glas, Brillantglas, klar

luminaire en suspension; aluminium, acier, chrome / verre, verre brillant, transparent

L 700, B 80, H 750 - 1300



4x 6W



2280lm



9 002759 936259

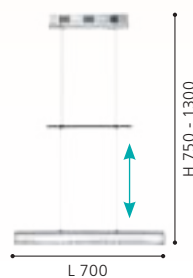

## 93626 CARDITO 1

pendant light; aluminium, steel, chrome / glass, brilliant glass, clear

Hängeleuchte; Alu, Stahl, chrom / Glas, Brillantglas, klar

luminaire en suspension; aluminium, acier, chrome / verre, verre brillant, transparent

L 1000, B 80, H 1100



6x 6W



3420lm



9 002759 936266

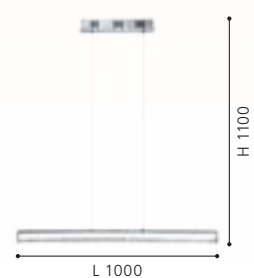

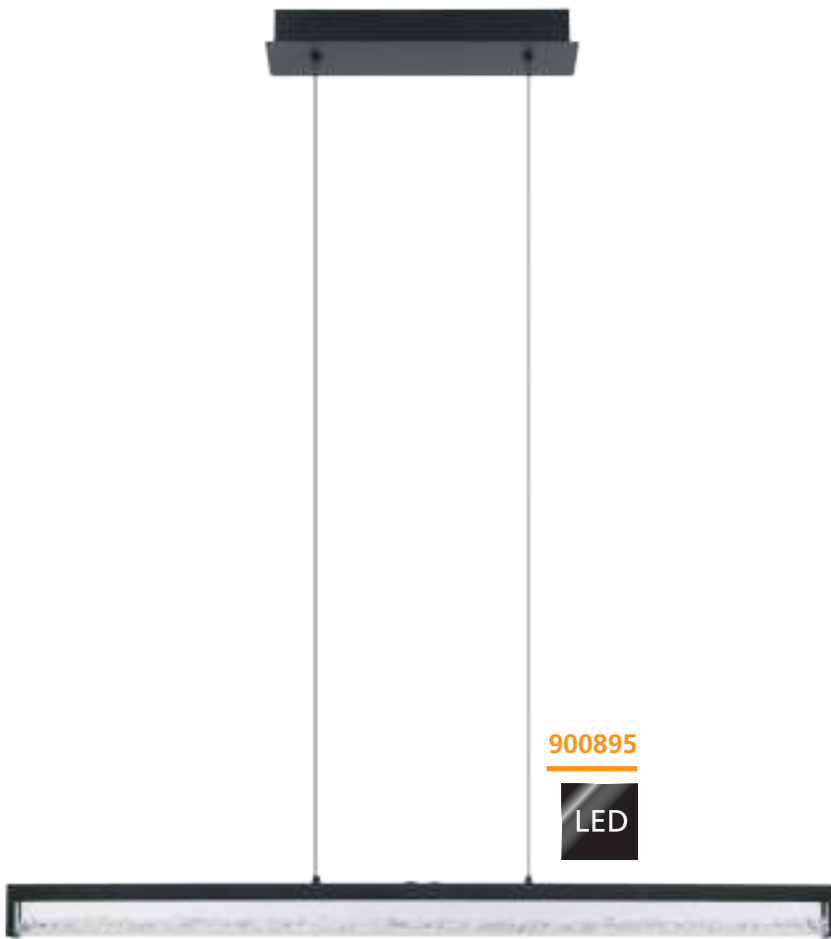

900895



31667



### 900895 CARDITO 1

pendant light; aluminium, steel, black / glass, brilliant glass, clear  
 Hängeleuchte; Alu, Stahl, schwarz / Glas, Brillantglas, klar  
 luminaire en suspension; aluminium, acier, noir / verre, verre  
 brillant, transparent

L 1000, B 80, H 1100



6x 6W 3420lm



9 008606 267941

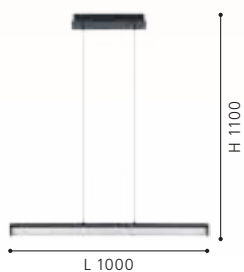

### 31667 VARRAZO

pendant light; steel, chrome / brilliant glass, clear  
 Hängeleuchte; Stahl, chrom / Brillantglas, klar  
 luminaire en suspension; acier, chrome / verre brillant, trans-  
 parent

H 1200, Ø 550



29W 4300lm



9 002759 316679

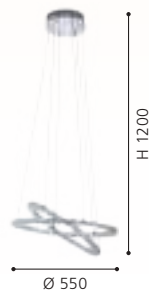

## MONTEFIO 1

These luminaires come with high quality brilliant glass.

Diese Leuchten sind mit hochwertigem Brillantglas ausgestattet.

Ces lumières sont fabriquées avec une haute qualité Equipé de verre brillant.



93073



93709



### 93073 LUBERIO

pendant light; steel, chrome / glass, aluminium, clear, aluminium  
Hängeleuchte; Stahl, chrom / Glas, Alu, klar, alu  
luminaire en suspension; acier, chrome / verre, aluminium, transparent, aluminium

H 1100, Ø 250



E27



1x 60W



9 002759 930738



### 93709 MONTEFIO 1

pendant light; steel, chrome / glass, brilliant glass, white, clear  
Hängeleuchte; Stahl, chrom / Glas, Brillantglas, weiss, klar  
luminaire en suspension; acier, chrome / verre, verre brillant, blanc, transparent

H 1100, Ø 400



3x 5W



warm WHITE  
1500lm



9 002759 937096

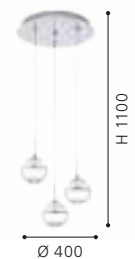



93708

LED



93784

LED

### 93708 MONTEFIO 1

pendant light; steel, chrome / glass, brilliant glass, white, clear  
 Hängeleuchte; Stahl, chrom / Glas, Brillantglas, weiss, klar  
 luminaire en suspension; acier, chrome / verre, verre brillant,  
 blanc, transparent

H 1100, Ø 140



1x 5W 480lm



9 002759 937089



### 93784 MONTEFIO 1

pendant light; steel, chrome / glass, brilliant glass, white, clear  
 Hängeleuchte; Stahl, chrom / Glas, Brillantglas, weiss, klar  
 luminaire en suspension; acier, chrome / verre, verre brillant,  
 blanc, transparent

L 870, B 140, H 1100



3x 5W 1500lm



9 002759 937843





98628



98629



MIOGLIA 1

### 98628 MIOGLIA 1

pendant light; steel, chrome / plastic, white granules, clear  
 Hängeleuchte; Stahl, chrom / Kunststoff, granille weiss, klar  
 luminaire en suspension; acier, chrome / plastique, blanc granille, transparent

L 975, B 150, H 1100



E14



4x 25W



9 002759 986285

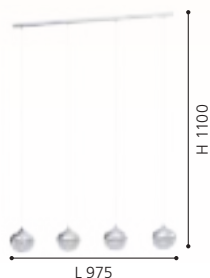

L 975

H 1100

### 98629 MIOGLIA 1

pendant light; steel, chrome / plastic, white granules, clear  
 Hängeleuchte; Stahl, chrom / Kunststoff, granille weiss, klar  
 luminaire en suspension; acier, chrome / plastique, blanc granille, transparent

H 1500, Ø 540



E14



5x 25W



9 002759 986292



Ø 540

H 1500

### 95913 CONESSA

pendant light; steel, chrome / plastic, clear  
 Hängeleuchte; Stahl, chrom / Kunststoff, klar  
 luminaire en suspension; acier, chrome / plastique, transparent

H 1100, Ø 290



GU10



3x 3W



3x 250lm



9 002759 959135



INCL.

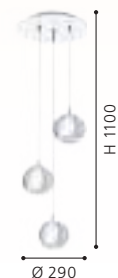

Ø 290

H 1100



95913

LED

95912

LED



95914

LED

### 95912 CONESSA

pendant light; steel, chrome / plastic, clear  
 Hängeleuchte; Stahl, chrom / Kunststoff, klar  
 luminaire en suspension; acier, chrome / plastique, transparent

L 1010, B 150, H 1100

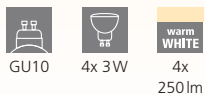

9 002759 959128

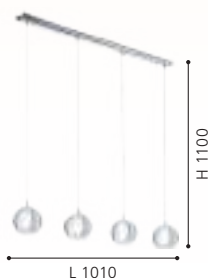

### 95914 CONESSA

pendant light; steel, chrome / plastic, clear  
 Hängeleuchte; Stahl, chrom / Kunststoff, klar  
 luminaire en suspension; acier, chrome / plastique, transparent

H 1700, Ø 580



9 002759 959142

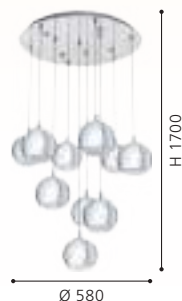



94244

LED



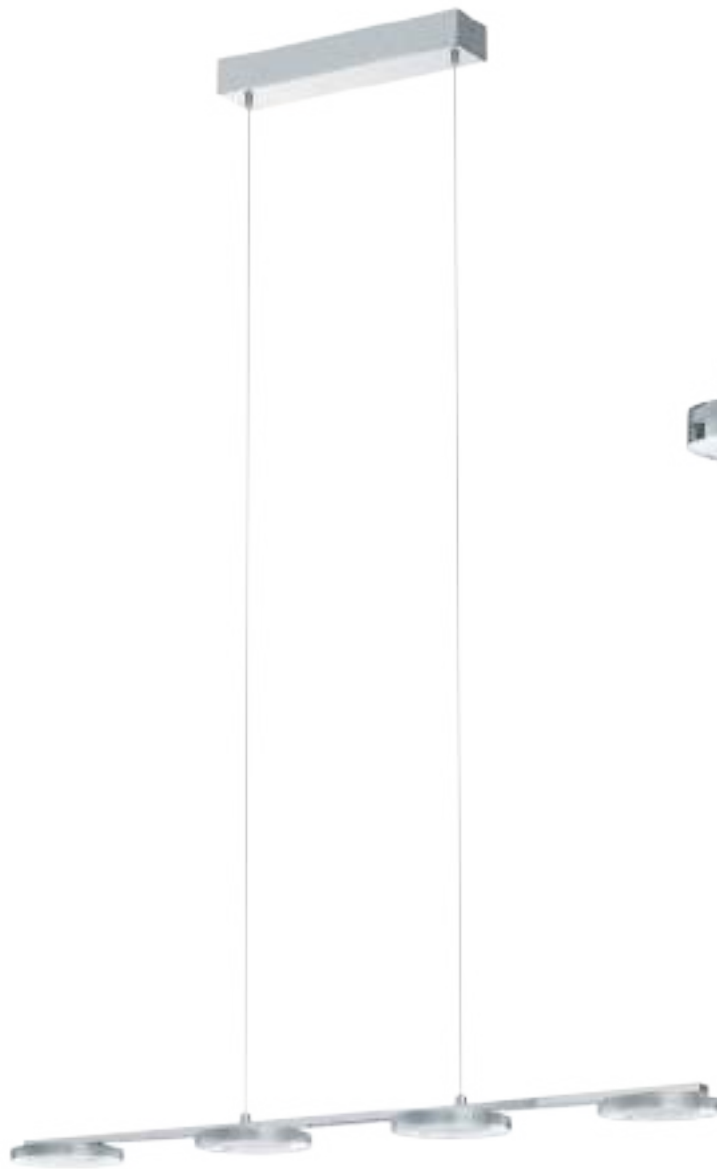

DESIGN  
HIGHLIGHT  
DETAIL

94245

LED

### 94244 CARTAMA

pendant light; steel, chrome / plastic, clear, satin finish  
Hängeleuchte; Stahl, chrom / Kunststoff, klar, satiniert  
luminaire en suspension; acier, chrome / plastique, transparent, satiné

L 780, B 90, H 1100



4x 4,6W 2200lm



### 94245 CARTAMA

pendant light; steel, chrome / plastic, clear, satin finish  
Hängeleuchte; Stahl, chrom / Kunststoff, klar, satiniert  
luminaire en suspension; acier, chrome / plastique, transparent, satiné

L 775, B 115, H 1100



4x 4,6W 2200lm

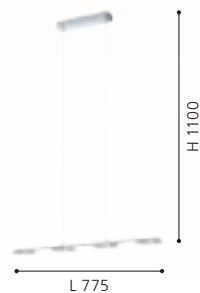



**97366**

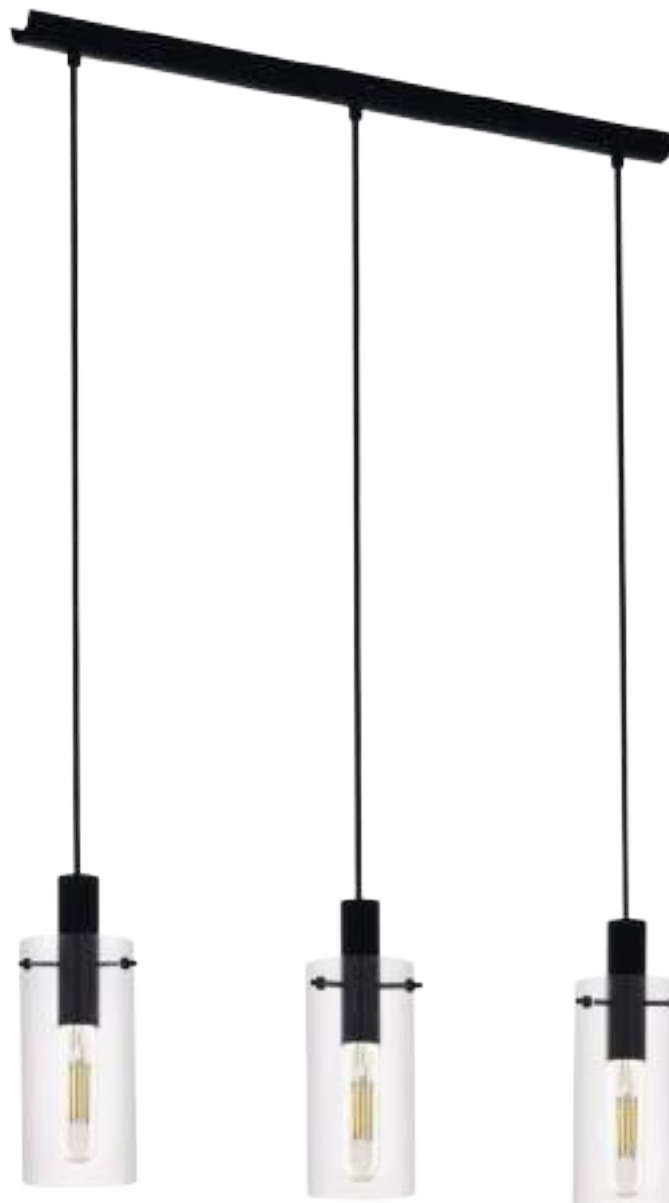

**97367**

### 97366 MONTEFINO

pendant light; steel, black / glass, clear  
 Hängeleuchte; Stahl, schwarz / Glas, klar  
 luminaire en suspension; acier, noir / verre, transparent

H 1100, Ø 110



### 97367 MONTEFINO

pendant light; steel, black / glass, clear  
 Hängeleuchte; Stahl, schwarz / Glas, klar  
 luminaire en suspension; acier, noir / verre, transparent

L 730, B 110, H 1100



### 97368 MONTEFINO

pendant light; steel, black / glass, clear  
 Hängeleuchte; Stahl, schwarz / Glas, klar  
 luminaire en suspension; acier, noir / verre, transparent

H 1500, Ø 350





97368



98056



98058

### 98056 CORTENOVA

pendant light; steel, black  
Hängeleuchte; Stahl, schwarz  
luminaire en suspension; acier, noir

H 1100, Ø 105



9 002759 980566

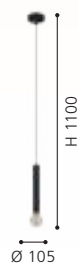

### 98058 CORTENOVA

pendant light; steel, black  
Hängeleuchte; Stahl, schwarz  
luminaire en suspension; acier, noir

H 1500, Ø 350



9 002759 980580



### 98057 CORTENOVA

pendant light; steel, black  
Hängeleuchte; Stahl, schwarz  
luminaire en suspension; acier, noir

L 840, B 60, H 1100



9 002759 980573

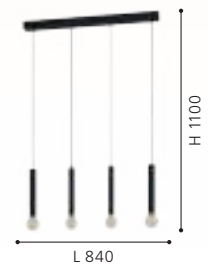



98057



900799



900798



900801



### 900799 POZUETA 1

pendant light; steel, brushed brass  
Hängeleuchte; Stahl, messing-gebürstet  
luminaire en suspension; acier, laiton brossé

H 1100, Ø 65



E27 1x 40W



9 008606 270248

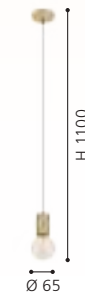

### 900798 POZUETA 1

pendant light; steel, white  
Hängeleuchte; Stahl, weiss  
luminaire en suspension; acier, blanc

H 1100, Ø 65



E27 1x 40W



9 008606 270231

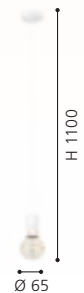

### 900801 POZUETA 1

pendant light; steel, wood, black, brown  
Hängeleuchte; Stahl, Holz, schwarz, braun  
luminaire en suspension; acier, bois, noir, marron

H 1100, Ø 65



E27 1x 40W



9 008606 270255





98661







98663



98662



POZUETA

### 98661 POZUETA

pendant light; steel, black  
Hängeleuchte; Stahl, schwarz  
luminaire en suspension; acier, noir

H 1100, Ø 125



E27 1x 40W



9 002759 986612



### 98663 POZUETA

pendant light; steel, black  
Hängeleuchte; Stahl, schwarz  
luminaire en suspension; acier, noir

H 1500, Ø 330

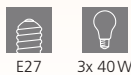

E27 3x 40W



9 002759 986636



### 98662 POZUETA

pendant light; steel, black  
Hängeleuchte; Stahl, schwarz  
luminaire en suspension; acier, noir

L 840, B 65, H 1100



E27 3x 40W



9 002759 986629





**98346**



**98347**

### 98346 BOCADELLA

pendant light; steel, black  
Hängeleuchte; Stahl, schwarz  
luminaire en suspension; acier, noir

H 1100, Ø 640



E27

9x 60W



9 002759 983468

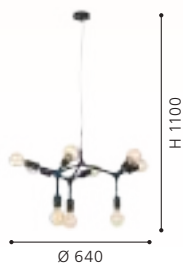

### 98347 BOCADELLA

pendant light; steel, black  
Hängeleuchte; Stahl, schwarz  
luminaire en suspension; acier, noir

H 1100, Ø 920



E27

12x 60W



9 002759 983475

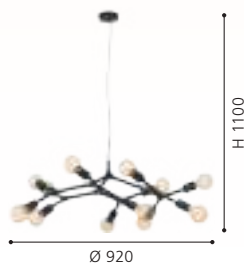

### 98909 MEZZANA

pendant light; steel, black  
Hängeleuchte; Stahl, schwarz  
luminaire en suspension; acier, noir

L 650, B 650, H 1100



E27

8x 40W



9 002759 989095





98909



98017



98016

99811

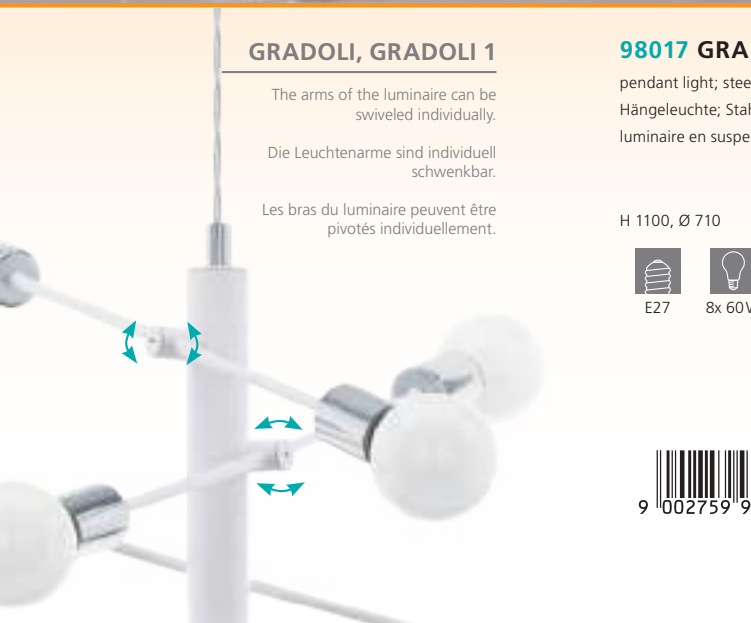

### GRADOLI, GRADOLI 1

The arms of the luminaire can be swiveled individually.

Die Leuchtenarme sind individuell schwenkbar.

Les bras du luminaire peuvent être pivotés individuellement.

### 98017 GRADOLI

pendant light; steel, white, chrome  
Hängeleuchte; Stahl, weiss, chrom  
luminaire en suspension; acier, blanc, chrome

H 1100, Ø 710



9 002759 980177

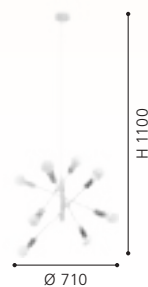

### 98016 GRADOLI

pendant light; steel, white, chrome  
Hängeleuchte; Stahl, weiss, chrom  
luminaire en suspension; acier, blanc, chrome

H 1100, Ø 550



9 002759 980160

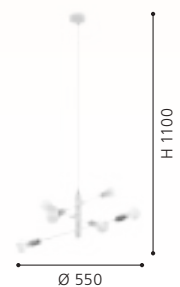



98835



MANIZALES



98834

### 99811 GRADOLI 1

pendant light; steel, brushed brass  
Hängeleuchte; Stahl, messing-gebürstet  
luminaire en suspension; acier, laiton brossé

H 1100, Ø 710



E27 8x 40W



9 002759 998110



### 98835 MANIZALES

pendant light; steel, brushed brass  
Hängeleuchte; Stahl, messing-gebürstet  
luminaire en suspension; acier, laiton brossé

L 1010, B 50, H 1100



E27 3x 40W



9 002759 988357



### 98834 MANIZALES

pendant light; steel, brushed brass  
Hängeleuchte; Stahl, messing-gebürstet  
luminaire en suspension; acier, laiton brossé

L 250, B 105, H 1100



E27 1x 40W



9 002759 988340





**900399**



**97733**

LED

**900399 CUMIOLE**

pendant light; steel, gold-coloured  
 Hängeleuchte; Stahl, goldfarben  
 luminaire en suspension; acier, or

L 780, B 150, H 1100



E27



3x 40W



9 008606 243754





97734



98858

### 97733 MONTEBALDO

pendant light; steel, black, gold  
Hängeleuchte; Stahl, schwarz, gold  
luminaire en suspension; acier, noir, or

L 100, B 100, H 1100

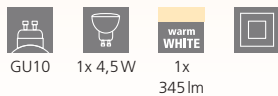

GU10 1x 4,5W  
warm WHITE  
1x  
345lm



### 97734 MONTEBALDO

pendant light; steel, black, gold  
Hängeleuchte; Stahl, schwarz, gold  
luminaire en suspension; acier, noir, or

L 850, B 100, H 1100



GU10 4x 4,5W  
warm WHITE  
4x  
345lm



### 98858 BITACHITO

pendant light; steel, black, brass  
Hängeleuchte; Stahl, schwarz, messing  
luminaire en suspension; acier, noir, laiton

L 930, B 55, H 1100



E27 4x 40W

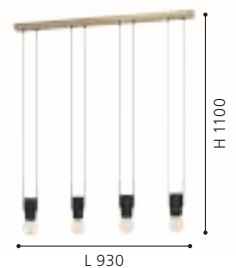



97604

LED

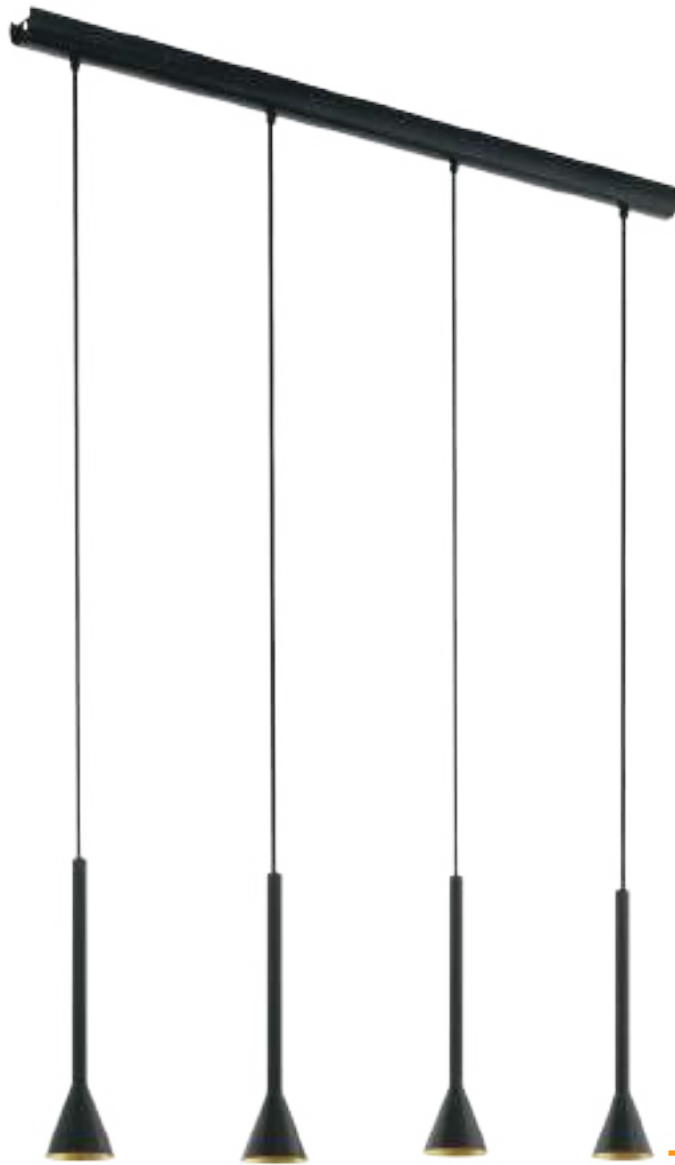

97605

LED



### 97604 CORTADERAS

pendant light; steel, black, gold  
Hängeleuchte; Stahl, schwarz, gold  
luminaire en suspension; acier, noir, or

H 1500, Ø 95



GU10



1x 4,8W



warm  
WHITE

1x

400lm



9 002759 976040



INCL.

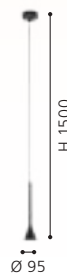

Ø 95

### 97605 CORTADERAS

pendant light; steel, black, gold  
Hängeleuchte; Stahl, schwarz, gold  
luminaire en suspension; acier, noir, or

L 1130, B 85, H 1500



GU10



4x 4,8W



warm  
WHITE

4x

400lm



9 002759 976057



INCL.

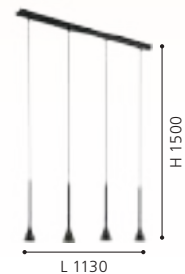

L 1130





**900977**



**900976**



**900975**

**900975, 900976, 900977**



These luminaires have a mains plug. The cable routing (total cable length 5.5 m) of these luminaires is individual, the fastening clips required for this are included in the scope of delivery.

Diese Leuchten haben einen Netzstecker. Die Kabelführung (Gesamtkabellänge 5,5 m) dieser Leuchten ist individuell, die dafür benötigten Befestigungsclips sind im Lieferumfang enthalten.

Ces luminaires sont équipés d'une fiche secteur. Le guidage du câble (longueur totale du câble : 5,5 m) de ces luminaires est individuel, les clips de fixation nécessaires sont compris dans la livraison.

**900977 RONDO 3**

pendant light; steel, plastic, black / matte-opal glass, white  
Hängeleuchte; Stahl, Kunststoff, schwarz / Glas opal-matt, weiss  
luminaire en suspension; acier, plastique, noir / verre opale mat, blanc

L 200, H 1420, A 400



E27 1x 40W

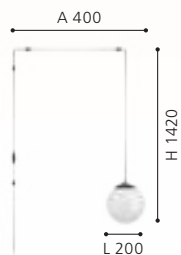

9 008606 282791

**900976 PINETINA**

pendant light; steel, black  
Hängeleuchte; Stahl, schwarz  
luminaire en suspension; acier, noir

L 45, H 1280, A 400



E27 1x 40W

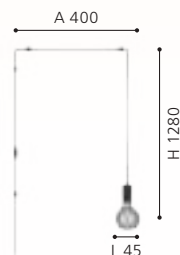

9 008606 281831

**900975 NARICES**

pendant light; steel, brushed brass, black  
Hängeleuchte; Stahl, messing-gebürstet, schwarz  
luminaire en suspension; acier, laiton brossé, noir

L 180, H 1420, A 400



E27 1x 40W

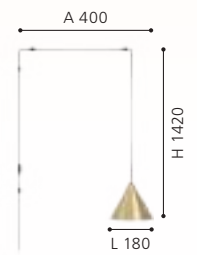

9 008606 281824



900401

LED



900402

LED

### 900401 SARONA

pendant light; steel, black, gold  
Hängeleuchte; Stahl, schwarz, gold  
luminaire en suspension; acier, noir, or

H 1100, Ø 210



GU10



1x 4,5W



1x  
warm  
WHITE  
345lm



9 008606 243761



### 900402 SARONA

pendant light; steel, black, gold  
Hängeleuchte; Stahl, schwarz, gold  
luminaire en suspension; acier, noir, or

L 910, B 50, H 1100



GU10



3x 4,5W



3x  
warm  
WHITE  
345lm



9 008606 243778





**99531**



**99532**

### 99531 LOBATIA

pendant light; steel, wood, black / terrazzo, grey, white  
 Hängeleuchte; Stahl, Holz, schwarz / Terrazzo, grau, weiss  
 luminaire en suspension; acier, bois, noir / terrazzo, gris, blanc

H 1100, Ø 105



E27



1x 40W



9 002759 995317

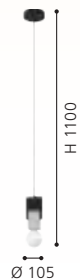

### 99532 LOBATIA

pendant light; steel, wood, black / terrazzo, grey, white  
 Hängeleuchte; Stahl, Holz, schwarz / Terrazzo, grau, weiss  
 luminaire en suspension; acier, bois, noir / terrazzo, gris, blanc

L 925, B 55, H 1100



E27



4x 40W



9 002759 995324

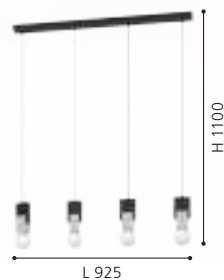



**95522**



**95523**

### 95522 SILVARES

pendant light; steel, grey / concrete, grey  
 Hängeleuchte; Stahl, grau / Beton, grau  
 luminaire en suspension; acier, gris / béton, gris

H 1100, Ø 110



E27 1x 60W



### 95523 SILVARES

pendant light; steel, grey / concrete, grey  
 Hängeleuchte; Stahl, grau / Beton, grau  
 luminaire en suspension; acier, gris / béton, gris

H 1500, Ø 250



E27 3x 60W





95525



95526

### 95525 TAREGA

pendant light; steel, grey / wood, concrete, brown, grey  
 Hängeleuchte; Stahl, grau / Holz, Beton, braun, grau  
 luminaire en suspension; acier, gris / bois, béton, marron, gris

H 1100, Ø 150



### 95526 TAREGA

pendant light; steel, grey / wood, concrete, brown, grey  
 Hängeleuchte; Stahl, grau / Holz, Beton, braun, grau  
 luminaire en suspension; acier, gris / bois, béton, marron, gris

H 1500, Ø 250





**99464**



### **GATUELA 1**

The lamp heads can be swiveled.

Die Leuchtenköpfe sind schwenkbar.

Les têtes de lampe peuvent être pivotées.

### **99464 GATUELA 1**

pendant light; steel, black

Hängeleuchte; Stahl, schwarz

luminaire en suspension; acier, noir

L 1160, B 190, H 1100



E14



6x 25W



9 002759 994648

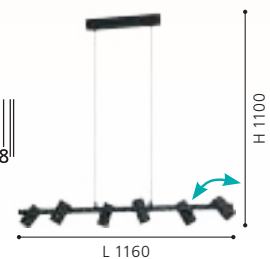

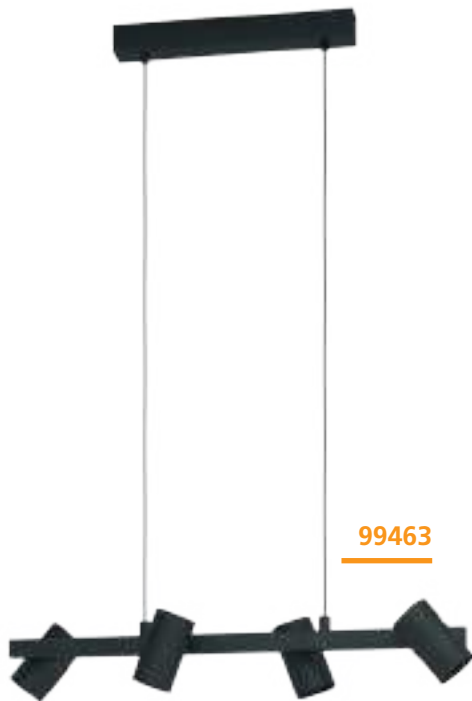

99463

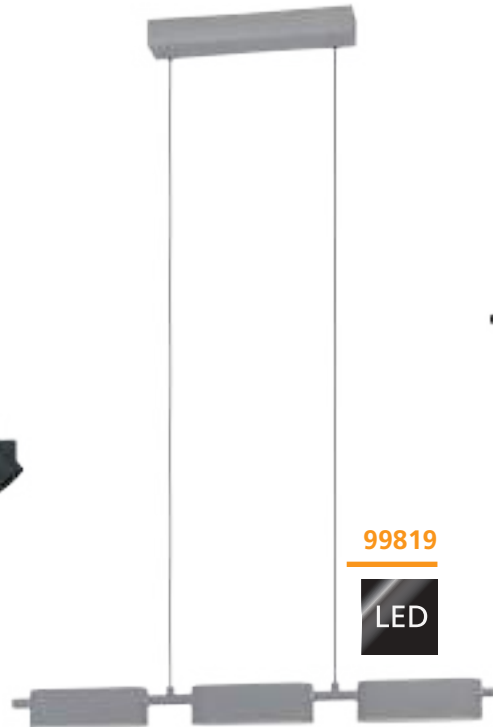

99819

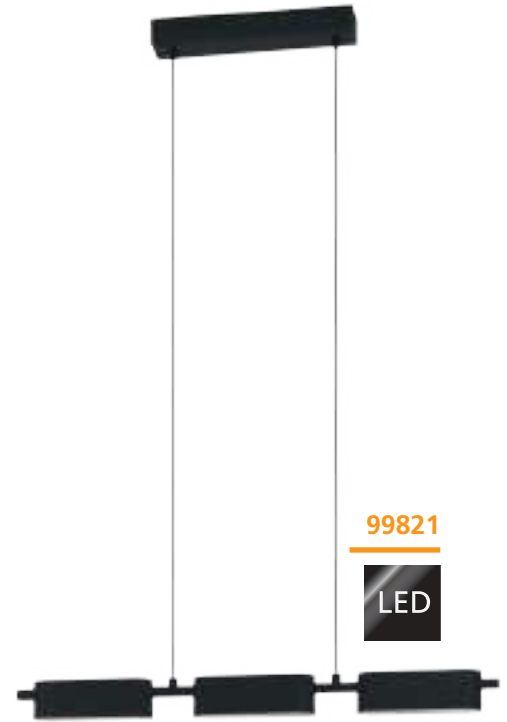

99821



### 99463 GATUELA 1

pendant light; steel, black  
Hängeleuchte; Stahl, schwarz  
luminaire en suspension; acier, noir

L 760, B 190, H 1100

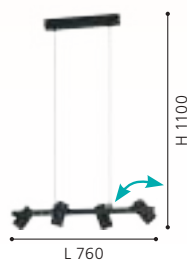
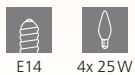

### 99819 ROVIRA

pendant light; aluminium, steel, silver / plastic, white  
Hängeleuchte; Alu, Stahl, silber / Kunststoff, weiss  
luminaire en suspension; aluminium, acier, argent / plastique, blanc

L 770, B 50, H 1100

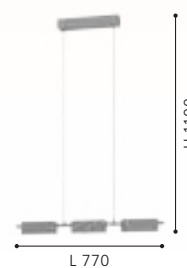

### 99821 ROVIRA

pendant light; aluminium, steel, black / plastic, white  
Hängeleuchte; Alu, Stahl, schwarz / Kunststoff, weiss  
luminaire en suspension; aluminium, acier, noir / plastique, blanc

L 770, B 50, H 1100

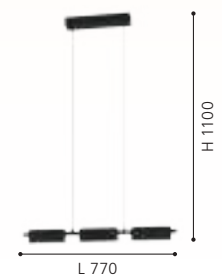



### 98492 AMONTILLADO

pendant light; aluminium, steel, black / plastic, white  
 Hängeleuchte; Alu, Stahl, schwarz / Kunststoff, weiss  
 luminaire en suspension; aluminium, acier, noir / plastique, blanc

L 1160, B 85, H 1100



2x 13,5W 3500lm



9 002759 984922

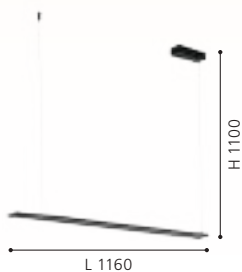

### 99599 CAMBULOS

pendant light; steel, black / plastic, white  
 Hängeleuchte; Stahl, schwarz / Kunststoff, weiss  
 luminaire en suspension; acier, noir / plastique, blanc

L 935, B 105, H 1100



2x 17W 4300lm



9 002759 995997



### 98495 SPADAFORA

pendant light; aluminium, steel, black / plastic, clear, white  
 Hängeleuchte; Alu, Stahl, schwarz / Kunststoff, klar, weiss  
 luminaire en suspension; aluminium, acier, noir / plastique, transparent, blanc

L 1160, B 80, H 1100



2x 7,5W 2000lm



9 002759 984953

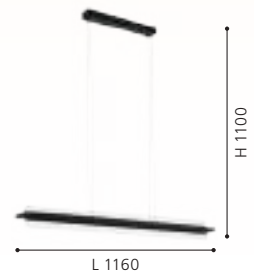





98836



### 98836 ERMUA

pendant light; steel, wood, black, brown / plastic, white  
Hängeleuchte; Stahl, Holz, schwarz, braun / Kunststoff, weiss  
luminaire en suspension; acier, bois, noir, marron / plastique, blanc

L 1000, B 165, H 1100



27W



3850lm



9 002759 988364

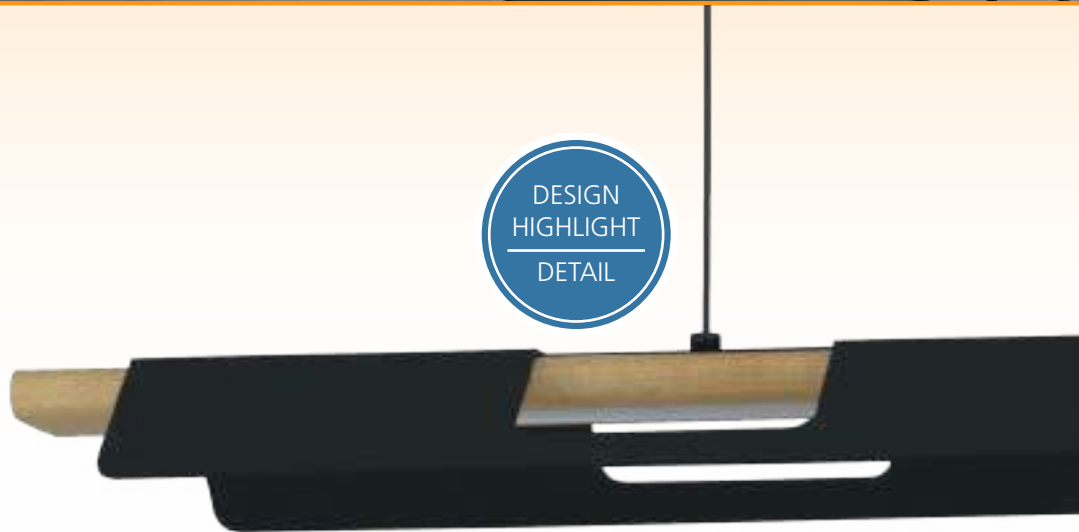
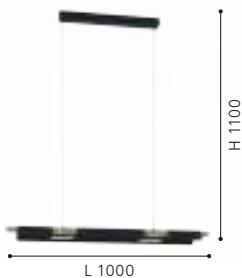

900175

LED





900174

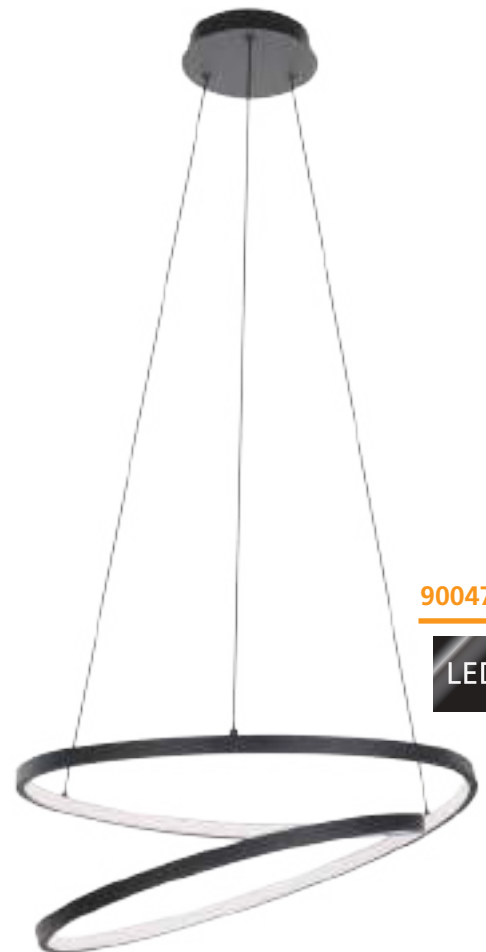

900472



### 900175 LISCIANA

pendant light; aluminium, steel, wood, grey / plastic, white  
 Hängeleuchte; Alu, Stahl, Holz, grau / Kunststoff, weiss  
 luminaire en suspension; aluminium, acier, bois, gris / plastique, blanc

L 1260, B 35, H 1100



22W 2500lm



9 008606 238088

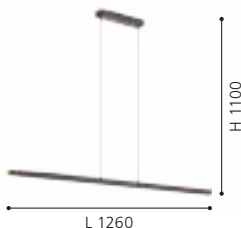

### 900174 LISCIANA

pendant light; aluminium, steel, wood, grey / plastic, white  
 Hängeleuchte; Alu, Stahl, Holz, grau / Kunststoff, weiss  
 luminaire en suspension; aluminium, acier, bois, gris / plastique, blanc

L 875, B 35, H 1100



18W 2000lm



9 008606 238071

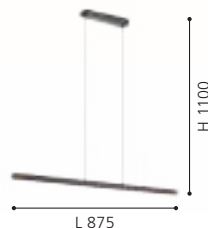

### 900472 RUOTALE

pendant light; aluminium, steel, black / plastic, white  
 Hängeleuchte; Alu, Stahl, schwarz / Kunststoff, weiss  
 luminaire en suspension; aluminium, acier, noir / plastique, blanc

H 1500, Ø 550



37W 4800lm



9 008606 239931





99818

LED



99249

LED

### 99818 SALITRE

pendant light; aluminium, black / plastic, white  
 Hängeleuchte; Alu, schwarz / Kunststoff, weiss  
 luminaire en suspension; aluminium, noir / plastique, blanc

H 1200, Ø 730



29W 4000lm

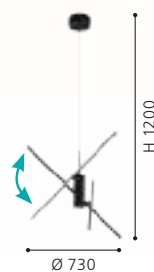

### 99249 CORREDERA

pendant light; steel, black / plastic, white  
 Hängeleuchte; Stahl, schwarz / Kunststoff, weiss  
 luminaire en suspension; acier, noir / plastique, blanc

H 1200, Ø 500



34W 5100lm

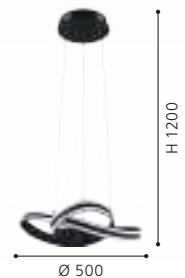



99697

LED



99698

LED

### 99697 BUTRANO

pendant light; steel, black, silver  
 Hängeleuchte; Stahl, schwarz, silber  
 luminaire en suspension; acier, noir, argent

L 55, B 55, H 1100

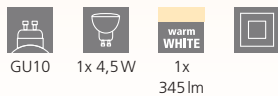

GU10 1x 4,5W 1x 345lm



9 002759 996970



L 55

### 99698 BUTRANO

pendant light; steel, black, silver  
 Hängeleuchte; Stahl, schwarz, silber  
 luminaire en suspension; acier, noir, argent

L 770, B 55, H 1100



GU10 3x 4,5W 3x 345lm



9 002759 996987

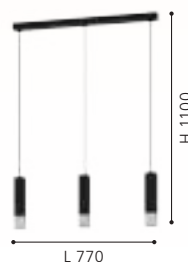

L 770



RAZONI | RAZONI 1

### 92252 RAZONI

pendant light; steel, black / satin glass, steel, black, white  
 Hängeleuchte; Stahl, schwarz / Glas satiniert, Stahl, schwarz, weiss  
 luminaire en suspension; acier, noir / verre satiné, acier, noir, blanc

H 1300, Ø 190



### 900828 RAZONI 1

pendant light; steel, black / steel, glass, black, white  
 Hängeleuchte; Stahl, schwarz / Stahl, Glas, schwarz, weiss  
 luminaire en suspension; acier, noir / acier, verre, noir, blanc

H 1100, Ø 425



### 94389 RAZONI

pendant light; steel, black / satin glass, steel, black, white  
 Hängeleuchte; Stahl, schwarz / Glas satiniert, Stahl, schwarz, weiss  
 luminaire en suspension; acier, noir / verre satiné, acier, noir, blanc

L 990, B 190, H 1100

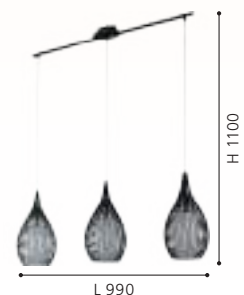



**92251**

**900829**

**94388**

**92251 RAZONI**

pendant light; steel, white / satin glass, steel, white  
 Hängeleuchte; Stahl, weiss / Glas satiniert, Stahl, weiss  
 luminaire en suspension; acier, blanc / verre satiné, acier, blanc

H 1300, Ø 190

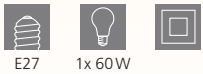

9 002759 922511

**900829 RAZONI 1**

pendant light; steel, white / steel, glass, white  
 Hängeleuchte; Stahl, weiss / Stahl, Glas, weiss  
 luminaire en suspension; acier, blanc / acier, verre, blanc

H 1100, Ø 425



Ø 190



9 008606 267965



Ø 425

**94388 RAZONI**

pendant light; steel, white / satin glass, steel, white  
 Hängeleuchte; Stahl, weiss / Glas satiniert, Stahl, weiss  
 luminaire en suspension; acier, blanc / verre satiné, acier, blanc

L 990, B 190, H 1100



9 002759 943882

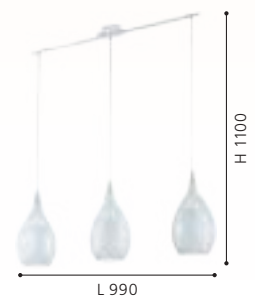

L 990



**97066**



**98689**

### 97066 ESTEVAU

pendant light; steel, dark brown  
 Hängeleuchte; Stahl, dunkelbraun  
 luminaire en suspension; acier, marron foncé

L 975, B 145, H 1100



E27



4x 60W



9 002759 970666



### 98689 OKINZURI

pendant light; steel, brass  
 Hängeleuchte; Stahl, messing  
 luminaire en suspension; acier, laiton

H 1100, Ø 450



E27



1x 60W



9 002759 986896





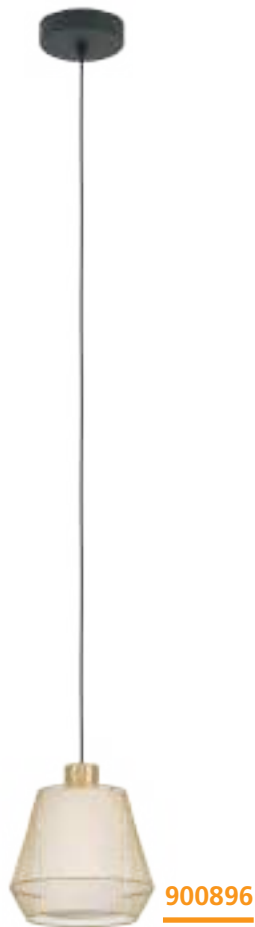

**900896**



900896



**900897**

### 900896 CIUADELA

pendant light; steel, black / steel, fabric, brushed brass, white  
 Hängeleuchte; Stahl, schwarz / Stahl, Textil, messing-gebürstet, weiss  
 luminaire en suspension; acier, noir / acier, tissu, laiton brossé, blanc

H 1100, Ø 180



E27 1x 40W



9 008606 274673



### 900897 CIUADELA

pendant light; steel, black / steel, fabric, brushed brass, white  
 Hängeleuchte; Stahl, schwarz / Stahl, Textil, messing-gebürstet, weiss  
 luminaire en suspension; acier, noir / acier, tissu, laiton brossé, blanc

L 880, B 180, H 1100



E27 3x 40W



9 008606 274680





EGLO  
RECOMMENDS  
**110033**

99635 | 99636

**99634**

**99636**

DESIGN  
HIGHLIGHT  
DETAIL

**99634 MASETA**

pendant light; steel, black / smoked glass, black-transparent  
Hängeleuchte; Stahl, schwarz / Rauchglas, schwarz-transparent  
luminaire en suspension; acier, noir / verre fumé, noir transparent

L 930, B 225, H 1100



E27 3x 40W



9 002759 996345



**99636 MASETA**

pendant light; steel, gold-coloured / matte-opal glass, white  
Hängeleuchte; Stahl, goldfarben / Glas opal-matt, weiss  
luminaire en suspension; acier, or / verre opale mat, blanc

L 930, B 225, H 1100



E27 3x 40W



9 002759 996369



**99635 MASETA**

pendant light; steel, gold-coloured / matte-opal glass, white  
Hängeleuchte; Stahl, goldfarben / Glas opal-matt, weiss  
luminaire en suspension; acier, or / verre opale mat, blanc

H 1100, Ø 225



E27 1x 40W



9 002759 996352





99635



99633 | 99634

## 99633 MASETA

pendant light; steel, black / smoked glass, black-transparent  
Hängeleuchte; Stahl, schwarz / Rauchglas, schwarz-transparent  
luminaire en suspension; acier, noir / verre fumé, noir transparent

H 1100, Ø 225



E27



1x 40W



99633



### 99705 FLORESTA

pendant light; steel, black / glass vaporized, black-transparent  
 Hängeleuchte; Stahl, schwarz / Glas bedampft, schwarz-transparent  
 luminaire en suspension; acier, noir / verre vaporisé, noir transparent

H 1100, Ø 195



### 99706 FLORESTA

pendant light; steel, black / glass vaporized, black-transparent  
 Hängeleuchte; Stahl, schwarz / Glas bedampft, schwarz-transparent  
 luminaire en suspension; acier, noir / verre vaporisé, noir transparent

L 890, B 190, H 1100



### 99707 ZOCABON

pendant light; steel, black / glass, clear  
 Hängeleuchte; Stahl, schwarz / Glas, klar  
 luminaire en suspension; acier, noir / verre, transparent

L 815, B 110, H 1100



99707





99618



99619



DESIGN  
HIGHLIGHT  
DETAIL

### 99618 MULEGES

pendant light; steel, black / matte-opal glass, white  
Hängeleuchte; Stahl, schwarz / Glas opal-matt, weiss  
luminaire en suspension; acier, noir / verre opale mat, blanc

H 1100, Ø 160



E27 1x 40W



9 002759 996185

### 99619 MULEGES

pendant light; steel, black / matte-opal glass, white  
Hängeleuchte; Stahl, schwarz / Glas opal-matt, weiss  
luminaire en suspension; acier, noir / verre opale mat, blanc

L 960, B 160, H 1100



E27 3x 40W



9 002759 996192





**900867**

**900866**

**900867 TERRAROSA**

pendant light; steel, sandy / fabric, white  
 Hängeleuchte; Stahl, sandfarben / Textil, weiss  
 luminaire en suspension; acier, couleur sable / tissu, blanc

H 1100, Ø 285



**900866 TERRAROSA**

pendant light; steel, sandy / fabric, white  
 Hängeleuchte; Stahl, sandfarben / Textil, weiss  
 luminaire en suspension; acier, couleur sable / tissu, blanc

H 1100, Ø 240



TERRAROSA



99661



99662

### 99661 CURASAO

pendant light; steel, black / steel, fabric, black, gold  
 Hängeleuchte; Stahl, schwarz / Stahl, Textil, schwarz, gold  
 luminaire en suspension; acier, noir / acier, tissu, noir, or

H 1100, Ø 335



### 99662 CURASAO

pendant light; steel, black / steel, fabric, black, gold  
 Hängeleuchte; Stahl, schwarz / Stahl, Textil, schwarz, gold  
 luminaire en suspension; acier, noir / acier, tissu, noir, or

L 995, B 235, H 1100







**99665**

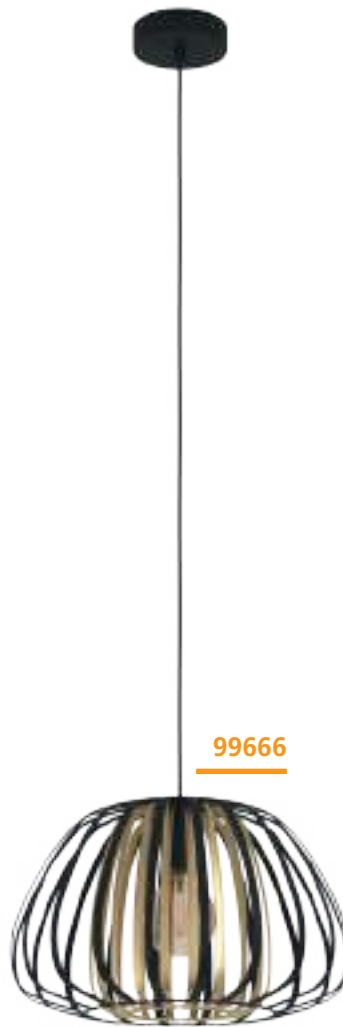

**99666**



### 99665 ENCINITOS

pendant light; steel, black, gold  
Hängeleuchte; Stahl, schwarz, gold  
luminaire en suspension; acier, noir, or

H 1100, Ø 255



E27 1x 40W



9 002759 996659



### 99666 ENCINITOS

pendant light; steel, black, gold  
Hängeleuchte; Stahl, schwarz, gold  
luminaire en suspension; acier, noir, or

H 1100, Ø 375



E27 1x 40W



9 002759 996666





99694

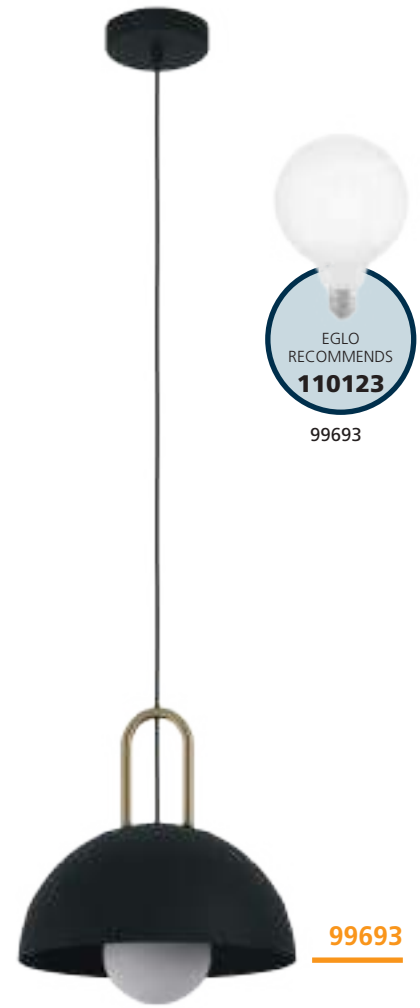

99693

99693

### 99694 CALMANERA

pendant light; steel, black, brass  
 Hängeleuchte; Stahl, schwarz, messing  
 luminaire en suspension; acier, noir, laiton

L 900, B 200, H 1100



### 99693 CALMANERA

pendant light; steel, black, brass  
 Hängeleuchte; Stahl, schwarz, messing  
 luminaire en suspension; acier, noir, laiton

H 1100, Ø 325





99695 | 99696



99696

99695

### 99696 CALMANERA

pendant light; steel, white, brass  
 Hängeleuchte; Stahl, weiss, messing  
 luminaire en suspension; acier, blanc, laiton

L 900, B 200, H 1100



9 002759 996963

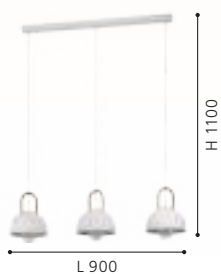

### 99695 CALMANERA

pendant light; steel, white, brass  
 Hängeleuchte; Stahl, weiss, messing  
 luminaire en suspension; acier, blanc, laiton

H 1100, Ø 325

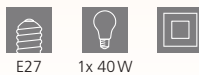

9 002759 996956

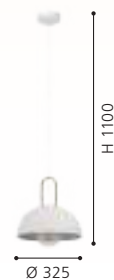



900429

### 900429 VALDIOLA

pendant light; steel, sandy, brushed brass  
 Hängeleuchte; Stahl, sandfarben, messing-gebürstet  
 luminaire en suspension; acier, couleur sable, laiton brossé

H 1100, Ø 360



E27 1x 40W



9 008606 240562

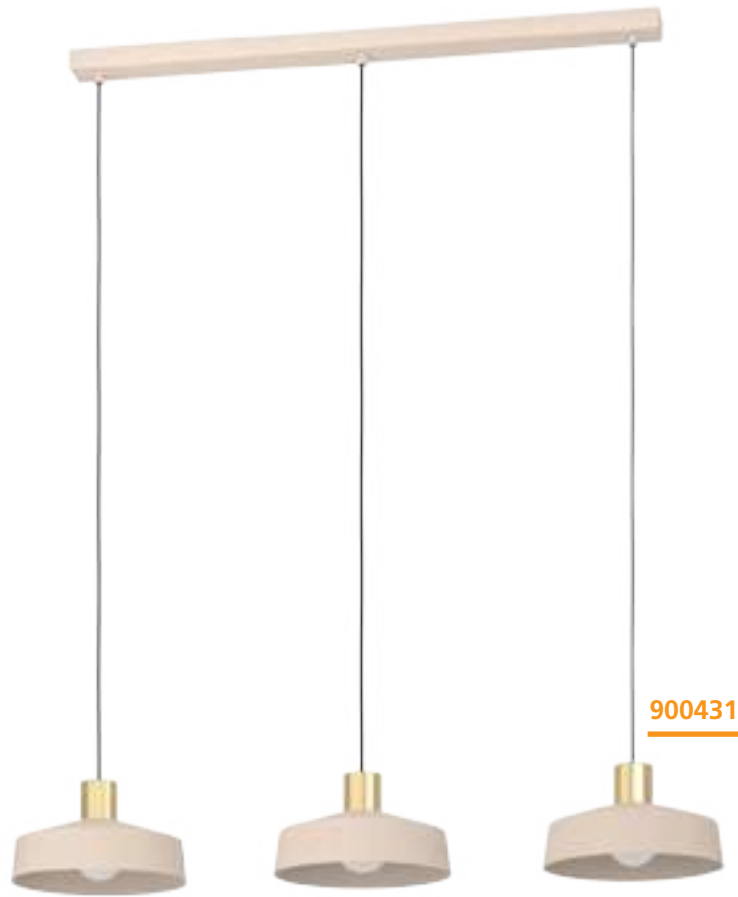
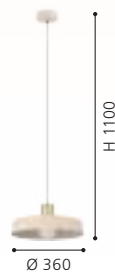

900431

### 900431 VALDIOLA

pendant light; steel, sandy, brushed brass  
 Hängeleuchte; Stahl, sandfarben, messing-gebürstet  
 luminaire en suspension; acier, couleur sable, laiton brossé

L 930, B 230, H 1100



E27 3x 40W



9 008606 240579

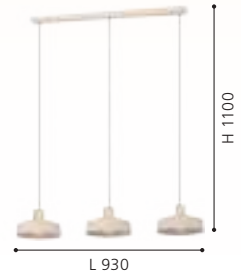

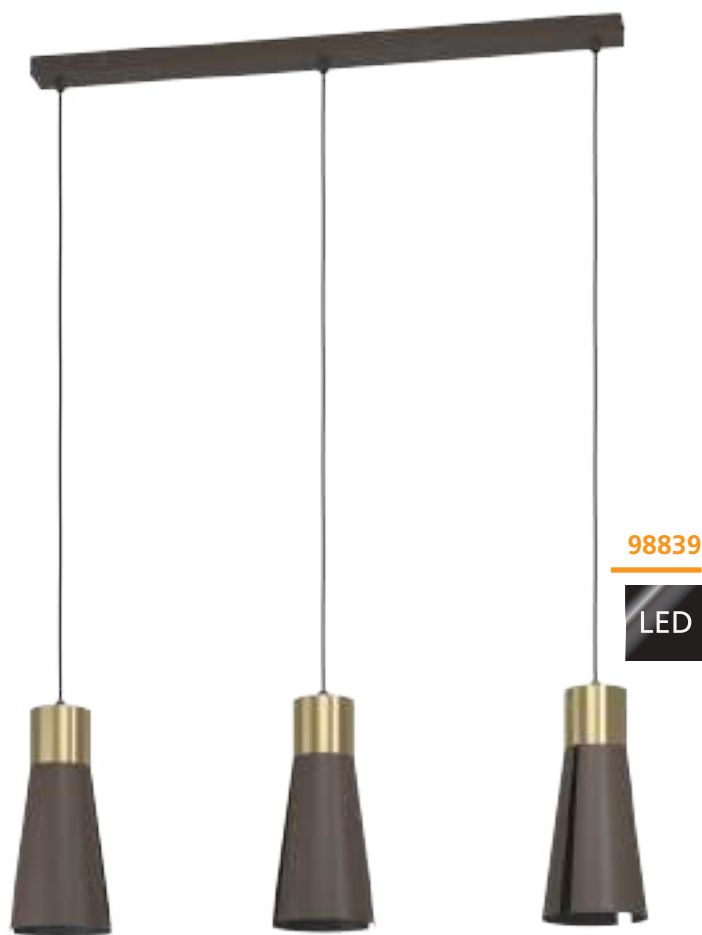

98839

LED



98838

LED

### 98839 LOSALOMAS

pendant light; steel, mocha-coloured, brushed brass  
Hängeleuchte; Stahl, Mokkafarben, messing-gebürstet  
luminaire en suspension; acier, café, laiton brossé

L 835, B 135, H 1100



GU10 3x 4,5W 3x 345lm



9 002759 988395

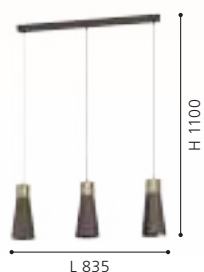

### 98838 LOSALOMAS

pendant light; steel, mocha-coloured, brushed brass  
Hängeleuchte; Stahl, Mokkafarben, messing-gebürstet  
luminaire en suspension; acier, café, laiton brossé

H 1100, Ø 135

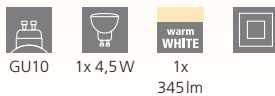

GU10 1x 4,5W 1x 345lm



9 002759 988388

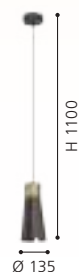



### 900425 BOLIVIA

pendant light; steel, black / steel, black, sandy  
 Hängeleuchte; Stahl, schwarz / Stahl, schwarz, sandfarben  
 luminaire en suspension; acier, noir / acier, noir, couleur sable

H 1100, Ø 180



### 900426 BOLIVIA

pendant light; steel, black / steel, black, sandy  
 Hängeleuchte; Stahl, schwarz / Stahl, schwarz, sandfarben  
 luminaire en suspension; acier, noir / acier, noir, couleur sable

L 880, B 180, H 1100



### 900143 CAMBAITO

pendant light; steel, sandy  
 Hängeleuchte; Stahl, sandfarben  
 luminaire en suspension; acier, couleur sable

L 895, B 195, H 1100

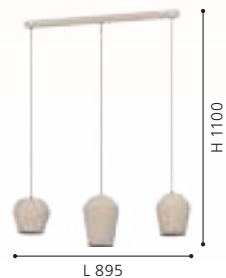



**900158**



**900159**

### 900158 CAMASCA

pendant light; steel, black  
Hängeleuchte; Stahl, schwarz  
luminaire en suspension; acier, noir

H 500 - 1100, Ø 280

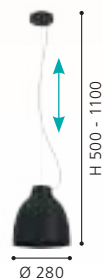

### 900159 CAMASCA

pendant light; steel, taupe  
Hängeleuchte; Stahl, taupe  
luminaire en suspension; acier, taupe

H 500 - 1100, Ø 280



### CAMASCA

These luminaires are height adjustable.  
Diese Leuchten sind höhenverstellbar.  
Ces luminaires sont réglables en hauteur.





**900836**

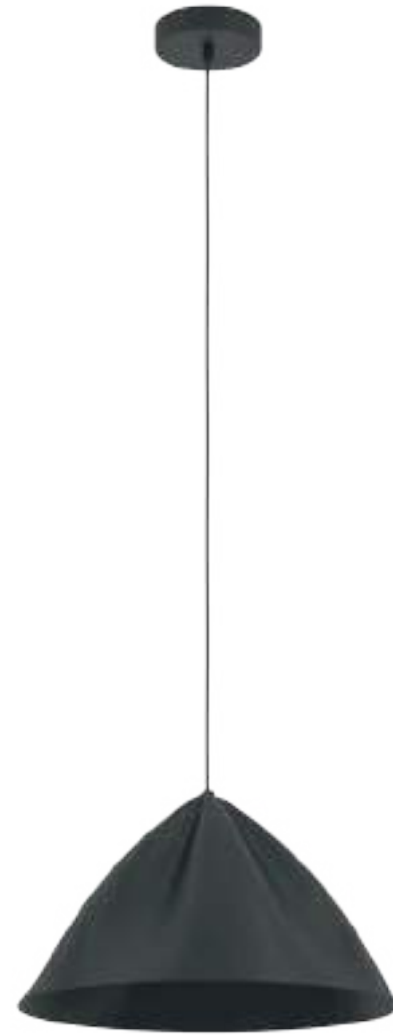

**900835**

**900836 PODERE**

pendant light; steel, sandy  
 Hängeleuchte; Stahl, sandfarben  
 luminaire en suspension; acier, couleur sable

H 1100, Ø 425



E27 1x 40W



**900835 PODERE**

pendant light; steel, black  
 Hängeleuchte; Stahl, schwarz  
 luminaire en suspension; acier, noir

H 1100, Ø 425



E27 1x 40W







900346

### 900346 GAZZOLA

pendant light; steel, mocha-coloured, sandy  
 Hängeleuchte; Stahl, Mokka, Sandfarben  
 luminaire en suspension; acier, café, couleur sable

L 910, B 150, H 1100

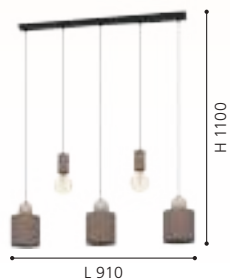



**99439**



**99438**



**99439 SEGEZIA**

pendant light; steel, mocha-coloured / steel, mocha colour, gold  
 Hängeleuchte; Stahl, Mokkafarben / Stahl, Mokka, gold  
 luminaire en suspension; acier, café / acier, Mokka, or

H 1100, Ø 350



9 002759 994396



**99438 SEGEZIA**

pendant light; steel, mocha-coloured / steel, mocha colour, gold  
 Hängeleuchte; Stahl, Mokkafarben / Stahl, Mokka, gold  
 luminaire en suspension; acier, café / acier, Mokka, or

L 880, B 180, H 1100



9 002759 994389





### 98353 RAMON

pendant light; steel, black / film, white  
 Hängeleuchte; Stahl, schwarz / Folie, weiss  
 luminaire en suspension; acier, noir / film, blanc

L 860, B 160, H 1100

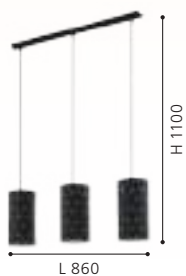

### 98071 CAMASTRA

pendant light; steel, black, gold  
 Hängeleuchte; Stahl, schwarz, gold  
 luminaire en suspension; acier, noir, or

H 1100, Ø 225

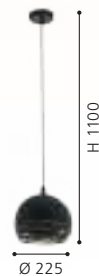

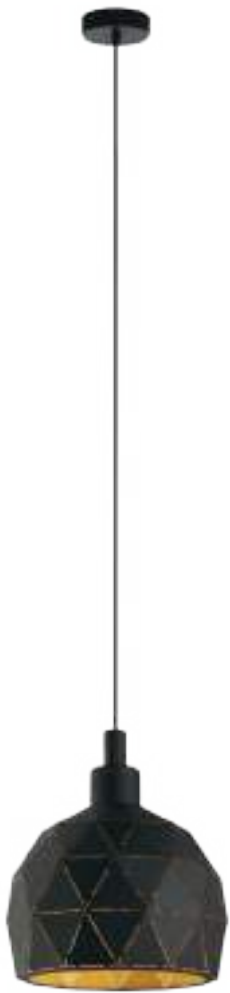

33345



97845



97841

### 33345 ROCCAFORTE

pendant light; steel, black, gold  
Hängeleuchte; Stahl, schwarz, gold  
luminaire en suspension; acier, noir, or

H 1100, Ø 170



E14 1x 40W



9 002759 333454

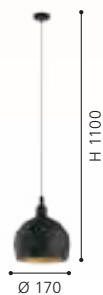

### 97845 ROCCAFORTE

pendant light; steel, black, gold  
Hängeleuchte; Stahl, schwarz, gold  
luminaire en suspension; acier, noir, or

H 1100, Ø 300

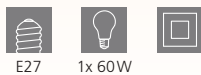

E27 1x 60W



9 002759 978457



### 97841 ROCCAFORTE

pendant light; steel, black, gold  
Hängeleuchte; Stahl, schwarz, gold  
luminaire en suspension; acier, noir, or

H 1100, Ø 400



E27 1x 60W



9 002759 978419





97846

### 97846 ROCCAFORTE

pendant light; steel, black, gold  
Hängeleuchte; Stahl, schwarz, gold  
luminaire en suspension; acier, noir, or

L 750, B 170, H 1100

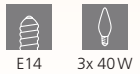

9 002759 978464

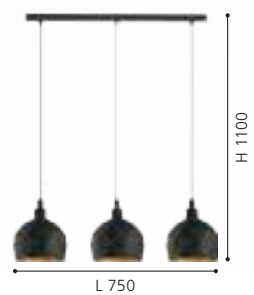



33344



97854

### 33344 ROCCAFORTE

pendant light; steel, white  
Hängeleuchte; Stahl, weiss  
luminaire en suspension; acier, blanc

H 1100, Ø 170



E14



1x 40W



9 002759 333447





**97855**

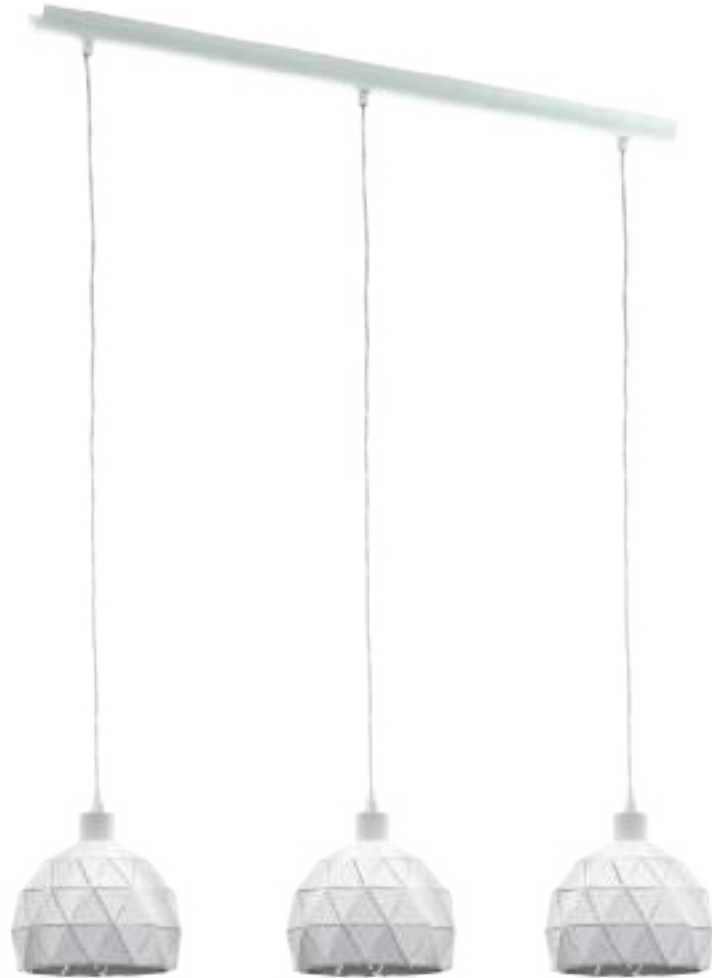

**97857**

### 97854 ROCCAFORTE

pendant light; steel, white  
Hängeleuchte; Stahl, weiss  
luminaire en suspension; acier, blanc

H 1100, Ø 300



E27 1x 60W



9 002759 978549

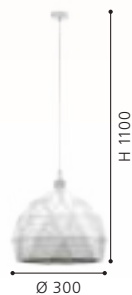

### 97855 ROCCAFORTE

pendant light; steel, white  
Hängeleuchte; Stahl, weiss  
luminaire en suspension; acier, blanc

H 1100, Ø 400



E27 1x 60W



9 002759 978556



### 97857 ROCCAFORTE

pendant light; steel, white  
Hängeleuchte; Stahl, weiss  
luminaire en suspension; acier, blanc

L 750, B 170, H 1100



E14 3x 40W



9 002759 978570





**93373**



**93374**

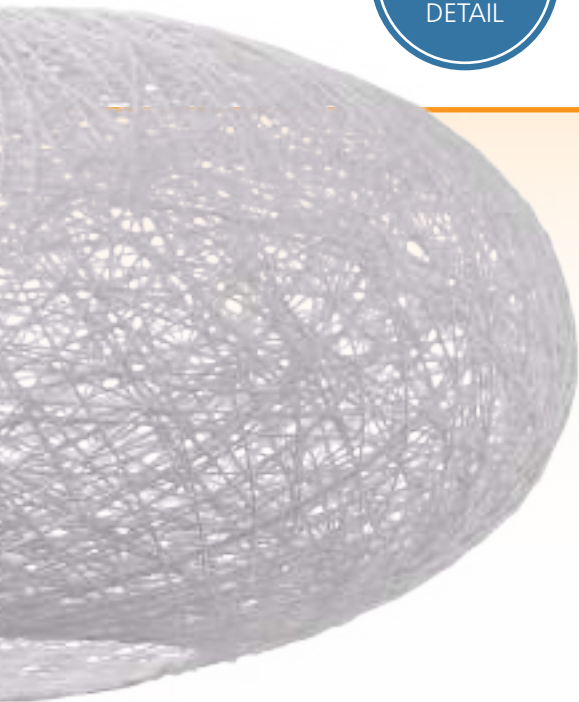

**93373 CAMPILO**

pendant light; plastic, white / paper threads, white  
 Hängeleuchte; Kunststoff, weiss / Papierfäden, weiss  
 luminaire en suspension; plastique, blanc / fils de papier, blanc

H 1100, Ø 450



9 002759 933739



**93374 CAMPILO**

pendant light; plastic, white / paper threads, beige  
 Hängeleuchte; Kunststoff, weiss / Papierfäden, beige  
 luminaire en suspension; plastique, blanc / fils de papier, beige

H 1100, Ø 450



9 002759 933746







95385



95383

### 95385 OBREGON

pendant light; steel, brown, cream, oak  
 Hängeleuchte; Stahl, braun, creme, eiche  
 luminaire en suspension; acier, marron, crème, chêne

H 1100, Ø 350



E27 1x 60W



9 002759 953850



### 95383 OBREGON

pendant light; steel, cream, oak  
 Hängeleuchte; Stahl, creme, eiche  
 luminaire en suspension; acier, crème, chêne

H 1100, Ø 350



E27 1x 60W



9 002759 953836





900161



900162



900163



### 900161 SABINAR

pendant light; steel, wood, black, brown  
Hängeleuchte; Stahl, Holz, schwarz, braun  
luminaire en suspension; acier, bois, noir, marron

H 1100, Ø 180



E27



1x 40W



9 008606 235773

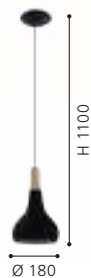

Ø 180

### 900162 SABINAR

pendant light; steel, wood, black, brown  
Hängeleuchte; Stahl, Holz, schwarz, braun  
luminaire en suspension; acier, bois, noir, marron

H 1100, Ø 280



E27



1x 40W



9 008606 235780



Ø 280

### 900163 SABINAR

pendant light; steel, wood, black, brown  
Hängeleuchte; Stahl, Holz, schwarz, braun  
luminaire en suspension; acier, bois, noir, marron

H 1100, Ø 400



E27



1x 40W



9 008606 235797



Ø 400



**96981**



**96982**



**96983**

### 96981 SABINAR

pendant light; steel, white / wood, brown  
Hängeleuchte; Stahl, weiss / Holz, braun  
luminaire en suspension; acier, blanc / bois, marron

H 1100, Ø 180



9 002759 969813



### 96982 SABINAR

pendant light; steel, white / wood, brown  
Hängeleuchte; Stahl, weiss / Holz, braun  
luminaire en suspension; acier, blanc / bois, marron

H 1100, Ø 280



9 002759 969820

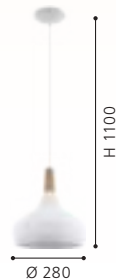

### 96983 SABINAR

pendant light; steel, white / wood, brown  
Hängeleuchte; Stahl, weiss / Holz, braun  
luminaire en suspension; acier, blanc / bois, marron

H 1100, Ø 400



9 002759 969837

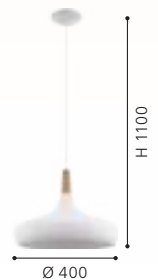



96985





**96986**



### 96985 SABINAR

pendant light; steel, brushed silver / wood, brown  
 Hängeleuchte; Stahl, silber gebürstet / Holz, braun  
 luminaire en suspension; acier, argent brossé / bois, marron

H 1100, Ø 280



E27 1x 60W



9 002759 969851

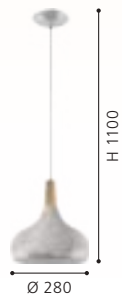

### 96986 SABINAR

pendant light; steel, brushed silver / wood, brown  
 Hängeleuchte; Stahl, silber gebürstet / Holz, braun  
 luminaire en suspension; acier, argent brossé / bois, marron

H 1100, Ø 400



E27 1x 60W



9 002759 969868

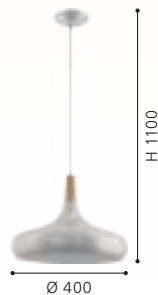



900186

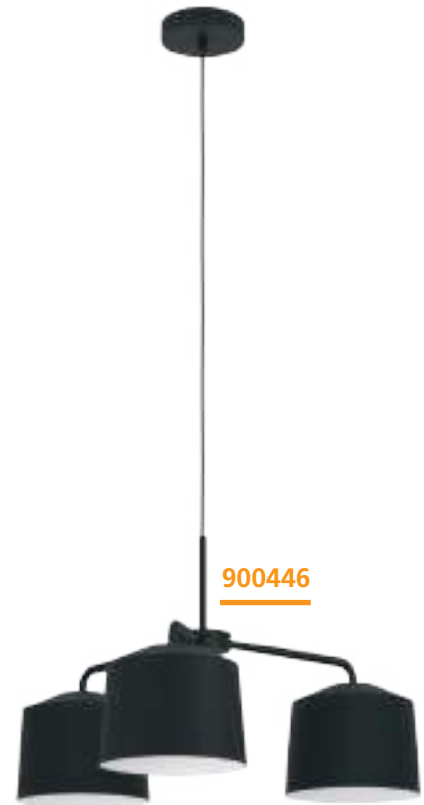

900446



### 900186 FILAGO

pendant light; steel, wood, black, brown / glass, black-grey-transparent  
 Hängeleuchte; Stahl, Holz, schwarz, braun / Glas, schwarz-grau-transparent  
 luminaire en suspension; acier, bois, noir, marron / verre, noir gris transparent

L 880, B 145, H 1100



E27



4x 40W



9 008606 235339



### 900446 CAGUANES

pendant light; steel, black, white  
 Hängeleuchte; Stahl, schwarz, weiss  
 luminaire en suspension; acier, noir, blanc

H 1100, Ø 665



E27



3x 40W



9 008606 243969

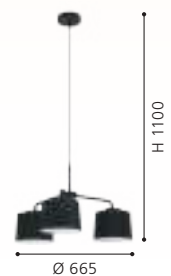



### 99702 VIGLIONI

pendant light; steel, wood, black, brown / glass vaporized, black-transparent

Hängeleuchte; Stahl, Holz, schwarz, braun / Glas bedampft, schwarz-transparent

luminaire en suspension; acier, bois, noir, marron / verre vaporisé, noir transparent

L 1060, B 165, H 1100



E27 3x 40W



9 002759 997021

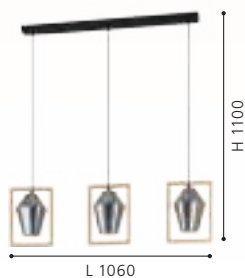

L 1060

### 99701 VIGLIONI

pendant light; steel, wood, black, brown / glass vaporized, black-transparent

Hängeleuchte; Stahl, Holz, schwarz, braun / Glas bedampft, schwarz-transparent

luminaire en suspension; acier, bois, noir, marron / verre vaporisé, noir transparent

L 230, B 165, H 1100



E27 1x 40W



9 002759 997014



L 230

### 900444 TARRAFO

pendant light; steel, wood, black, brown

Hängeleuchte; Stahl, Holz, schwarz, braun

luminaire en suspension; acier, bois, noir, marron

L 880, B 150, H 1100



E27 4x 40W



9 008606 243952

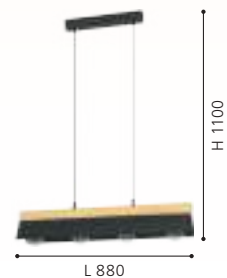

L 880

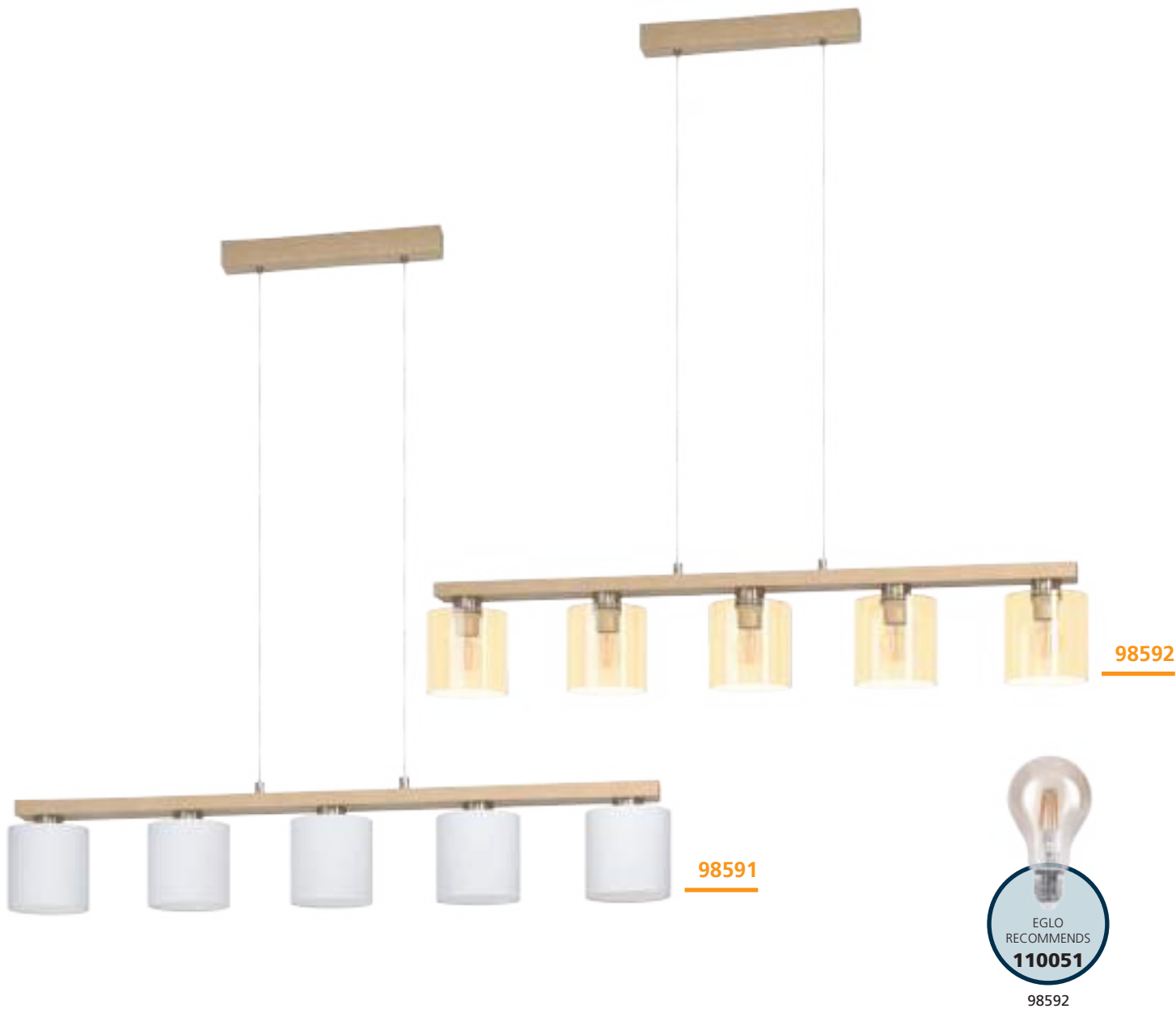

### 98591 CASTRALVO

pendant light; steel, wood, satin nickel, brown / fabric, white  
 Hängeleuchte; Stahl, Holz, nickel-matt, braun / Textil, weiss  
 luminaire en suspension; acier, bois, nickel mat, marron / tissu, blanc

L 1210, B 150, H 1100



E27 5x 28W



9 002759 985912

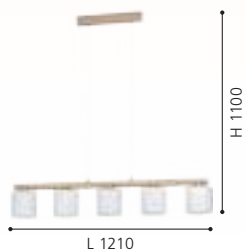

### 98592 CASTRALVO

pendant light; steel, wood, satin nickel, brown / glass vaporized, amber  
 Hängeleuchte; Stahl, Holz, nickel-matt, braun / Glas bedampft, amber  
 luminaire en suspension; acier, bois, nickel mat, marron / verre vaporisé, ambre

L 1210, B 150, H 1100



E27 5x 28W



9 002759 985929

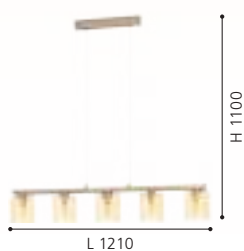

### 900313 CASTRALVO

pendant light; wood, steel, brown / fabric, black  
 Hängeleuchte; Holz, Stahl, braun / Textil, schwarz  
 luminaire en suspension; bois, acier, marron / tissu, noir

L 975, B 175, H 1100



E27 3x 40W



9 008606 235872

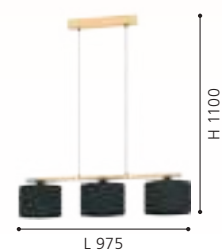



900313





## CONTRISA

These luminaires are open at the top and have a beautiful play of light.

Diese Leuchten sind nach oben offen und haben ein schönes Lichtspiel.

Ces luminaires sont ouverts vers le haut et ont un beau jeu de lumière.

### 900381 CONTRISA

pendant light; steel, grey  
Hängeleuchte; Stahl, grau  
luminaire en suspension; acier, gris

H 1100, Ø 520

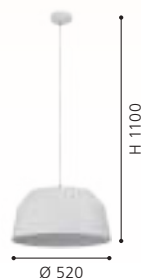

### 900379 CONTRISA

pendant light; steel, grey  
Hängeleuchte; Stahl, grau  
luminaire en suspension; acier, gris

H 1100, Ø 380



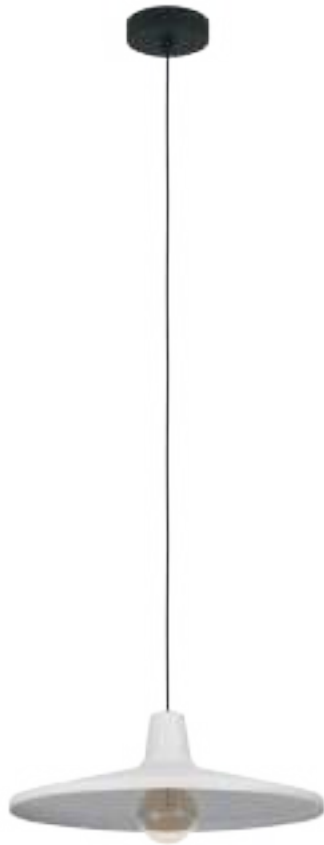

900833



MINIERE



900834

### 900362 MARIEL

pendant light; steel, wood, light grey, brown  
 Hängeleuchte; Stahl, Holz, hellgrau, braun  
 luminaire en suspension; acier, bois, gris clair, marron

L 910, B 190, H 1100

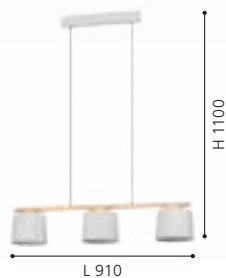

### 900833 MINIERE

pendant light; steel, black / steel, grey  
 Hängeleuchte; Stahl, schwarz / Stahl, grau  
 luminaire en suspension; acier, noir / acier, gris

H 1100, Ø 420

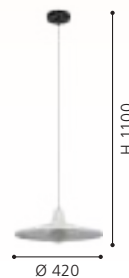

### 900834 MINIERE

pendant light; steel, black / steel, grey  
 Hängeleuchte; Stahl, schwarz / Stahl, grau  
 luminaire en suspension; acier, noir / acier, gris

L 995, B 420, H 1100

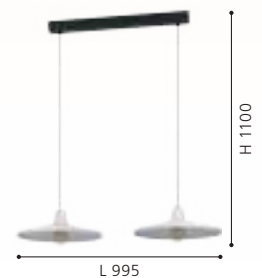



**900696**

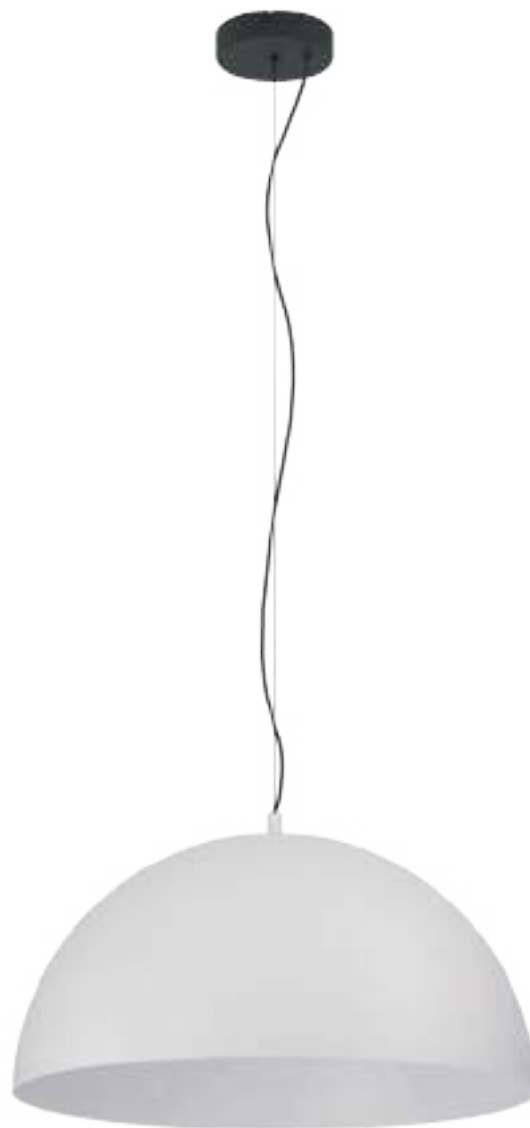

**900697**

### 900696 GAETANO 1

pendant light; steel, black / steel, sandy, cream  
 Hängeleuchte; Stahl, schwarz / Stahl, sandfarben, creme  
 luminaire en suspension; acier, noir / acier, couleur sable, crème

H 1500, Ø 535



E27 1x 40W



### 900697 GAETANO 1

pendant light; steel, black / steel, grey, white  
 Hängeleuchte; Stahl, schwarz / Stahl, grau, weiss  
 luminaire en suspension; acier, noir / acier, gris, blanc

H 1500, Ø 535



E27 1x 40W





94936



94935

### 94936 GAETANO 1

pendant light; steel, black, gold  
Hängeleuchte; Stahl, schwarz, gold  
luminaire en suspension; acier, noir, or

H 1500, Ø 530



E27



1x 60W



9 002759 949365



### 94935 GAETANO 1

pendant light; steel, black, gold  
Hängeleuchte; Stahl, schwarz, gold  
luminaire en suspension; acier, noir, or

H 1500, Ø 380



E27



1x 60W



9 002759 949358

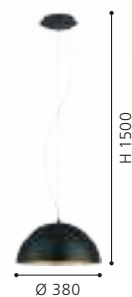



900849



### 900849 CENCIARA

pendant light; steel, black / steel, brushed brass, gold  
 Hängeleuchte; Stahl, schwarz / Stahl, messing-gebürstet, gold  
 luminaire en suspension; acier, noir / acier, laiton brossé, or

H 1100, Ø 400

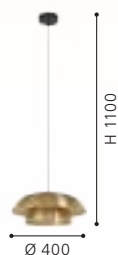

### 95755 NUVANO

pendant light; steel, brown, gold  
 Hängeleuchte; Stahl, braun, gold  
 luminaire en suspension; acier, marron, or

H 1100, Ø 480



### 99663 NUVANO

pendant light; steel, black, gold  
 Hängeleuchte; Stahl, schwarz, gold  
 luminaire en suspension; acier, noir, or

L 985, B 225, H 1100

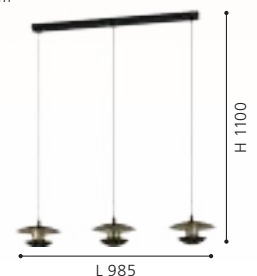
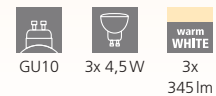



94938

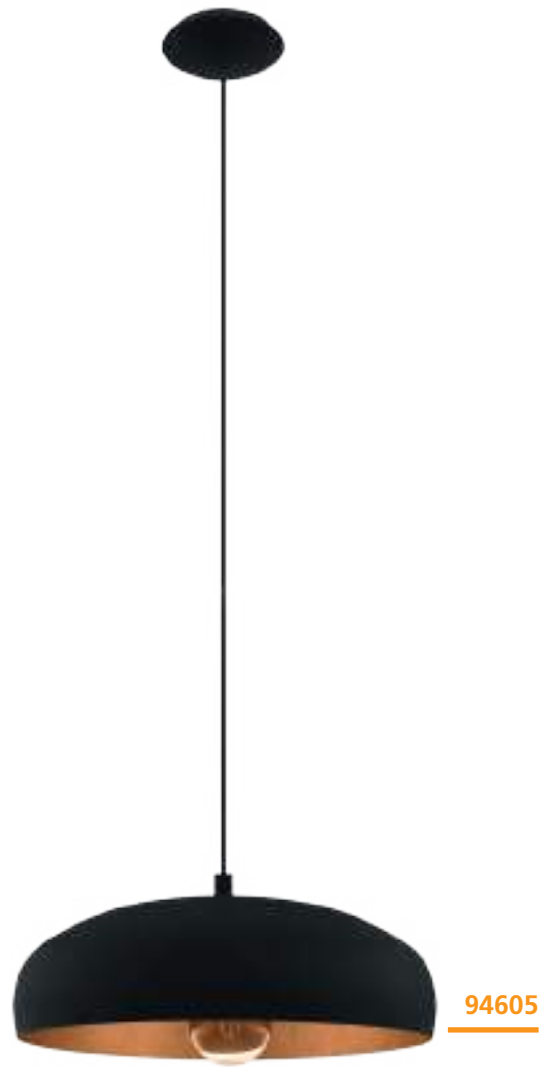

94605

### 94938 GAETANO 1

pendant light; steel, black, copper  
 Hängeleuchte; Stahl, schwarz, kupfer  
 luminaire en suspension; acier, noir, cuivre

H 1500, Ø 530



E27 1x 60W



9 002759 949389



### 94605 MOGANO 1

pendant light; steel, black, copper  
 Hängeleuchte; Stahl, schwarz, kupfer  
 luminaire en suspension; acier, noir, cuivre

H 1100, Ø 400



E27 1x 60W



9 002759 946050



### 94606 MOGANO 1

pendant light; steel, white, copper  
 Hängeleuchte; Stahl, weiss, kupfer  
 luminaire en suspension; acier, blanc, cuivre

H 1100, Ø 400



E27 1x 60W



9 002759 946067







94606



**98735**

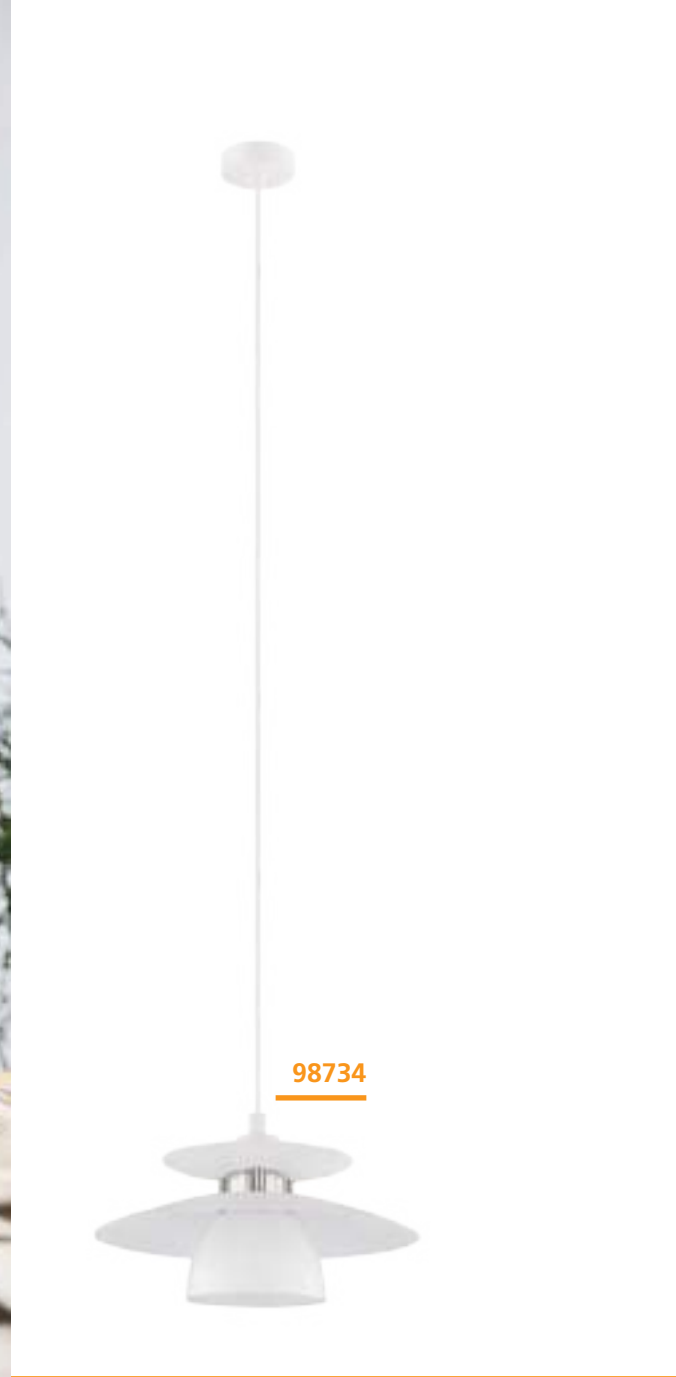

**98734**

**98735 BRENDA**

pendant light; steel, black, satin nickel  
 Hängeleuchte; Stahl, schwarz, nickel-matt  
 luminaire en suspension; acier, noir, nickel mat

H 1500, Ø 320



**98734 BRENDA**

pendant light; steel, white, satin nickel  
 Hängeleuchte; Stahl, weiss, nickel-matt  
 luminaire en suspension; acier, blanc, nickel mat

H 1500, Ø 320





87055



31666

### 87055 BRENDA

pendant light; plastic, steel, white, chrome / steel, white  
 Hängeleuchte; Kunststoff, Stahl, weiss, chrom / Stahl, weiss  
 luminaire en suspension; plastique, acier, blanc, chrome / acier, blanc

H 1300, Ø 430

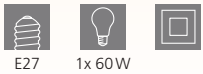

E27 1x 60W



9 002759 870553

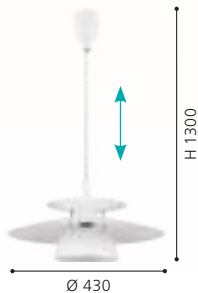

### 31666 BRENDA

pendant light; plastic, steel, black / steel, black, copper  
 Hängeleuchte; Kunststoff, Stahl, schwarz / Stahl, schwarz, kupfer  
 luminaire en suspension; plastique, acier, noir / acier, noir, cuivre

H 1100, Ø 430

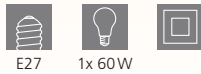

E27 1x 60W



9 002759 316662

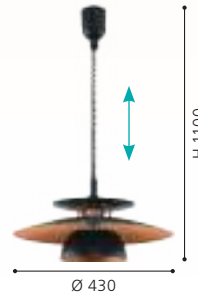

### 31666, 87055

This luminaires are flexible in height thanks to the spiral cables.

Diese Leuchten sind durch die Spiralkabel in der Höhe verstellbar.

La hauteur de ces lumières peut être ajustée à l'aide du câble en spirale.





**87054**

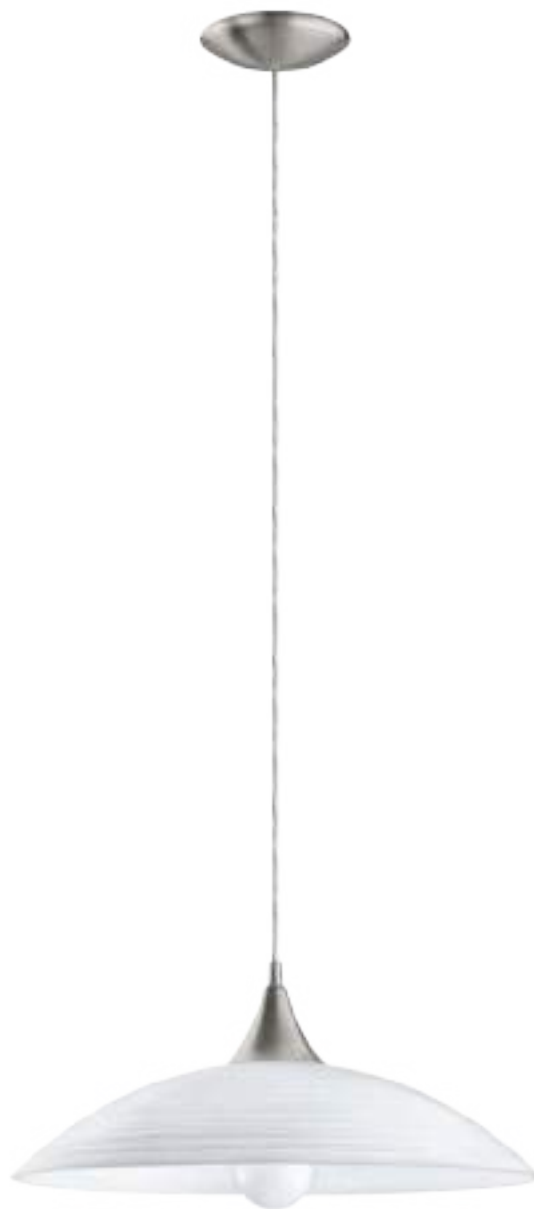

**91496**

### 87054 BRENDA

pendant light; steel, satin nickel / alabaster glass, white  
Hängeleuchte; Stahl, nickel-matt / Glas alabaster, weiss  
luminaire en suspension; acier, nickel mat / verre albâtre, blanc

H 1100, Ø 195



E27 1x 60W



9 002759 870546



### 91496 LAZOLO

pendant light; steel, satin nickel / satin glass, white painted  
Hängeleuchte; Stahl, nickel-matt / Glas satiniert, weiss lackiert  
luminaire en suspension; acier, nickel mat / verre satiné, blanc laqué

H 1100, Ø 420

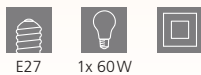

E27 1x 60W



9 002759 914967

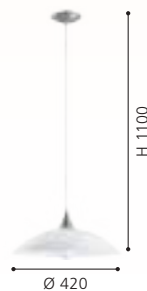

### 93468 MONTEFIO

pendant light; stainless steel, satin nickel / alabaster glass, white  
Hängeleuchte; Edelstahl, nickel-matt / Glas alabaster, weiss  
luminaire en suspension; acier inoxydable, nickel mat / verre albâtre, blanc

L 885, B 175, H 880 - 1300



3x 6,5W 2400lm



9 002759 934682

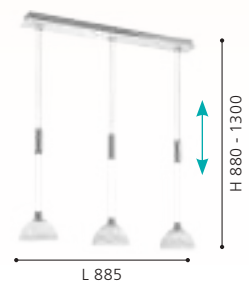



93468

LED



### 87008 LORD 2

pendant light; plastic, steel, grey, satin nickel / alabaster glass, white

Hängeleuchte; Kunststoff, Stahl, grau, nickel-matt / Glas alabaster, weiss

luminaire en suspension; plastique, acier, gris, nickel mat / verre albâtre, blanc

H 1100, Ø 360



E27

1x 60W

### 87009 LORD 2

pendant light; plastic, wood, silver, satin nickel, beech / alabaster glass, white

Hängeleuchte; Kunststoff, Holz, silber, nickel-matt, Buche / Glas alabaster, weiss

luminaire en suspension; plastique, bois, argent, nickel mat, hêtre / verre albâtre, blanc

H 1100, Ø 360



E27

1x 60W

### 3355, 87008, 87009



This luminaires are flexible in height thanks to the spiral cables.

Diese Leuchten sind durch die Spiralkabel in der Höhe verstellbar.

La hauteur de ces lumières peut être ajustée à l'aide du câble en spirale.



9 002759 870089

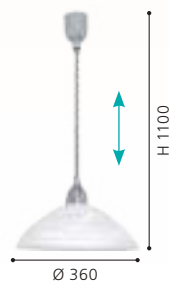

9 002759 870096

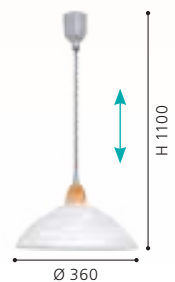



3355



90978



### 3355 ALESSANDRA

pendant light; plastic, white / alabaster glass, white  
 Hängeleuchte; Kunststoff, weiss / Glas alabaster, weiss  
 luminaire en suspension; plastique, blanc / verre albâtre, blanc

H 1100, Ø 380



E27 1x 60W

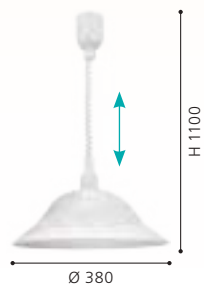

### 90978 ALBANY

pendant light; plastic, white / alabaster glass, white  
 Hängeleuchte; Kunststoff, weiss / Glas alabaster, weiss  
 luminaire en suspension; plastique, blanc / verre albâtre, blanc

H 1100, Ø 350



E27 1x 60W

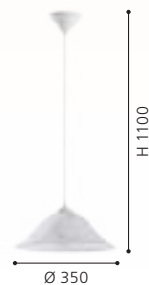

### 3355, 87008, 87009, 90978

These luminaires come with high quality processed alabaster glass.

Diese Leuchten sind mit hochwertigem Alabasterglas ausgestattet.

Ces luminaires viennent avec un abat-jour en verre d'albâtre haut de gamme.



3041

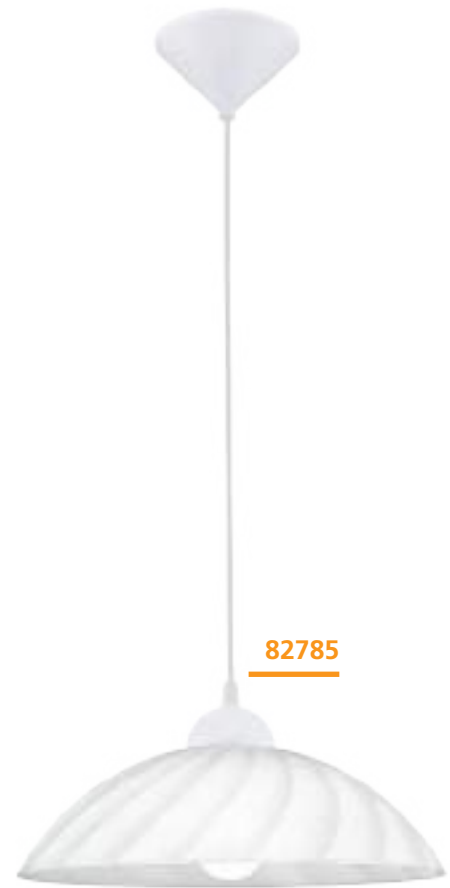

82785

### 3041 VETRO

pendant light; plastic, white / satin glass, white, purple, black  
Hängeleuchte; Kunststoff, weiss / Glas satiniert, weiss, lila, schwarz  
luminaire en suspension; plastique, blanc / verre satiné, blanc, violet, noir

H 1100, Ø 420



E27



1x 60W



9 002759 304102

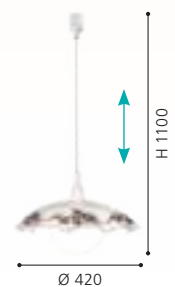





96474

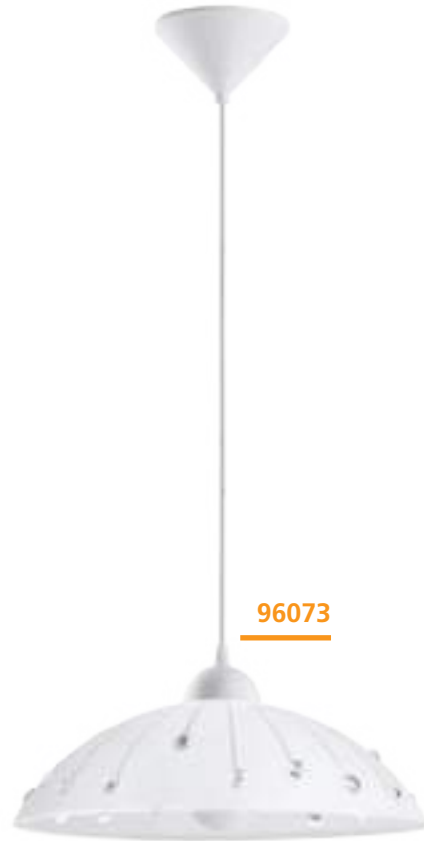

96073

### 3041, 96474

This luminaires are flexible in height thanks to the spiral cables.

Diese Leuchten sind durch die Spiralkabel in der Höhe verstellbar.

La hauteur de ces lumières peut être ajustée à l'aide du câble en spirale.



### 82785 VETRO

pendant light; plastic, white / satin glass, white  
Hängeleuchte; Kunststoff, weiss / Glas satiniert, weiss  
luminaire en suspension; plastique, blanc / verre satiné, blanc

H 1100, Ø 350



E27 1x 60W



9 002759 827854

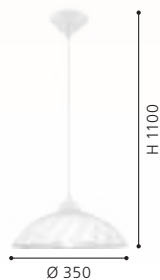

### 96474 ALVEZ

pendant light; plastic, white / structured glass, white, clear  
Hängeleuchte; Kunststoff, weiss / Glas mit Struktur, weiss, klar  
luminaire en suspension; plastique, blanc / verre avec structure, blanc, transparent

H 1100, Ø 420



E27 1x 60W



9 002759 964740



### 96073 VETRO

pendant light; plastic, white / satin glass, brilliant glass, white, clear  
Hängeleuchte; Kunststoff, weiss / Glas satiniert, Brillantglas, weiss, klar

luminaire en suspension; plastique, blanc / verre satiné, verre brillant, blanc, transparent

H 1100, Ø 350



E27 1x 60W



9 002759 960735





# WALL & CEILING LUMINAIRES

WAND- & DECKENLEUCHTEN  
APPLIQUES & PLAFONNIERS



**EN OUR ALL-ROUNDERS**

The range of wall and ceiling luminaires goes from simple to unusual designs. No matter if for the entrance area, hallway or your living rooms – these luminaires give the right light.

**DE UNSERE ALLROUNDER**

Das Sortiment an Wand- und Deckenleuchten reicht von schlichten bis hin zu ausgefallenen Designs. Egal ob für Eingangsbereich, Flur oder Ihre Wohnräume - diese Leuchten spenden das passende Licht.

**FR NOS PASSE-PARTOUT**





















La gamme d'éclairages muraux et de plafonds s'étend de designs simples à extraordinaires. Que ce soit pour l'entrée, le couloir ou vos espaces d'habitat - ces luminaires apportent la lumière appropriée.





# OVERVIEW

WALL & CEILING LUMINAIRES  
WAND- & DECKENLEUCHTEN  
APPLIQUES & PLAFONNIERS

 AMANDOLO 480-481	 RUOTALE 482	 ULISANO 482	 PADULARI 482	 ROLIMARE 483	 ALTAFLOR 484-486	 MONIROTE 485, 487	 GAFARES 488-489
 ZAMPOTE 490	 IPOLITTO 490	 TIRRENARA 492	 MARINELLO 1 492	 MARINELLO 493	 MIRLAS 494	 TAMURIA 496	 BORDONARA 498
 MARMORATA 499	 BOCADELLA 1 500	 TREMEDAL 501	 MESSINARO 502	 BELSIANA 502-503	 BELSIANA 1 503	 ENCINITOS 505	 MOGANO 3 505
 MONTEBALDO 506	 BARRANCAS 506	 MORDAZO 507	 STAITI 507	 SILENTINA 508-509	 MACCHIONE 509	 PIEDRITAS 510	 MOGANO 512-513
 MOGANO 2 514	 CENCIARA 515	 MOHARRAS 515	 DUAIA 516	 VALCASOTTO 1 517	 TARRAFO 517	 BASURTU 518	 LORETO 518-519
 LORETO 1 519	 FORCADET 519	 MARIEL 520	 MAROJALES 520	 FILAGO 521	 CONDRADE 1 522	 CABO 522	 ACOLLA 523
 CLEMENTE 523	 FRADELO 1 524-525	 FRADELO 526-527	 VALLEMARE 529	 SORRENTA 1 529	 CANICOSA 2 530	 MONTENOVO 531	 POZONDON 531



This product is available in different colors and shapes. / Dieser Artikel ist in unterschiedlichen Farben und Formen verfügbar. / Cet article est disponible en différentes couleurs et formes.

 GIRON 532	 GIRON-S 533	 FRANIA 534-535, 538-539	 FRANIA-S 536-537, 540-541	 SILERAS 541	 LANCIANO 1 542-543	 LANCIANO 542	 FERENTINO 544-545
 BATTISTONA 546	 BENARIBA 547	 COMPETA 1 548-549	 PALERMO 2 549	 CAPASSO 550	 RENDE 551	 NIEVES 1 552	 NIEVES 553
 PESCAITO 554	 MUSURITA 554-555	 LAURITO 556	 SELUCI 556-557	 VALCASOTTO 559	 LUPPINERIA 560-562	 PENJAMO 1 562	 PENJAMO 563
 CALAGRANO 564-565	 PALAGIANO 565	 PALAGIANO 1 566	 MENTALURGIA 567	 ELLA 568	 DURELO 569	 PLANET 570	 PLANET 1 570-573
 MARGITTA 1 575	 MARS 1 576-577	 MARS 577-578	 SALOME 578-579	 MAGITTA 1 580	 SCALEA 1 580	 GRAFIK 580	 NEMO 580
 MESTRE 582-583	 IMPERIAL 582	 ALMERA 583	 PASCAL 1 583	 CAMPANIA 584	 GERBERA 1 584	 COLTI 584	 SAN PERI 586
 STAITI 1 586	 TAZZOLI 589	 CIGLIE 589	 CARTIGNANO 590	 CIVITATE 591	 TIMPAROSSA 592	 ALAMILO 593	 GURARE 593



# OVERVIEW

WALL & CEILING LUMINAIRES  
WAND- & DECKENLEUCHTEN  
APPLIQUES & PLAFONNIERS



ZINACUA  
593



ZUBIALDE  
594



TUDONS  
595



ONO 2  
595



MACCACARI  
596



FELONICHE  
597



SANIA 4  
598-599



PASSA  
600-603



GASCUERIA  
604



ELIZONDO  
604



FALICETTO  
604



HAYES  
605



TANURA  
606



GUANAL  
606



CADEGAL  
608-609



REMIDOS  
609



METRASS  
610



METRASS 2  
611



METRASS 1  
613



SARGINTO  
614-615



This product is available in different colors and shapes. / Dieser Artikel ist in unterschiedlichen Farben und Formen verfügbar. / Cet article est disponible en différentes couleurs et formes.

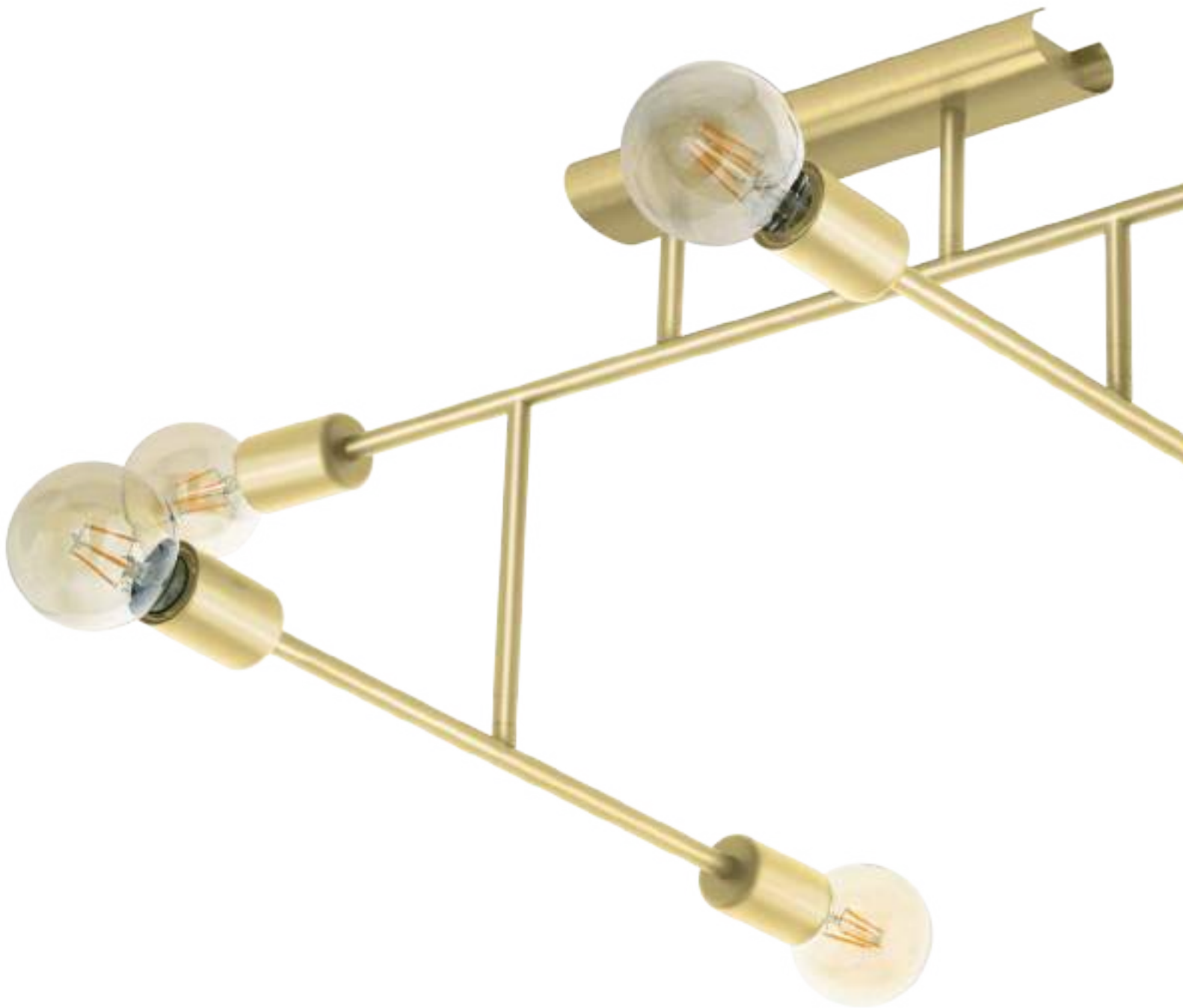

# FUNCTIONAL OVERVIEW

## FUNKTIONSÜBERSICHT

## PRÉSENTATION FONCTIONNELLE

The listed boxes inform you about the respective functions of our wall and ceiling luminaires. You will find them on the catalogue pages next to the product illustrations. The coloured symbol area indicates the special characteristics of the respective luminaire/luminaire family, e.g. dimming function. In the grey area below you will find detailed information on this function, e.g. dimmable from 10% - 100%.

For luminaires that come with a remote control, you can control the respective functions with the remote control. For luminaires without remote control, the functions can be switched directly on the wall switch.

Die angeführten Boxen informieren Sie über die jeweiligen Funktionen unserer Wand- und Deckenleuchten. Sie finden sie auf den Katalogseiten jeweils neben den Produktabbildungen. Der farbige Symbolbereich weist darauf hin, welche besonderen Eigenschaften die jeweilige Leuchte/Leuchtenfamilie bietet, z.B. Dimmfunktion. Im grauen Bereich darunter finden Sie detaillierte Angaben zu dieser Funktion, z.B. dimmbar von 10% - 100%.

Ist eine Fernbedienung im Lieferumfang enthalten, können Sie die jeweiligen Funktionen mit der Fernbedienung steuern. Bei Leuchten ohne Fernbedienung können die Funktionen direkt am Wandschalter geschaltet werden.

Les boîtes de dialogue présentes vous informent sur les fonctions respectives de nos appliques et plafonniers. Vous les trouverez sur les pages du catalogue à côté des illustrations des produits. La zone colorée des symboles indique les caractéristiques particulières de chaque luminaire/famille de luminaires, par ex. la fonction de gradation. Dans la zone grise ci-dessous, vous trouverez des informations détaillées sur cette fonction, par ex. graduable de 10% - 100%.

Pour les luminaires équipés d'une télécommande, vous pouvez commander les fonctions correspondantes à l'aide de la télécommande. Pour les luminaires sans télécommande, les fonctions peuvent être commutées directement sur l'interrupteur mural.



**DIMMABLE**

e.g./z.B./par ex.  
10 - 100%

The brightness of the luminaire can be steplessly controlled.

Die Helligkeit der Leuchte kann stufenlos im angegebenen Bereich gesteuert werden.

La luminosité du luminaire peut être réglée en continu.



**STEP DIMMING**

e.g./z.B./par ex.  
10%/50%/100%

The brightness of the luminaire can be controlled step by step.

Die Helligkeit der Leuchte kann schrittweise gesteuert werden.

La luminosité du luminaire peut être réglée pas à pas.



**TUNABLE WHITE**

e.g./z.B./par ex.  
2700 - 6500 K

The colour temperature can be controlled from warm to cold white LED light.

Die Farbtemperatur kann von warm- bis kaltweißem LED-Licht gesteuert werden.

La température de couleur peut être réglée de la lumière DEL blanche chaude à la lumière DEL blanche froide.



**STEP TUNABLE**

e.g./z.B./par ex.  
3000/4000/5000 K

The colour temperature of warm to cold white LED light can be changed directly on the wall switch in 3 preset steps.

Die Farbtemperatur von warm- bis kaltweißem LED-Licht kann direkt am Wandschalter in 3 voreingestellten Schritten verändert werden.

La température de couleur peut être modifiée de la lumière DEL blanche chaude à la lumière DEL blanche froide directement sur l'interrupteur mural en 3 étapes prédéfinies.



**NIGHT LIGHT FUNCTION**

Luminaires can be switched to a night light mode. With included remote control or, for luminaires without remote control, via wall switch (ambient light).

Leuchten können auf einen Nacht-Licht-Modus umgeschaltet werden. Mit inkludierter Fernbedienung oder bei Leuchten ohne Fernbedienung per Wandschalter (Ambient light).

Les luminaires peuvent être commutés en mode veilleuse. Avec télécommande incluse ou, pour les luminaires sans télécommande, via interrupteur mural (lumière ambiante).



**TIMER FUNCTION**

e.g./z.B./par ex.  
off after 30 sec.

The luminaire switches itself off after a preset time.

Die Leuchte schaltet sich nach einer voreingestellten Zeit selbst aus.

La lumière s'éteint d'elle-même après une durée prédéfinie.





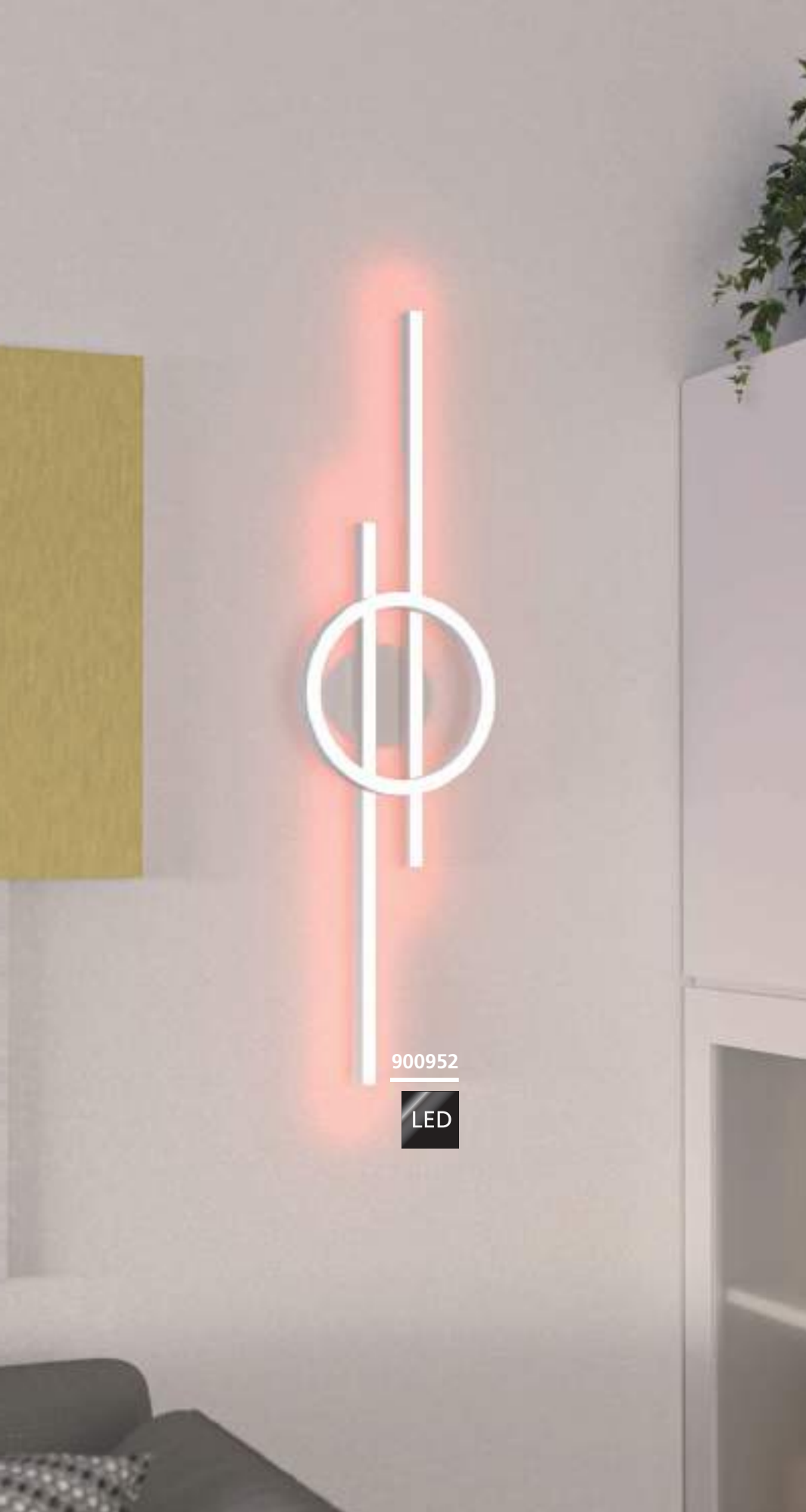

900952



## REMOTE+

Our new 2.4 GHz REMOTE+ makes it easier than ever to control your lights. With its user-friendly design and simple control, you can easily adjust your luminaire to create the perfect ambiance for any occasion:

- › Stepless Dimming
- › Quick Pairing
- › Timer Function
- › Stepless Tunable White
- › Memory Effect
- › Control up to 10 REMOTE+ luminaires

Unsere neue 2,4-GHz REMOTE+ macht die Steuerung Ihrer Leuchten so einfach wie nie zuvor. Mit ihrem benutzerfreundlichen Design und der einfachen Steuerung können Sie Ihre Leuchte ganz einfach einstellen, um das perfekte Ambiente für jede Gelegenheit zu schaffen:

- › Stufenloses Dimmen
- › Schnelle Kopplung
- › Timer-Funktion
- › Stufenlos einstellbares Weiß
- › Memory-Effekt
- › Steuerung von bis zu 10 REMOTE+-Leuchten

Notre nouvelle REMOTE+ 2,4 GHz facilite plus que jamais le contrôle de vos lumières. Grâce à sa conception conviviale et à sa commande simple, vous pouvez facilement régler votre luminaire pour créer l'ambiance parfaite en toute occasion:

- › Gradation progressive
- › appairage rapide
- › Fonction de minuterie
- › Blanc réglable en continu
- › Effet de mémoire
- › Contrôle jusqu'à 10 luminaires REMOTE

## 900952 AMANDOLO

ceiling light; aluminium, steel, white / plastic, white  
 Deckenleuchte; Alu, Stahl, weiss / Kunststoff, weiss  
 plafonnier; aluminium, acier, blanc / plastique, blanc

L 775, B 200, H 75



23,5W



2850lm



CR2032



9 008606 275045

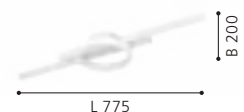



900953



900955



900954



### 900953 AMANDOLO

ceiling light; aluminium, steel, black / plastic, white  
Deckenleuchte; Alu, Stahl, schwarz / Kunststoff, weiss  
plafonnier; aluminium, acier, noir / plastique, blanc

L 775, B 200, H 75



23,5W 2850lm CR2032

### 900954 AMANDOLO

ceiling light; aluminium, steel, white / plastic, white  
Deckenleuchte; Alu, Stahl, weiss / Kunststoff, weiss  
plafonnier; aluminium, acier, blanc / plastique, blanc

L 675, B 380, H 65



19,5W 2400lm CR2032

### 900955 AMANDOLO

ceiling light; aluminium, steel, black / plastic, white  
Deckenleuchte; Alu, Stahl, schwarz / Kunststoff, weiss  
plafonnier; aluminium, acier, noir / plastique, blanc

L 675, B 380, H 65



19,5W 2400lm CR2032



9 008606 275052



9 008606 275069

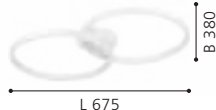

9 008606 275076





900471



900596



900597



### 900471 RUOTALE

ceiling light; aluminium, steel, black / plastic, white  
Deckenleuchte; Alu, Stahl, schwarz / Kunststoff, weiss  
plafonnier; aluminium, acier, noir / plastique, blanc

H 55, Ø 450



### 900596 ULISANO

ceiling light; aluminium, steel, black / plastic, white  
Deckenleuchte; Alu, Stahl, schwarz / Kunststoff, weiss  
plafonnier; aluminium, acier, noir / plastique, blanc

L 420, B 420, H 55



### 900597 PADULARI

ceiling light; aluminium, steel, black / plastic, white  
Deckenleuchte; Alu, Stahl, schwarz / Kunststoff, weiss  
plafonnier; aluminium, acier, noir / plastique, blanc

L 535, B 470, H 50

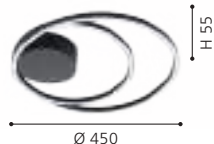



99395

LED



900419

LED



### 900419 ROLIMARE

ceiling light; aluminium, satin nickel / plastic, white  
Deckenleuchte; Alu, nickel-matt / Kunststoff, weiss  
plafonnier; aluminium, nickel mat / plastique, blanc

L 420, B 400, H 130



35W 5500lm

### 99395 ROLIMARE

ceiling light; aluminium, black / plastic, white  
Deckenleuchte; Alu, schwarz / Kunststoff, weiss  
plafonnier; aluminium, noir / plastique, blanc

L 420, B 400, H 130



35W 5500lm



9 008606 240999



9 002759 993955





99788

LED

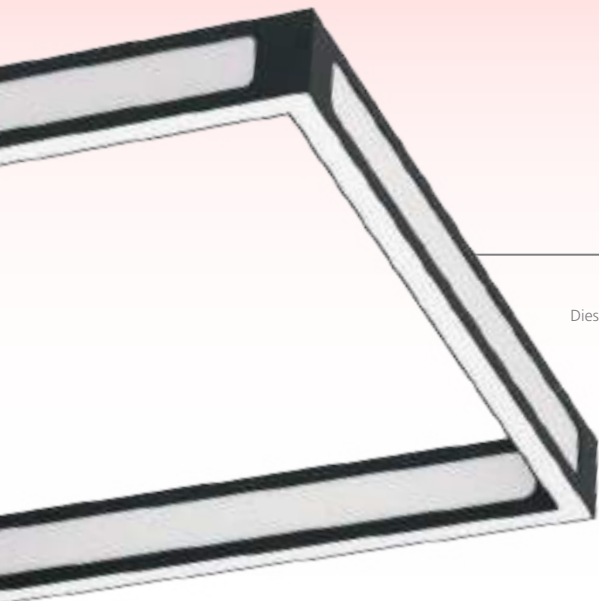

#### ALTAFLOR

These luminaires have an additional glow on the inside.  
Diese Leuchten haben einen zusätzlichen Lichtschein nach Innen.  
Ces luminaires ont une lueur supplémentaire à l'intérieur.

#### 99788 ALTAFLOR

ceiling light; steel, black / plastic, white  
Deckenleuchte; Stahl, schwarz / Kunststoff, weiss  
plafonnier; acier, noir / plastique, blanc

L 650, B 300, H 70

LED

warm  
WHITE



8x 2,8W 3040lm



9 002759 997885

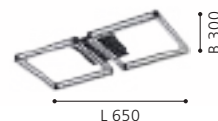



99787



99789

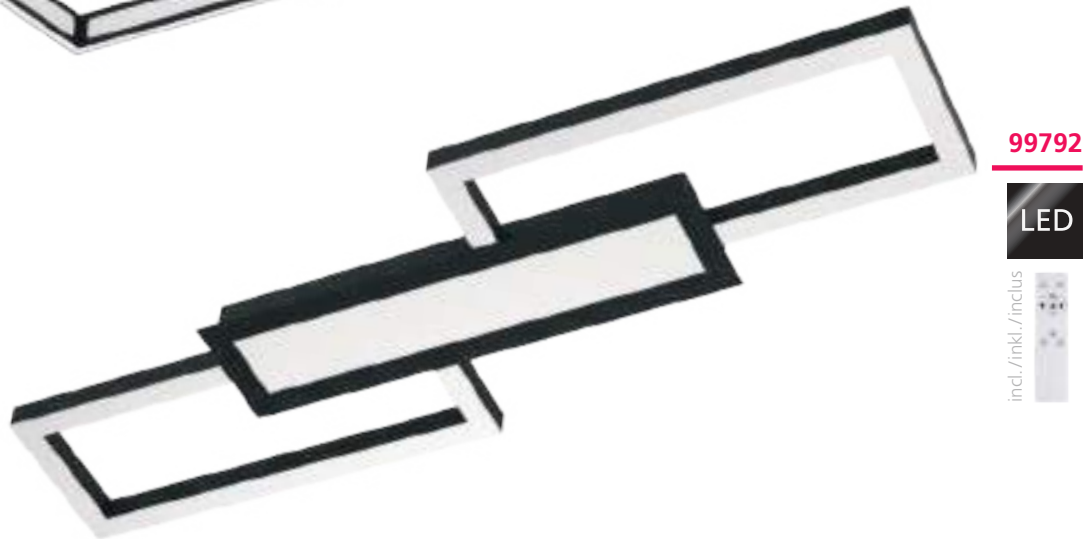

99792



incl./mkl./inclus  

### 99787 ALTAFLOR

ceiling light; steel, black / plastic, white  
 Deckenleuchte; Stahl, schwarz / Kunststoff, weiss  
 plafonnier; acier, noir / plastique, blanc

L 315, B 315, H 70



4x 2,8W 1520lm

### 99789 ALTAFLOR

ceiling light; steel, black / plastic, white  
 Deckenleuchte; Stahl, schwarz / Kunststoff, weiss  
 plafonnier; acier, noir / plastique, blanc

L 1000, B 315, H 70



12x 2,8W 4560lm

### 99792 MONIROTE

ceiling light; steel, aluminium, black / plastic, white  
 Deckenleuchte; Stahl, Alu, schwarz / Kunststoff, weiss  
 plafonnier; acier, aluminium, noir / plastique, blanc

L 780, B 260, H 45



37W 4450lm

Remote



9 002759 997878



9 002759 997892

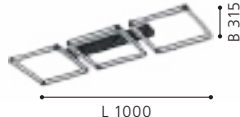

9 002759 997922

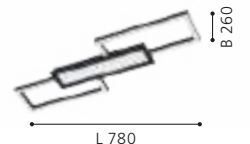



99784



99785



99786



### 99784 ALTAFLOR

ceiling light; steel, satin nickel / plastic, white  
Deckenleuchte; Stahl, nickel-matt / Kunststoff, weiss  
plafonnier; acier, nickel mat / plastique, blanc

L 315, B 315, H 70



4x 2,8W 1520lm

### 99785 ALTAFLOR

ceiling light; steel, satin nickel / plastic, white  
Deckenleuchte; Stahl, nickel-matt / Kunststoff, weiss  
plafonnier; acier, nickel mat / plastique, blanc

L 650, B 300, H 70



8x 2,8W 3040lm

### 99786 ALTAFLOR

ceiling light; steel, satin nickel / plastic, white  
Deckenleuchte; Stahl, nickel-matt / Kunststoff, weiss  
plafonnier; acier, nickel mat / plastique, blanc

L 1000, B 315, H 70



12x 2,8W 4560lm



9 002759 997847



9 002759 997854

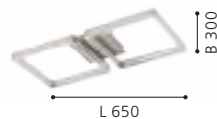

9 002759 997861

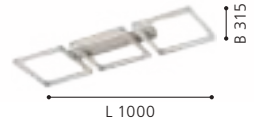





99791

LED

incl./inkl./inclus



### 99791 MONIROTE

ceiling light; steel, aluminium, satin nickel / plastic, white  
 Deckenleuchte; Stahl, Alu, nickel-matt / Kunststoff, weiss  
 plafonnier; acier, aluminium, nickel mat / plastique, blanc

L 780, B 260, H 45



37W



4450lm



Remote



### ALTAFLOR

These luminaires have an additional glow on the inside.  
 Diese Leuchten haben einen zusätzlichen Lichtschein nach Innen.  
 Ces luminaires ont une lueur supplémentaire à l'intérieur.



9 002759 997915





900421

LED

incl./inkl./inclus



DESIGN  
HIGHLIGHT  
DETAIL

### 900421 GAFARES

ceiling light; aluminium, steel, black, white / plastic, white  
Deckenleuchte; Alu, Stahl, schwarz, weiss / Kunststoff, weiss  
plafonnier; aluminium, acier, noir, blanc / plastique, blanc

L 405, B 290, H 55

LED

15W

tunable  
WHITE

2100lm



CONTROL  
UNIT

Remote



9 008606 241002



L 405

B 290



**900422**

LED

incl./inkl./inclus



**900424**

LED

incl./inkl./inclus



**900423**

LED

incl./inkl./inclus



### 900422 GAFARES

ceiling light; aluminium, steel, black, white / plastic, white  
Deckenleuchte; Alu, Stahl, schwarz, weiss / Kunststoff, weiss  
plafonnier; aluminium, acier, noir, blanc / plastique, blanc

L 330, B 330, H 50



15W

2100lm

Remote

### 900423 GAFARES

ceiling light; aluminium, steel, gold, white / plastic, white  
Deckenleuchte; Alu, Stahl, gold, weiss / Kunststoff, weiss  
plafonnier; aluminium, acier, or, blanc / plastique, blanc

L 405, B 290, H 55



15W

2100lm

Remote

### 900424 GAFARES

ceiling light; aluminium, steel, gold, white / plastic, white  
Deckenleuchte; Alu, Stahl, gold, weiss / Kunststoff, weiss  
plafonnier; aluminium, acier, or, blanc / plastique, blanc

L 330, B 330, H 50



15W

2100lm

Remote



9 008606 241026



L 330

B 330



9 008606 241019



L 405

B 290



9 008606 241033



L 330

B 330



900329



900328



### 900329 ZAMPOTE

ceiling light; aluminium, steel, white, black / plastic, white  
Deckenleuchte; Alu, Stahl, weiss, schwarz / Kunststoff, weiss  
plafonnier; aluminium, acier, blanc, noir / plastique, blanc

L 380, B 380, H 50



### 900328 ZAMPOTE

ceiling light; aluminium, steel, white, black / plastic, white  
Deckenleuchte; Alu, Stahl, weiss, schwarz / Kunststoff, weiss  
plafonnier; aluminium, acier, blanc, noir / plastique, blanc

H 50, Ø 420



### 99817 IPOLITTO

ceiling light; aluminium, steel, black / plastic, white  
Deckenleuchte; Alu, Stahl, schwarz / Kunststoff, weiss  
plafonnier; aluminium, acier, noir / plastique, blanc

L 995, B 165, H 245



9 008606 238101

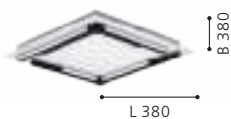

9 008606 238095



9 002759 998172

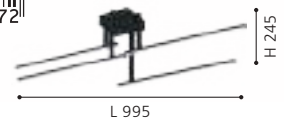



99817

LED



900603



900604



99793



### 900603 TIRRENARA

ceiling light; steel, wood, black, brown / plastic, white  
Deckenleuchte; Stahl, Holz, schwarz, braun / Kunststoff, weiss  
plafonnier; acier, bois, noir, marron / plastique, blanc

L 370, B 370, H 55



4x 5,4W 2600lm

Remote

### 900604 TIRRENARA

ceiling light; steel, wood, black, brown / plastic, white  
Deckenleuchte; Stahl, Holz, schwarz, braun / Kunststoff, weiss  
plafonnier; acier, bois, noir, marron / plastique, blanc

L 780, B 305, H 55



2x 9,2W 3960lm 1x 13,7W

Remote

### 99793 MARINELLO 1

ceiling light; aluminium, steel, wood, black, brown / plastic, white  
Deckenleuchte; Alu, Stahl, Holz, schwarz, braun / Kunststoff, weiss  
plafonnier; aluminium, acier, bois, noir, marron / plastique, blanc

L 500, B 500, H 90



4x 5,3W 2800lm



9 008606 245017

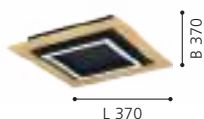

9 008606 245024

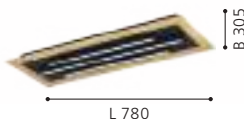

9 002759 997939

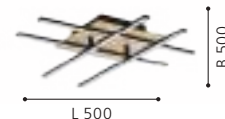



99659

LED

incl./inkl./inclus 

### 99659 MARINELLO

ceiling light; aluminium, steel, wood, black, brown / plastic, white

Deckenleuchte; Alu, Stahl, Holz, schwarz, braun / Kunststoff, weiss

plafonnier; aluminium, acier, bois, noir, marron / plastique, blanc

L 485, B 485, H 55

 LED	 tunable WHITE	 LED	 tunable WHITE	
2x 17W	4400lm	4,2W	590lm	

 CONTROL  
UNIT



Remote

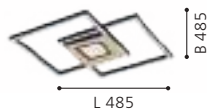



98861



MIRLAS



98862



### 98861 MIRLAS

ceiling light; wood, steel, brown / plastic, white  
Deckenleuchte; Holz, Stahl, braun / Kunststoff, weiss  
plafonnier; bois, acier, marron / plastique, blanc

L 360, B 210, H 90



E27



2x 9W

### 98862 MIRLAS

ceiling light; wood, steel, brown / plastic, white  
Deckenleuchte; Holz, Stahl, braun / Kunststoff, weiss  
plafonnier; bois, acier, marron / plastique, blanc

L 690, B 270, H 90



E27



4x 9W

### 98863 MIRLAS

ceiling light; wood, steel, brown / plastic, white  
Deckenleuchte; Holz, Stahl, braun / Kunststoff, weiss  
plafonnier; bois, acier, marron / plastique, blanc

L 540, B 520, H 90



E27



6x 9W



9 002759 988616

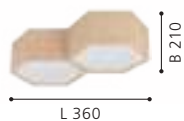

9 002759 988623

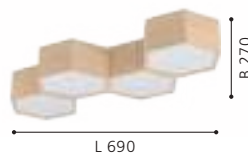

9 002759 988630

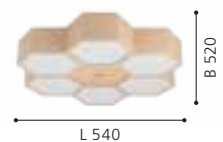





98863



99656

LED



### TAMURIA

This luminaires have rotatable panels in wood look and black.

Diese Artikel verfügen über Platten in Holzoptik und schwarz zum Wechseln.

Ces luminaires a des panneaux en bois optique et noir à changer.

#### 99656 TAMURIA

ceiling light; steel, wood, black, brown / plastic, white  
Deckenleuchte; Stahl, Holz, schwarz, braun / Kunststoff, weiss  
plafonnier; acier, bois, noir, marron / plastique, blanc

L 435, B 435, H 70



21W 2700lm

#### 99655 TAMURIA

ceiling light; steel, wood, black, brown / plastic, white  
Deckenleuchte; Stahl, Holz, schwarz, braun / Kunststoff, weiss  
plafonnier; acier, bois, noir, marron / plastique, blanc

L 285, B 285, H 60



10,8W 1300lm





99655

LED



900573



900571



900572



### 900573 BORDONARA

ceiling light; aluminium, steel, black, white / plastic, white  
Deckenleuchte; Alu, Stahl, schwarz, weiss / Kunststoff, weiss  
plafonnier; aluminium, acier, noir, blanc / plastique, blanc

L 1195, B 295



35W



5400lm



Remote



9 008606 244744

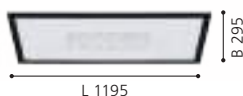

### 900571 BORDONARA

ceiling light; aluminium, steel, black, white / plastic, white  
Deckenleuchte; Alu, Stahl, schwarz, weiss / Kunststoff, weiss  
plafonnier; aluminium, acier, noir, blanc / plastique, blanc

L 450, B 450



21,5W



2800lm



Remote



9 008606 244720



### 900572 BORDONARA

ceiling light; aluminium, steel, black, white / plastic, white  
Deckenleuchte; Alu, Stahl, schwarz, weiss / Kunststoff, weiss  
plafonnier; aluminium, acier, noir, blanc / plastique, blanc

L 595, B 595



36W



4900lm



Remote



9 008606 244737





900559



900561



900558



### 900559 MARMORATA

ceiling light; aluminium, steel, black, white / plastic, white  
Deckenleuchte; Alu, Stahl, schwarz, weiss / Kunststoff, weiss  
plafonnier; aluminium, acier, noir, blanc / plastique, blanc

L 445, B 445



### 900561 MARMORATA

ceiling light; aluminium, steel, black, white / plastic, white  
Deckenleuchte; Alu, Stahl, schwarz, weiss / Kunststoff, weiss  
plafonnier; aluminium, acier, noir, blanc / plastique, blanc

L 595, B 295

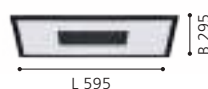

### 900558 MARMORATA

ceiling light; aluminium, steel, black, white / plastic, white  
Deckenleuchte; Alu, Stahl, schwarz, weiss / Kunststoff, weiss  
plafonnier; aluminium, acier, noir, blanc / plastique, blanc

H 70, Ø 450





**98319**



**98317**



**98318**

### 98319 BOCADELLA 1

ceiling light; steel, black  
Deckenleuchte; Stahl, schwarz  
plafonnier; acier, noir

H 360, Ø 920



E27 12x 60W



9 002759 983192

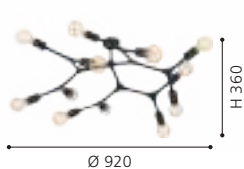

Ø 920

### 98317 BOCADELLA 1

ceiling light; steel, black  
Deckenleuchte; Stahl, schwarz  
plafonnier; acier, noir

H 215, Ø 345



E27 3x 60W



9 002759 983178

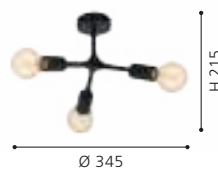

Ø 345

### 98318 BOCADELLA 1

ceiling light; steel, black  
Deckenleuchte; Stahl, schwarz  
plafonnier; acier, noir

H 365, Ø 640



E27 9x 60W



9 002759 983185

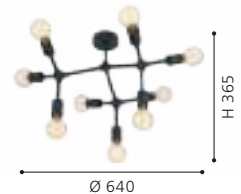

Ø 640



98507

### 98507 TREMEDAL

ceiling light; steel, black  
Deckenleuchte; Stahl, schwarz  
plafonnier; acier, noir

H 215, Ø 560



E27



1x 28W

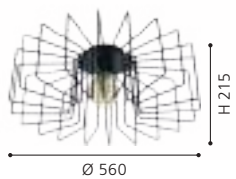



**900367**



**98034**

**900367 MESSINARO**

ceiling light; steel, black, brushed brass  
 Deckenleuchte; Stahl, schwarz, messing-gebürstet  
 plafonnier; acier, noir, laiton brossé

L 720, B 280, H 115



E27



3x 40W

**98034 BELSIANA**

ceiling light; steel, black  
 Deckenleuchte; Stahl, schwarz  
 plafonnier; acier, noir

L 890, B 510, H 350



E27



6x 40W



9 008606 243525



9 002759 980344

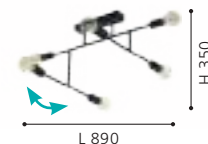





**98035**

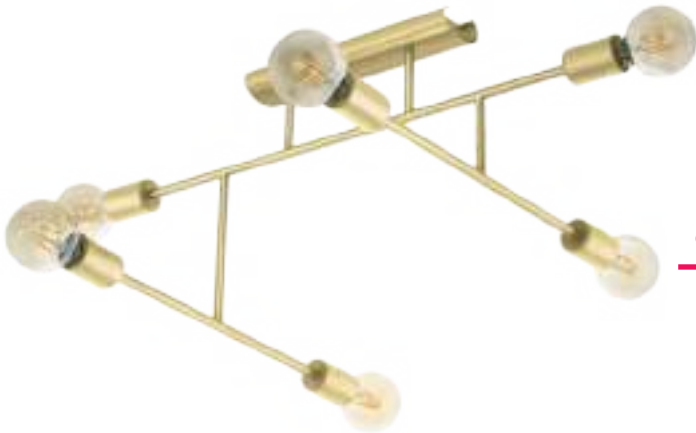

**98881**



**98882**

### 98035 BELSIANA

ceiling light; steel, black  
Deckenleuchte; Stahl, schwarz  
plafonnier; acier, noir

L 1180, B 510, H 350



E27 8x 40W



9 002759 980351

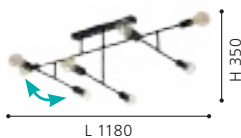

### 98881 BELSIANA 1

ceiling light; steel, brushed brass  
Deckenleuchte; Stahl, messing-gebürstet  
plafonnier; acier, laiton brossé

L 1155, B 510, H 455



E27 6x 40W



9 002759 988814

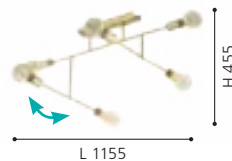

### 98882 BELSIANA 1

ceiling light; steel, brushed brass  
Deckenleuchte; Stahl, messing-gebürstet  
plafonnier; acier, laiton brossé

L 1180, B 510, H 350



E27 8x 40W



9 002759 988821

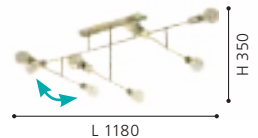



99664





**900721**



MOGANO 3



**900792**

### 99664 ENCINITOS

ceiling light; steel, black, gold  
Deckenleuchte; Stahl, schwarz, gold  
plafonnier; acier, noir, or

H 260, Ø 450



E27 1x 40W



9 002759 996642

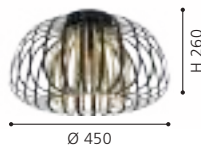

### 900721 MOGANO 3

ceiling light; steel, black  
Deckenleuchte; Stahl, schwarz  
plafonnier; acier, noir

H 180, Ø 430



E27 1x 40W



9 008606 254309

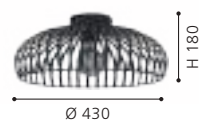

### 900792 MOGANO 3

ceiling light; steel, black  
Deckenleuchte; Stahl, schwarz  
plafonnier; acier, noir

H 180, Ø 280



E27 1x 40W



9 008606 254217

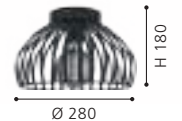

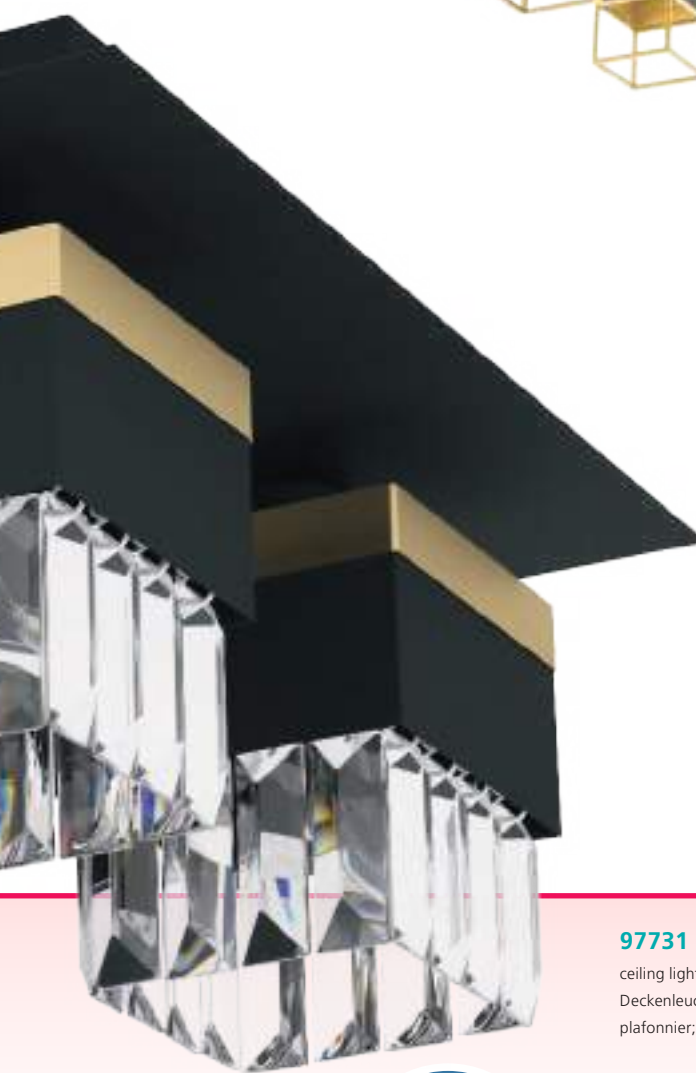

97731

LED



900302

DESIGN  
HIGHLIGHT  
DETAIL

**97731 MONTEBALDO**

ceiling light; steel, black, gold  
Deckenleuchte; Stahl, schwarz, gold  
plafonnier; acier, noir, or

L 380, B 380, H 170



GU10



4x 4,5W



warm  
WHITE

4x

345lm

**900302 BARRANCAS**

ceiling light; steel, black, gold / brilliant glass, clear  
Deckenleuchte; Stahl, schwarz, gold / Brillantglas, klar  
plafonnier; acier, noir, or / verre brillant, transparent

L 380, B 380, H 180



E14



4x 40W



9 002759 977313

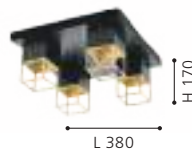

9 008606 242764

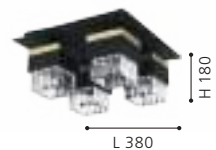



**900524**



**97904**



**97895**

### 900524 MORDAZO

ceiling light; steel, black / fabric, wood, anthracite-brown, white  
Deckenleuchte; Stahl, schwarz / Textil, Holz, anthrazit-braun, weiss  
plafonnier; acier, noir / tissu, bois, marron anthracite, blanc

L 510, B 510, H 175



E27 4x 28W

### 97904 STAITI

ceiling light; steel, black  
Deckenleuchte; Stahl, schwarz  
plafonnier; acier, noir

H 140, Ø 760



E27 7x 60W

### 97895 STAITI

ceiling light; steel, black / fabric, black, gold  
Deckenleuchte; Stahl, schwarz / Textil, schwarz, gold  
plafonnier; acier, noir / tissu, noir, or

H 235, Ø 840



E27 7x 40W



9 008606 244522

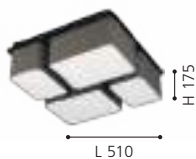

9 002759 979041

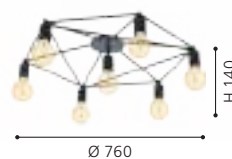

9 002759 978952

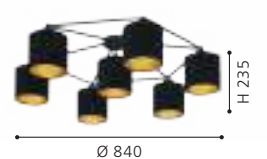



**98333**



**98331**



**98332**

**98333 SILENTINA**

ceiling light; steel, black  
Deckenleuchte; Stahl, schwarz  
plafonnier; acier, noir

L 540, B 180, H 205



E27



3x 40W



9 002759 983338

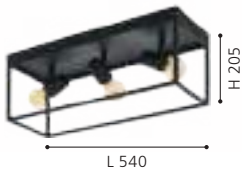

**98331 SILENTINA**

ceiling light; steel, black  
Deckenleuchte; Stahl, schwarz  
plafonnier; acier, noir

L 180, B 180, H 205



E27



1x 40W



9 002759 983314

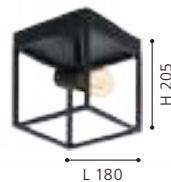

**98332 SILENTINA**

ceiling light; steel, black  
Deckenleuchte; Stahl, schwarz  
plafonnier; acier, noir

L 360, B 180, H 205



E27



2x 40W



9 002759 983321





98334



900509

### 98334 SILENTINA

ceiling light; steel, black  
Deckenleuchte; Stahl, schwarz  
plafonnier; acier, noir

L 360, B 360, H 205



9 002759 983345

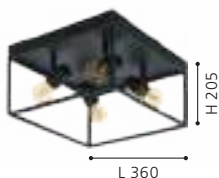

### 900509 MACCHIONE

wall light; steel, black, brass  
Wandleuchte; Stahl, schwarz, messing  
Applique; acier, noir, laiton

L 500, H 110, A 85



9 008606 244393

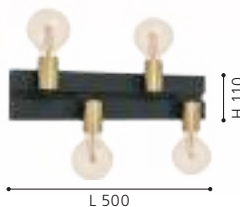

### 900509

Sockets are individually alignable for the customer with the help of a magnet. The luminaires work both as a wall luminaire, and as a ceiling luminaire.

Fassungen sind mithilfe eines Magnets für den Kunden individuell ausrichtbar. Die Leuchten funktionieren sowohl als Wandleuchte, als auch als Deckenleuchte.

Les douilles peuvent être orientées individuellement par le client à l'aide d'un aimant. Les luminaires fonctionnent aussi bien comme appliques murales que comme plafonniers.





**900357**



**900356**

**900357 PIEDRITAS**

ceiling light; steel, black  
Deckenleuchte; Stahl, schwarz  
plafonnier; acier, noir

L 730, B 180, H 205



E27



3x 40W

**900356 PIEDRITAS**

ceiling light; steel, black  
Deckenleuchte; Stahl, schwarz  
plafonnier; acier, noir

L 515, B 180, H 205



E27



2x 40W

**900355 PIEDRITAS**

ceiling light; steel, black  
Deckenleuchte; Stahl, schwarz  
plafonnier; acier, noir

L 180, B 180, H 205



E27



1x 40W



9 008606 235728

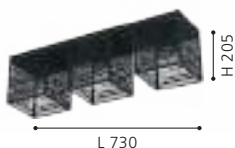

L 730



9 008606 235711

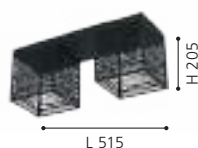

L 515



9 008606 235704

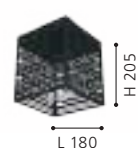

L 180





900355





**94547**



**94548**



**900359**

### 94547 MOGANO

ceiling light; steel, black, copper  
Deckenleuchte; Stahl, schwarz, kupfer  
plafonnier; acier, noir, cuivre

H 170, Ø 400



E27 1x 60W



9 002759 945473



### 94548 MOGANO

ceiling light; steel, white, silver  
Deckenleuchte; Stahl, weiss, silber  
plafonnier; acier, blanc, argent

H 170, Ø 400



E27 1x 60W



9 002759 945480



### 900359 MOGANO

ceiling light; steel, mocha-coloured  
Deckenleuchte; Stahl, Mokkafarben  
plafonnier; acier, café

H 175, Ø 400



E27 1x 60W



9 008606 235315





**43637**

**43637 MOGANO**

ceiling light; steel, black  
Deckenleuchte; Stahl, schwarz  
plafonnier; acier, noir

H 170, Ø 400



E27



1x 60W





900553



900554



900555

### 900553 MOGANO 2

ceiling light; steel, black  
Deckenleuchte; Stahl, schwarz  
plafonnier; acier, noir

H 175, Ø 280



E27



1x 40W

### 900554 MOGANO 2

ceiling light; steel, black, gold  
Deckenleuchte; Stahl, schwarz, gold  
plafonnier; acier, noir, or

H 175, Ø 280



E27



1x 40W

### 900555 MOGANO 2

ceiling light; steel, black, copper  
Deckenleuchte; Stahl, schwarz, kupfer  
plafonnier; acier, noir, cuivre

H 175, Ø 280



E27



1x 40W



9 008606 244584



9 008606 244591



9 008606 244607





**900848**



**900736**



**900848 CENCIARA**

ceiling light; steel, black / steel, brushed brass, gold  
 Deckenleuchte; Stahl, schwarz / Stahl, messing-gebürstet, gold  
 plafonnier; acier, noir / acier, laiton brossé, or

H 180, Ø 400



E27 1x 40W

**900736 MOHARRAS**

ceiling light; wood, brown / steel, sandy  
 Deckenleuchte; Holz, braun / Stahl, sandfarben  
 plafonnier; bois, marron / acier, couleur sable

H 160, Ø 400



E27 1x 40W

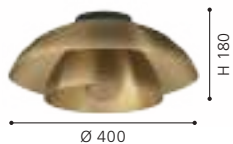

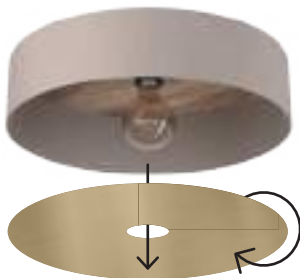

## DUAIA

The look of these luminaires can be changed very easily thanks to the reversible plate. Front: wood look / back: brushed brass

Die Optik dieser Leuchten lässt sich durch die umkehrbare Platte ganz einfach verändern. Vorderseite: holzoptik / Rückseite: messing gebürstet

L'aspect de ces luminaires peut être facilement modifié grâce à la plaque réversible. face avant : aspect bois / face arrière : laiton brossé



**900837**



**900838**



### 900837 DUAIA

ceiling light; steel, umbra grey / wood, steel, brown, brushed brass

Deckenleuchte; Stahl, Umbragrau / Holz, Stahl, braun, messing-gebürstet

plafonnier; acier, Gris ombre / bois, acier, marron, laiton brossé

H 160, Ø 420



E27 1x 40W

### 900838 DUAIA

ceiling light; steel, taupe structure / wood, steel, brown, brushed brass

Deckenleuchte; Stahl, taupe-struktur / Holz, Stahl, braun, messing-gebürstet

plafonnier; acier, taupe structuré / bois, acier, marron, laiton brossé

H 160, Ø 420



E27 1x 40W



9 008606 269129



9 008606 269136





900435

LED



900443



### 900435 VALCASOTTO 1

ceiling light; steel, wood, black, brown  
 Deckenleuchte; Stahl, Holz, schwarz, braun  
 plafonnier; acier, bois, noir, marron

L 370, B 370, H 100



GU10



4x 4,5W



warm  
WHITE

4x

345lm

### 900443 TARRAFO

ceiling light; steel, wood, black, brown  
 Deckenleuchte; Stahl, Holz, schwarz, braun  
 plafonnier; acier, bois, noir, marron

L 640, B 150, H 155



E27



3x 40W



9 008606 240586



9 008606 243945





**99667**



**900188**

DESIGN  
HIGHLIGHT  
DETAIL



**99667 BASURTU**

ceiling light; steel, black  
Deckenleuchte; Stahl, schwarz  
plafonnier; acier, noir

H 270, Ø 1050



9 002759 996673

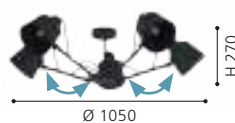

**900188 LORETO**

ceiling light; steel, black, white  
Deckenleuchte; Stahl, schwarz, weiss  
plafonnier; acier, noir, blanc

H 355, Ø 1145



9 008606 235629

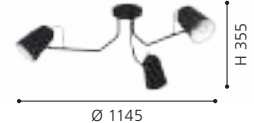





**900157**



**900614**



**900865**

### 900157 LORETO

wall light; steel, black, white  
Wandleuchte; Stahl, schwarz, weiss  
Applique; acier, noir, blanc

L 670, B 140, H 365



E27 1x 40W



9 008606 235766



L 670

### 900614 LORETO 1

wall light; steel, black, white  
Wandleuchte; Stahl, schwarz, weiss  
Applique; acier, noir, blanc

L 140, H 350, A 1030

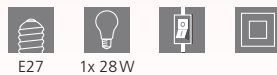

E27 1x 28W



9 008606 245116

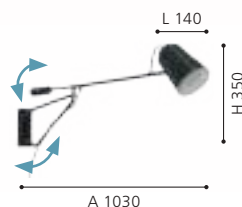

A 1030

### 900865 FORCADET

wall light; steel, black, grey  
Wandleuchte; Stahl, schwarz, grau  
Applique; acier, noir, gris

L 180, H 405, A 905

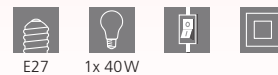

E27 1x 40W



9 008606 273942

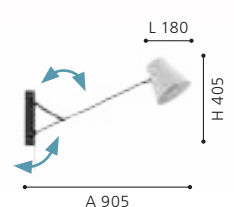

A 905



**900361**



98514



**98514**

### 900361 MARIEL

ceiling light; steel, wood, light grey, brown  
 Deckenleuchte; Stahl, Holz, hellgrau, braun  
 plafonnier; acier, bois, gris clair, marron

L 910, B 190, H 255



E27



3x 40W

### 98514 MAROJALES

ceiling light; steel, black / glass vaporized, black-transparent  
 Deckenleuchte; Stahl, schwarz / Glas bedampft, schwarz-transparent  
 plafonnier; acier, noir / verre vaporisé, noir transparent

L 555, B 180, H 280



E27



2x 28W



9 008606 239108



9 002759 985141





900825



900826



900185



### 900825 FILAGO

ceiling light; wood, steel, brown / glass, black-grey-transparent  
Deckenleuchte; Holz, Stahl, braun / Glas, schwarz-grau-transparent  
plafonnier; bois, acier, marron / verre, noir gris transparent

H 200, Ø 145



E27 1x 40W

### 900826 FILAGO

wall light; wood, steel, brown, black / glass, black-grey-transparent  
Wandleuchte; Holz, Stahl, braun, schwarz / Glas, schwarz-grau-transparent  
Applique; bois, acier, marron, noir / verre, noir gris transparent

L 145, H 200, A 200



E27 1x 40W

### 900185 FILAGO

ceiling light; steel, wood, black, brown / glass, black-grey-transparent  
Deckenleuchte; Stahl, Holz, schwarz, braun / Glas, schwarz-grau-transparent  
plafonnier; acier, bois, noir, marron / verre, noir gris transparent

L 880, B 145, H 250



E27 4x 40W



9 008606 263332



9 008606 263349



9 008606 235322





**92727**



**30931**

**LED**

**92727 CONDRA 1**

ceiling light; steel, chrome / satin glass, white  
 Deckenleuchte; Stahl, chrom / Glas satiniert, weiss  
 plafonnier; acier, chrome / verre satiné, blanc

L 470, B 470, H 300



**30931 CABO**

ceiling light; stainless steel, chrome / satin glass, white, clear  
 Deckenleuchte; Edelstahl, chrom / Glas satiniert, weiss, klar  
 plafonnier; acier inoxydable, chrome / verre satiné, blanc, transparent

L 290, B 290, H 70

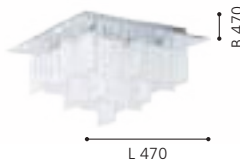
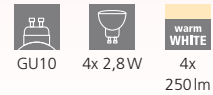



95639

LED



95284



CLEMENTE



95285

### 95639 ACOLLA

wall/ceiling light; steel, chrome / glass with brilliant glass, white, clear

Wand- / Deckenleuchte; Stahl, chrom / Glas mit Brillantglas, weiss, klar

Applique/Plafonnier; acier, chrome / verre avec verre brillant, blanc, transparent

H 85, Ø 290



3x 3,6W



1110lm



### 95284 CLEMENTE

ceiling light; steel, chrome / brilliant glass, clear

Deckenleuchte; Stahl, chrom / Brillantglas, klar

plafonnier; acier, chrome / verre brillant, transparent

H 200, Ø 350



E27



2x 60W

### 95285 CLEMENTE

ceiling light; steel, chrome / brilliant glass, clear

Deckenleuchte; Stahl, chrom / Brillantglas, klar

plafonnier; acier, chrome / verre brillant, transparent

H 205, Ø 450



E27



3x 60W



9 002759 956394



9 002759 952846

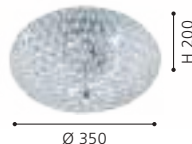

9 002759 952853

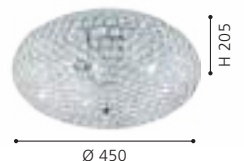



99324

LED



99325

LED



99328

LED

### 99324 FRADELO 1

wall/ceiling light; steel, black / plastic, brilliant glass, black, clear  
Wand- / Deckenleuchte; Stahl, schwarz / Kunststoff, Brillantglas, schwarz, klar  
Applique/Plafonnier; acier, noir / plastique, verre brillant, noir, transparent

L 140, B 140, H 60



1x 3,2W 400lm

### 99325 FRADELO 1

wall/ceiling light; steel, black / plastic, brilliant glass, black, clear  
Wand- / Deckenleuchte; Stahl, schwarz / Kunststoff, Brillantglas, schwarz, klar  
Applique/Plafonnier; acier, noir / plastique, verre brillant, noir, transparent

L 460, B 140, H 60



3x 3,5W 1200lm

### 99328 FRADELO 1

ceiling light; steel, black / plastic, brilliant glass, black, clear  
Deckenleuchte; Stahl, schwarz / Kunststoff, Brillantglas, schwarz, klar  
plafonnier; acier, noir / plastique, verre brillant, noir, transparent

L 520, B 520, H 95



46,5W 5500lm



9 002759 993245

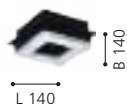

9 002759 993252



9 002759 993283





99327

LED



### 99327 FRADELO 1

ceiling light; steel, black / plastic, brilliant glass, black, clear  
 Deckenleuchte; Stahl, schwarz / Kunststoff, Brillantglas, schwarz, klar  
 plafonnier; acier, noir / plastique, verre brillant, noir, transparent

L 260, B 260, H 85

 LED	 warm WHITE	 LED	 warm WHITE	
4x 2W	920lm	1x 3,5W	400lm	





95655

LED



95656

LED

### 95655 FRADELO

wall/ceiling light; steel, chrome / plastic, brilliant glass, chrome, clear

Wand- / Deckenleuchte; Stahl, chrom / Kunststoff, Brillantglas, chrom, klar

Applique/Plafonnier; acier, chrome / plastique, verre brillant, chrome, transparent

L 140, B 140, H 60

LED

warm WHITE



1x 3,2W 400lm

### 95656 FRADELO

wall/ceiling light; steel, chrome / plastic, brilliant glass, chrome, clear

Wand- / Deckenleuchte; Stahl, chrom / Kunststoff, Brillantglas, chrom, klar

Applique/Plafonnier; acier, chrome / plastique, verre brillant, chrome, transparent

L 460, B 140, H 60

LED

warm WHITE



3x 3,5W 1200lm



9 002759 956554

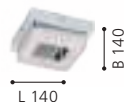

9 002759 956561







95661



95657



95659



### 95661 FRADELO

ceiling light; steel, chrome / plastic, brilliant glass, chrome, clear  
 Deckenleuchte; Stahl, chrom / Kunststoff, Brillantglas, chrom, klar  
 plafonnier; acier, chrome / plastique, verre brillant, chrome, transparent

L 520, B 520, H 95



46,5W 5500lm

### 95657 FRADELO

wall/ceiling light; steel, chrome / plastic, brilliant glass, chrome, clear  
 Wand- / Deckenleuchte; Stahl, chrom / Kunststoff, Brillantglas, chrom, klar  
 Applique/Plafonnier; acier, chrome / plastique, verre brillant, chrome, transparent

L 280, B 280, H 60



4x 3,5W 1600lm

### 95659 FRADELO

ceiling light; steel, chrome / plastic, brilliant glass, chrome, clear  
 Deckenleuchte; Stahl, chrom / Kunststoff, Brillantglas, chrom, klar  
 plafonnier; acier, chrome / plastique, verre brillant, chrome, transparent

L 260, B 260, H 85



4x 2W 920lm 1x 3,5W 400lm



9 002759 956615



9 002759 956578



9 002759 956592

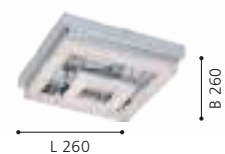



97487

LED



### 95689, 97487

These luminaires come with high quality brilliant glass.

Diese Leuchten sind mit hochwertigem Brillantglas ausgestattet.

Ces lumières sont fabriquées avec une haute qualité Equipé de verre brillant.



### 95689



### 97487 VALLEMARE

wall/ceiling light; aluminium, steel, chrome / plastic, brilliant glass, white, clear

Wand- / Deckenleuchte; Alu, Stahl, chrom / Kunststoff, Brillantglas, weiss, klar

Applique/Plafonnier; aluminium, acier, chrome / plastique, verre brillant, blanc, transparent

H 125, Ø 650



5x 6,6W 4500lm

### 95689 SORRENTA 1

wall/ceiling light; steel, white / glass with brilliant glass, white, clear

Wand- / Deckenleuchte; Stahl, weiss / Glas mit Brillantglas, weiss, klar

Applique/Plafonnier; acier, blanc / verre avec verre brillant, blanc, transparent

H 95, Ø 315



3x 3,8W 1170lm

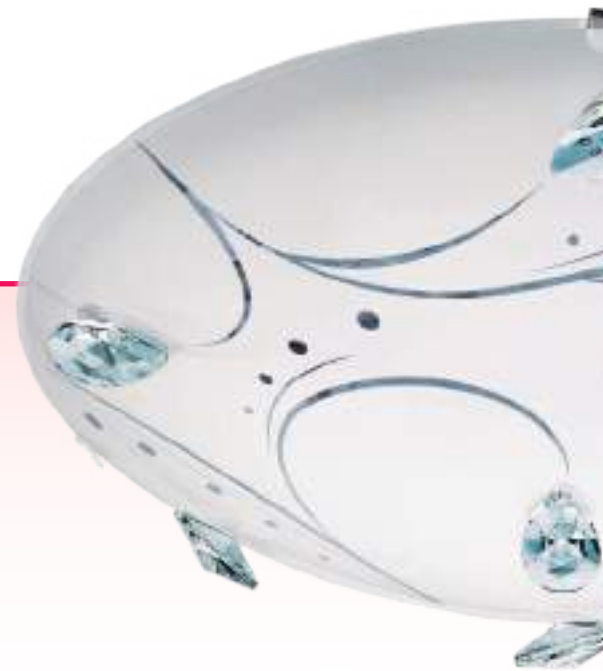

9 002759 974879

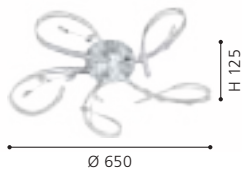

9 002759 956899





98527

LED

incl./inkl./inclus



 <b>TUNABLE WHITE</b>	 <b>STEP DIMMING</b>	 <b>NIGHT LIGHT FUNCTION</b>
--	---	---

98527

98685

1. warmwhite (2700 K/100 %)
2. neutralwhite 3850 K  
(2700 K/50 % + 5000 K/50 %)
3. coldwhite (5000 K/100 %)



98685

LED

incl./inkl./inclus



### 98527 CANICOSA 2

wall/ceiling light; plastic, steel, black, gold / plastic, granules, transparent

Wand- / Deckenleuchte; Kunststoff, Stahl, schwarz, gold / Kunststoff mit Granille, transparent

Applique/Plafonnier; plastique, acier, noir, or / plastique granité, transparent

H 90, Ø 495



24,5 W



3200 lm



Remote



### 98685 CANICOSA 2

wall/ceiling light; plastic, steel, black, gold / plastic, granules, transparent

Wand- / Deckenleuchte; Kunststoff, Stahl, schwarz, gold / Kunststoff mit Granille, transparent

Applique/Plafonnier; plastique, acier, noir, or / plastique granité, transparent

H 145, Ø 765



4x 4,5 W



2120 lm



3x 4,5 W



1590 lm



4x 2,2 W



1040 lm



Remote



9 002759 985271



9 002759 986858

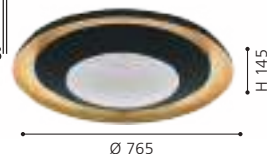



98487

LED



98023

LED



98488

LED

### 98023 MONTENOVO

wall/ceiling light; steel, white / glass, white, gold  
Wand- / Deckenleuchte; Stahl, weiss / Glas, weiss, gold  
Applique/Plafonnier; acier, blanc / verre, blanc, or

H 100, Ø 395



3x 7,3W 2220lm



9 002759 980238



### 98487 POZONDON

ceiling light; steel, gold-coloured / plastic, white  
Deckenleuchte; Stahl, goldfarben / Kunststoff, weiss  
plafonnier; acier, or / plastique, blanc

H 100, Ø 380



18W 2300lm



9 002759 984878

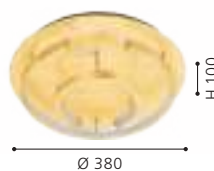

### 98488 POZONDON

ceiling light; steel, gold-coloured / plastic, white  
Deckenleuchte; Stahl, goldfarben / Kunststoff, weiss  
plafonnier; acier, or / plastique, blanc

H 120, Ø 520



22,5W 3100lm



9 002759 984885





97526



incl./inkl./inclus



97527



incl./inkl./inclus



97528



incl./inkl./inclus



 <b>TUNABLE WHITE</b> 3000 - 5000 K	 <b>DIMMABLE</b> 10 - 100 %	 <b>TIMER FUNCTION</b> off after 30sec.	 <b>NIGHT LIGHT FUNCTION</b>	<u>97526</u>	<u>97541</u>
				<u>97527</u>	<u>97542</u>
				<u>97528</u>	<u>97543</u>

### 97526 GIRON

ceiling light; steel, white / plastic, white  
Deckenleuchte; Stahl, weiss / Kunststoff, weiss  
plafonnier; acier, blanc / plastique, blanc

H 75, Ø 570



36W



4300lm



Remote

### 97527 GIRON

ceiling light; steel, white / plastic, white  
Deckenleuchte; Stahl, weiss / Kunststoff, weiss  
plafonnier; acier, blanc / plastique, blanc

H 85, Ø 760



54,5W



6500lm



Remote

### 97528 GIRON

ceiling light; steel, white / plastic, white  
Deckenleuchte; Stahl, weiss / Kunststoff, weiss  
plafonnier; acier, blanc / plastique, blanc

H 120, Ø 1000



73W



9800lm



Remote



9 002759 975265

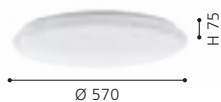

9 002759 975272

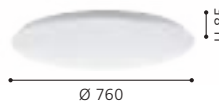

9 002759 975289





97541



incl./inkl./inclus



97542



incl./inkl./inclus



97543



incl./inkl./inclus



### 97541 GIRON-S

ceiling light; steel, white / plastic with crystal effect, white  
Deckenleuchte; Stahl, weiss / Kunststoff m.Kristalleffekt, weiss  
plafonnier; acier, blanc / plastique avec effet cristal, blanc

H 75, Ø 570



36W



4300lm



Remote

### 97542 GIRON-S

ceiling light; steel, white / plastic with crystal effect, white  
Deckenleuchte; Stahl, weiss / Kunststoff m.Kristalleffekt, weiss  
plafonnier; acier, blanc / plastique avec effet cristal, blanc

H 85, Ø 760



54,5W



6500lm



Remote

### 97543 GIRON-S

ceiling light; steel, white / plastic with crystal effect, white  
Deckenleuchte; Stahl, weiss / Kunststoff m.Kristalleffekt, weiss  
plafonnier; acier, blanc / plastique avec effet cristal, blanc

H 120, Ø 1000



73W



9800lm



Remote



9 002759 975418

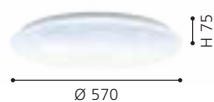

9 002759 975425



9 002759 975432

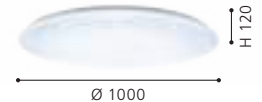



97871



97872



97873



### 97871 FRANIA

wall/ceiling light; steel, white / plastic, white  
Wand- / Deckenleuchte; Stahl, weiss / Kunststoff, weiss  
Applique/Plafonnier; acier, blanc / plastique, blanc

H 70, Ø 280



10W



1100lm



### 97872 FRANIA

wall/ceiling light; steel, white / plastic, white  
Wand- / Deckenleuchte; Stahl, weiss / Kunststoff, weiss  
Applique/Plafonnier; acier, blanc / plastique, blanc

H 70, Ø 330



14,6W



1600lm



### 97873 FRANIA

wall/ceiling light; steel, white / plastic, white  
Wand- / Deckenleuchte; Stahl, weiss / Kunststoff, weiss  
Applique/Plafonnier; acier, blanc / plastique, blanc

H 70, Ø 430



6x 5,5W



3600lm



9 002759 978716

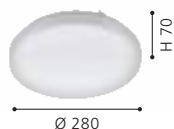

9 002759 978723



9 002759 978730







98446



## 98446 FRANIA

wall/ceiling light; steel, white / plastic, white

Wand- / Deckenleuchte; Stahl, weiss / Kunststoff, weiss

Applique/Plafonnier; acier, blanc / plastique, blanc

H 70, Ø 550



50W



5900lm



9 002759 984465





97877



97878



97879



### 97877 FRANIA-S

wall/ceiling light; steel, white / plastic with crystal effect, white  
Wand- / Deckenleuchte; Stahl, weiss / Kunststoff m.Kristalleffekt, weiss  
Applique/Plafonnier; acier, blanc / plastique avec effet cristal, blanc

H 70, Ø 280



10W



1100lm



### 97878 FRANIA-S

wall/ceiling light; steel, white / plastic with crystal effect, white  
Wand- / Deckenleuchte; Stahl, weiss / Kunststoff m.Kristalleffekt, weiss  
Applique/Plafonnier; acier, blanc / plastique avec effet cristal, blanc

H 70, Ø 330



14,6W



1600lm



### 97879 FRANIA-S

wall/ceiling light; steel, white / plastic with crystal effect, white  
Wand- / Deckenleuchte; Stahl, weiss / Kunststoff m.Kristalleffekt, weiss  
Applique/Plafonnier; acier, blanc / plastique avec effet cristal, blanc

H 70, Ø 430



6x 5,5W



3600lm



9 002759 978778



9 002759 978785



9 002759 978792





98448

LED



### 98448 FRANIA-S

wall/ceiling light; steel, white / plastic with crystal effect, white

Wand- / Deckenleuchte; Stahl, weiss / Kunststoff m. Kristalleffekt, weiss

Applique/Plafonnier; acier, blanc / plastique avec effet cristal, blanc

H 70, Ø 550



50W 5900lm

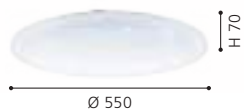



97874



97875



97876



### 97874 FRANIA

wall/ceiling light; steel, white / plastic, white  
Wand- / Deckenleuchte; Stahl, weiss / Kunststoff, weiss  
Applique/Plafonnier; acier, blanc / plastique, blanc

L 280, B 280, H 70



10W



1100lm



### 97875 FRANIA

wall/ceiling light; steel, white / plastic, white  
Wand- / Deckenleuchte; Stahl, weiss / Kunststoff, weiss  
Applique/Plafonnier; acier, blanc / plastique, blanc

L 330, B 330, H 70



14,6W



1600lm



### 97876 FRANIA

wall/ceiling light; steel, white / plastic, white  
Wand- / Deckenleuchte; Stahl, weiss / Kunststoff, weiss  
Applique/Plafonnier; acier, blanc / plastique, blanc

L 430, B 430, H 70



6x 5,5W



3600lm



9 002759 978747

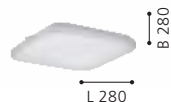

9 002759 978754

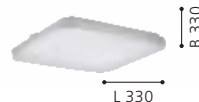

9 002759 978761

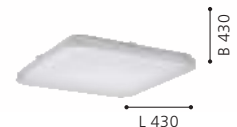



98447



### 98447 FRANIA

wall/ceiling light; steel, white / plastic, white  
Wand- / Deckenleuchte; Stahl, weiss / Kunststoff, weiss  
Applique/Plafonnier; acier, blanc / plastique, blanc

L 530, B 530, H 70



50W 5900lm





98449

LED



97882

LED



97881

LED



### 98449 FRANIA-S

wall/ceiling light; steel, white / plastic with crystal effect, white  
Wand- / Deckenleuchte; Stahl, weiss / Kunststoff m.Kristalleffekt, weiss

Applique/Plafonnier; acier, blanc / plastique avec effet cristal, blanc

L 530, B 530, H 70

LED

warm  
WHITE



50W

5900lm

### 97883 FRANIA-S

wall/ceiling light; steel, white / plastic with crystal effect, white  
Wand- / Deckenleuchte; Stahl, weiss / Kunststoff m.Kristalleffekt, weiss

Applique/Plafonnier; acier, blanc / plastique avec effet cristal, blanc

L 430, B 430, H 70

LED

warm  
WHITE



6x 5,5W

3600lm

### 97882 FRANIA-S

wall/ceiling light; steel, white / plastic with crystal effect, white  
Wand- / Deckenleuchte; Stahl, weiss / Kunststoff m.Kristalleffekt, weiss

Applique/Plafonnier; acier, blanc / plastique avec effet cristal, blanc

L 330, B 330, H 70

LED

warm  
WHITE



14,6W

1600lm



9 002759 984496



9 002759 978839



9 002759 978822

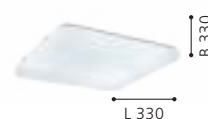



97883

LED



97577

LED

incl./inkl./inclus



97578

LED

incl./inkl./inclus



**TUNABLE WHITE**  
2700 - 6500 K

**STEP DIMMING**  
10/25/50/100 %

97577

97578

### 97881 FRANIA-S

wall/ceiling light; steel, white / plastic with crystal effect, white  
Wand- / Deckenleuchte; Stahl, weiss / Kunststoff m. Kristalleffekt, weiss  
Applique/Plafonnier; acier, blanc / plastique avec effet cristal, blanc

L 280, B 280, H 70

LED 10W  
warm WHITE 1100lm



9 002759 978815



### 97578 SILERAS

wall/ceiling light; steel, white / plastic with crystal effect, white  
Wand- / Deckenleuchte; Stahl, weiss / Kunststoff m. Kristalleffekt, weiss  
Applique/Plafonnier; acier, blanc / plastique avec effet cristal, blanc

H 85, Ø 600

LED 31W  
tunable WHITE 4600lm  
Remote



9 002759 975784



### 97577 SILERAS

wall/ceiling light; steel, white / plastic with crystal effect, white  
Wand- / Deckenleuchte; Stahl, weiss / Kunststoff m. Kristalleffekt, weiss  
Applique/Plafonnier; acier, blanc / plastique avec effet cristal, blanc

H 85, Ø 450

LED 20,5W  
tunable WHITE 2800lm  
Remote



9 002759 975777





98323

LED

incl./inkl./inclus



98324

LED

incl./inkl./inclus







97737

LED

incl./inkl./inclus



 <b>TUNABLE WHITE</b>	 <b>DIMMABLE</b>	 <b>TIMER FUNCTION</b>	 <b>NIGHT LIGHT FUNCTION</b>	<b>98323</b>
	10 - 100 %	off after 30sec.		<b>98324</b>
				<b>97737</b>

### 98323 LANCIANO 1

wall/ceiling light; steel, white, transparent / plastic with crystal effect, white, chrome

Wand- / Deckenleuchte; Stahl, weiss, transparent / Kunststoff m. Kristalleffekt, weiss, chrom

Applique/Plafonnier; acier, blanc, transparent / plastique avec effet cristal, blanc, chrome

H 75, Ø 400



18,8W



2300lm



Remote

### 98324 LANCIANO 1

wall/ceiling light; steel, white, transparent / plastic with crystal effect, white, chrome

Wand- / Deckenleuchte; Stahl, weiss, transparent / Kunststoff m. Kristalleffekt, weiss, chrom

Applique/Plafonnier; acier, blanc, transparent / plastique avec effet cristal, blanc, chrome

H 80, Ø 560



33W



4000lm



Remote

### 97737 LANCIANO

ceiling light; steel, plastic, white, transparent / plastic with crystal effect, white, silver

Deckenleuchte; Stahl, Kunststoff, weiss, transparent / Kunststoff m. Kristalleffekt, weiss, silber

plafonnier; acier, plastique, blanc, transparent / plastique avec effet cristal, blanc, argent

H 100, Ø 660



36W



4300lm



Remote



9 002759 983239



9 002759 983246



9 002759 977375







900598



incl./inkl./inclus



900599



incl./inkl./inclus



### 900598 LANCIANO 1

ceiling light; steel, wood, white, brown / plastic with crystal effect, white

Deckenleuchte; Stahl, Holz, weiss, braun / Kunststoff m. Kristalleffekt, weiss

plafonnier; acier, bois, blanc, marron / plastique avec effet cristal, blanc

H 70, Ø 380



24W



2600lm



### 900599 LANCIANO 1

ceiling light; steel, wood, white, brown / plastic with crystal effect, white

Deckenleuchte; Stahl, Holz, weiss, braun / Kunststoff m. Kristalleffekt, weiss

plafonnier; acier, bois, blanc, marron / plastique avec effet cristal, blanc

H 80, Ø 480



35W



4000lm



9 008606 244973



9 008606 244980

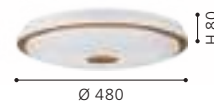



900608

LED



900607

LED

### 900608 FERENTINO

ceiling light; steel, white / plastic, white  
 Deckenleuchte; Stahl, weiss / Kunststoff, weiss  
 plafonnier; acier, blanc / plastique, blanc

H 60, Ø 380



19,5W 2300lm

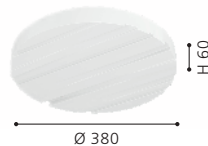

### 900607 FERENTINO

ceiling light; steel, white / plastic, white  
 Deckenleuchte; Stahl, weiss / Kunststoff, weiss  
 plafonnier; acier, blanc / plastique, blanc

H 60, Ø 280



10W 1100lm





900611



900609



### 900609 FERENTINO

ceiling light; steel, white / plastic, white  
Deckenleuchte; Stahl, weiss / Kunststoff, weiss  
plafonnier; acier, blanc / plastique, blanc

L 280, B 280, H 60



10W 1100lm

### 900611 FERENTINO

ceiling light; steel, white / plastic, white  
Deckenleuchte; Stahl, weiss / Kunststoff, weiss  
plafonnier; acier, blanc / plastique, blanc

L 330, B 330, H 60



14,6W 1600lm



9 008606 245079



9 008606 245086

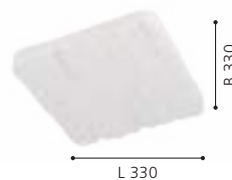



900606

LED

incl./inkl./inclus 



900605

LED

incl./inkl./inclus 



DESIGN  
HIGHLIGHT  
DETAIL

### 900605 BATTISTONA

ceiling light; steel, white / plastic, white  
Deckenleuchte; Stahl, weiss / Kunststoff, weiss  
plafonnier; acier, blanc / plastique, blanc

H 85, Ø 380

LED tunable WHITE LED tunable WHITE 

4x 2,9W 1280lm 4x 1,45W 640lm



Remote



9 008606 245031



### 900606 BATTISTONA

ceiling light; steel, white / plastic, white  
Deckenleuchte; Stahl, weiss / Kunststoff, weiss  
plafonnier; acier, blanc / plastique, blanc

H 100, Ø 480

LED tunable WHITE  CONTROL UNIT

20,8W 2500lm Remote



9 008606 245048





99344

LED



99343

LED



### 99343 BENARIBA

wall/ceiling light; steel, white / plastic, white  
Wand- / Deckenleuchte; Stahl, weiss / Kunststoff, weiss  
Applique/Plafonnier; acier, blanc / plastique, blanc

H 65, Ø 330



14,6W 1600lm

### 99344 BENARIBA

wall/ceiling light; steel, white / plastic, white  
Wand- / Deckenleuchte; Stahl, weiss / Kunststoff, weiss  
Applique/Plafonnier; acier, blanc / plastique, blanc

H 70, Ø 440



22W 2500lm



9 002759 993436



9 002759 993443





96032



96033



96034



### 96032 COMPETA 1

wall/ceiling light; steel, white / plastic, white, satin nickel

Wand- / Deckenleuchte; Stahl, weiss / Kunststoff, weiss, nickel-matt

Applique/Plafonnier; acier, blanc / plastique, blanc, nickel mat

H 55, Ø 245



15,6W 1900lm

### 96033 COMPETA 1

wall/ceiling light; steel, white / plastic, white, satin nickel

Wand- / Deckenleuchte; Stahl, weiss / Kunststoff, weiss, nickel-matt

Applique/Plafonnier; acier, blanc / plastique, blanc, nickel mat

H 55, Ø 325



18W 2200lm

### 96034 COMPETA 1

wall/ceiling light; steel, white / plastic, white, satin nickel

Wand- / Deckenleuchte; Stahl, weiss / Kunststoff, weiss, nickel-matt

Applique/Plafonnier; acier, blanc / plastique, blanc, nickel mat

H 55, Ø 430



20W 2400lm



9 002759 960322



9 002759 960339



9 002759 960346





95679

LED



95682

LED



95684

LED



### 95679 COMPETA 1

wall/ceiling light; steel, white / plastic, white, silver, clear  
Wand- / Deckenleuchte; Stahl, weiss / Kunststoff, weiss, silber, klar  
Applique/Plafonnier; acier, blanc / plastique, blanc, argent, transparent

L 340, B 340, H 80



21W 2400lm

### 95682 PALERMO 2

wall/ceiling light; steel, white / plastic, white, chrome  
Wand- / Deckenleuchte; Stahl, weiss / Kunststoff, weiss, chrom  
Applique/Plafonnier; acier, blanc / plastique, blanc, chrome

H 70, Ø 280



15,6W 1900lm

### 95684 PALERMO 2

wall/ceiling light; steel, white / plastic, white, chrome  
Wand- / Deckenleuchte; Stahl, weiss / Kunststoff, weiss, chrom  
Applique/Plafonnier; acier, blanc / plastique, blanc, chrome

H 60, Ø 410



20W 2400lm



9 002759 956790

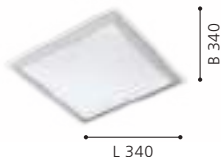

9 002759 956820



9 002759 956844

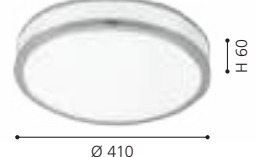



96023

LED



900149

LED



900335

LED

### 96023 CAPASSO

wall/ceiling light; steel, white / plastic, white, chrome  
Wand- / Deckenleuchte; Stahl, weiss / Kunststoff, weiss, chrom  
Applique/Plafonnier; acier, blanc / plastique, blanc, chrome

H 65, Ø 340

LED

18W

warm  
WHITE

2200lm



### 900149 CAPASSO

wall/ceiling light; steel, white / plastic, white, black  
Wand- / Deckenleuchte; Stahl, weiss / Kunststoff, weiss, schwarz  
Applique/Plafonnier; acier, blanc / plastique, blanc, noir

H 60, Ø 340

LED

14,6W

warm  
WHITE

1600lm



### 900335 CAPASSO

wall/ceiling light; steel, white / plastic, white, black  
Wand- / Deckenleuchte; Stahl, weiss / Kunststoff, weiss, schwarz  
Applique/Plafonnier; acier, blanc / plastique, blanc, noir

H 60, Ø 480

LED

19,5W

warm  
WHITE

2200lm



9 002759 960230



Ø 340



9 008606 243471



Ø 340



9 008606 243488



Ø 480





900612



900613



### 900612 RENDE

ceiling light; steel, white / plastic, white, gold  
Deckenleuchte; Stahl, weiss / Kunststoff, weiss, gold  
plafonnier; acier, blanc / plastique, blanc, or

H 60, Ø 380



19,5W 2300lm

### 900613 RENDE

ceiling light; steel, white / plastic, white, silver  
Deckenleuchte; Stahl, weiss / Kunststoff, weiss, silber  
plafonnier; acier, blanc / plastique, blanc, argent

L 380, B 380, H 60



19,5W 2300lm



9 008606 245093



9 008606 245109





900498

LED



900499

LED



900501

LED



### 900498 NIEVES 1

wall/ceiling light; steel, white / plastic, white, gold  
Wand- / Deckenleuchte; Stahl, weiss / Kunststoff, weiss, gold  
Applique/Plafonnier; acier, blanc / plastique, blanc, or

H 60, Ø 310

LED

warm  
WHITE



10W

1100lm

### 900499 NIEVES 1

wall/ceiling light; steel, white / plastic, white, gold  
Wand- / Deckenleuchte; Stahl, weiss / Kunststoff, weiss, gold  
Applique/Plafonnier; acier, blanc / plastique, blanc, or

H 65, Ø 410

LED

warm  
WHITE



19,5W

2300lm

### 900501 NIEVES 1

wall/ceiling light; steel, white / plastic, white, gold  
Wand- / Deckenleuchte; Stahl, weiss / Kunststoff, weiss, gold  
Applique/Plafonnier; acier, blanc / plastique, blanc, or

H 70, Ø 510

LED

warm  
WHITE



7x 4,4W

3710lm



9 008606 239634



9 008606 239641

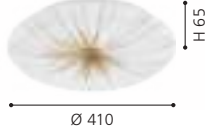

9 008606 239658

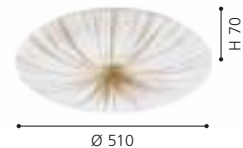



99699



98325



98326



### 99699 NIEVES

wall/ceiling light; steel, white / plastic, white, silver  
Wand- / Deckenleuchte; Stahl, weiss / Kunststoff, weiss, silber  
Applique/Plafonnier; acier, blanc / plastique, blanc, argent

H 60, Ø 310



10W 1100lm



9 002759 996994

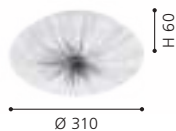

### 98325 NIEVES

wall/ceiling light; steel, white / plastic, white, silver  
Wand- / Deckenleuchte; Stahl, weiss / Kunststoff, weiss, silber  
Applique/Plafonnier; acier, blanc / plastique, blanc, argent

H 65, Ø 410



19,5W 2300lm



9 002759 983253

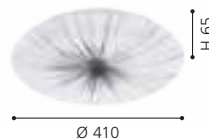

### 98326 NIEVES

wall/ceiling light; steel, white / plastic, white, silver  
Wand- / Deckenleuchte; Stahl, weiss / Kunststoff, weiss, silber  
Applique/Plafonnier; acier, blanc / plastique, blanc, argent

H 70, Ø 510



7x 4,4W 3710lm



9 002759 983260

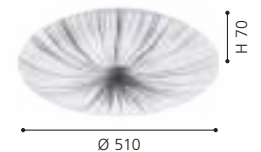



99406



99407



98603



### 99406 PESCAITO

wall/ceiling light; steel, black / plastic, white, gold  
Wand- / Deckenleuchte; Stahl, schwarz / Kunststoff, weiss, gold  
Applique/Plafonnier; acier, noir / plastique, blanc, or

H 65, Ø 280



10W



1100lm



### 99407 PESCAITO

wall/ceiling light; steel, black / plastic, white, gold  
Wand- / Deckenleuchte; Stahl, schwarz / Kunststoff, weiss, gold  
Applique/Plafonnier; acier, noir / plastique, blanc, or

H 65, Ø 380



19,5W



2300lm



### 98603 MUSURITA

ceiling light; plastic, steel, black / plastic, white  
Deckenleuchte; Kunststoff, Stahl, schwarz / Kunststoff, weiss  
plafonnier; plastique, acier, noir / plastique, blanc

H 60, Ø 340



14,6W



1600lm



9 002759 994068



9 002759 994075



9 002759 986032

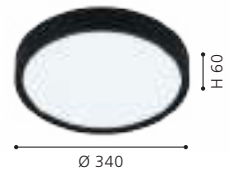



98604



98601



98602



### 98604 MUSURITA

ceiling light; plastic, steel, black / plastic, white  
 Deckenleuchte; Kunststoff, Stahl, schwarz / Kunststoff, weiss  
 plafonnier; plastique, acier, noir / plastique, blanc

H 75, Ø 440



6x 5,5 W 3600 lm



9 002759 986049



### 98601 MUSURITA

ceiling light; plastic, steel, natural wooden effect / plastic, white  
 Deckenleuchte; Kunststoff, Stahl, Holzoptik natur / Kunststoff, weiss  
 plafonnier; plastique, acier, aspect bois naturel / plastique, blanc

H 60, Ø 340



14,6 W 1600 lm



9 002759 986018

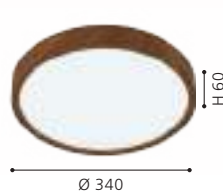

### 98602 MUSURITA

ceiling light; plastic, steel, natural wooden effect / plastic, white  
 Deckenleuchte; Kunststoff, Stahl, Holzoptik natur / Kunststoff, weiss  
 plafonnier; plastique, acier, aspect bois naturel / plastique, blanc

H 75, Ø 440



6x 5,5 W 3600 lm



9 002759 986025

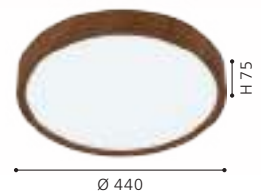



99782



incl./inkl./inclus



99783



incl./inkl./inclus



99779



incl./inkl./inclus

### 99782 LAURITO

ceiling light; steel, white / plastic, grey, white  
Deckenleuchte; Stahl, weiss / Kunststoff, grau, weiss  
plafonnier; acier, blanc / plastique, gris, blanc

H 70, Ø 490



24W



2600lm



Remote

### 99783 LAURITO

ceiling light; steel, white / plastic, black, white  
Deckenleuchte; Stahl, weiss / Kunststoff, schwarz, weiss  
plafonnier; acier, blanc / plastique, noir, blanc

H 70, Ø 490



24W



2600lm



Remote

### 99779 SELUCI

ceiling light; steel, white / plastic, white, clear  
Deckenleuchte; Stahl, weiss / Kunststoff, weiss, klar  
plafonnier; acier, blanc / plastique, blanc, transparent

H 80, Ø 490



4x 10W



4600lm



Remote



9 002759 997823



9 002759 997830



9 002759 997793





99781

LED

incl./inkl./inclus



### 99781 SELUCI

ceiling light; steel, black / plastic, white, clear

Deckenleuchte; Stahl, schwarz / Kunststoff, weiss, klar

plafonnier; acier, noir / plastique, blanc, transparent

H 80, Ø 490



4x 10W



4600lm



Remote



9 002759 997816



### SELUCI

Convenient light effect due to the indirect illumination.

Angenehmer Lichteffect durch indirekte Beleuchtung.

Effet de lumière pratique en raison de l'éclairage indirect.





99623

LED





99621



99622



### 99623 VALCASOTTO

ceiling light; steel, mocha-coloured / plastic, white  
 Deckenleuchte; Stahl, Mokkafarben / Kunststoff, weiss  
 plafonnier; acier, café / plastique, blanc

H 75, Ø 370



20W 2400lm

### 99621 VALCASOTTO

ceiling light; steel, black / plastic, white  
 Deckenleuchte; Stahl, schwarz / Kunststoff, weiss  
 plafonnier; acier, noir / plastique, blanc

H 75, Ø 370



20W 2400lm

### 99622 VALCASOTTO

ceiling light; steel, brown / plastic, white  
 Deckenleuchte; Stahl, braun / Kunststoff, weiss  
 plafonnier; acier, marron / plastique, blanc

H 75, Ø 370



20W 2400lm



9 002759 996239



9 002759 996215



9 002759 996222





900795



900796



**900795 LUPPINERIA**

ceiling light; steel, black / plastic, white  
 Deckenleuchte; Stahl, schwarz / Kunststoff, weiss  
 plafonnier; acier, noir / plastique, blanc

H 95, Ø 385



20W 2400lm

**900796 LUPPINERIA**

ceiling light; steel, matte brass / plastic, white  
 Deckenleuchte; Stahl, messing-matt / Kunststoff, weiss  
 plafonnier; acier, laiton mat / plastique, blanc

H 95, Ø 385



20W 2400lm



9 008606 267927



9 008606 267934

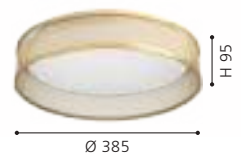



900463



900464



### 900463 LUPPINERIA

ceiling light; steel, plastic, sandy, white / wood, brown  
Deckenleuchte; Stahl, Kunststoff, sandfarben, weiss / Holz, braun  
plafonnier; acier, plastique, couleur sable, blanc / bois, marron

H 80, Ø 380



20W 2400lm



9 008606 244027



### 900464 LUPPINERIA

ceiling light; plastic, steel, white / wood, brown  
Deckenleuchte; Kunststoff, Stahl, weiss / Holz, braun  
plafonnier; plastique, acier, blanc / bois, marron

H 80, Ø 380



20W 2400lm



9 008606 244034





900797

LED



900857

LED



DESIGN  
HIGHLIGHT  
DETAIL

### 900797 LUPPINERIA

ceiling light; wood, steel, brown, white / plastic, white  
Deckenleuchte; Holz, Stahl, braun, weiss / Kunststoff, weiss  
plafonnier; bois, acier, marron, blanc / plastique, blanc

H 95, Ø 450



20W 2400lm

### 900857 PENJAMO 1

ceiling light; steel, wood, black, brown / plastic, white  
Deckenleuchte; Stahl, Holz, schwarz, braun / Kunststoff, weiss  
plafonnier; acier, bois, noir, marron / plastique, blanc

H 65, Ø 465



20W 2400lm



9 008606 267019

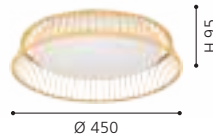

9 008606 271207





99703



99704



### 99703 PENJAMO

ceiling light; steel, black / plastic with crystal effect, white  
Deckenleuchte; Stahl, schwarz / Kunststoff m. Kristalleffekt, weiss  
plafonnier; acier, noir / plastique avec effet cristal, blanc

H 60, Ø 465



3x 7,3W 2010lm

### 99704 PENJAMO

ceiling light; steel, mocha-coloured / plastic with crystal effect, white  
Deckenleuchte; Stahl, Mokkafarben / Kunststoff m. Kristalleffekt, weiss  
plafonnier; acier, café / plastique avec effet cristal, blanc

H 60, Ø 465



3x 7,3W 2010lm



9 002759 997038



9 002759 997045





900601

LED



### 900601 CALAGRANO

ceiling light; steel, black / plastic, white  
Deckenleuchte; Stahl, schwarz / Kunststoff, weiss  
plafonnier; acier, noir / plastique, blanc

H 60, Ø 380

LED

11,5W

tunable  
WHITE

1500lm

LED

10W

tunable  
WHITE

1400lm



9 008606 244997





900602

LED

incl./inkl./inclus



900863

LED



900864

LED

### 900602 CALAGRANO

ceiling light; steel, black / plastic, white  
Deckenleuchte; Stahl, schwarz / Kunststoff, weiss  
plafonnier; acier, noir / plastique, blanc

L 375, B 375, H 60



11W 1600lm 10W 1400lm



9 008606 245000



### 900863 PALAGIANO

ceiling light; steel, white / plastic, steel, satin finish, white  
Deckenleuchte; Stahl, weiss / Kunststoff, Stahl, satiniert, weiss  
plafonnier; acier, blanc / plastique, acier, satiné, blanc

H 55, Ø 300



14,7W 2100lm



9 008606 264087



### 900864 PALAGIANO

ceiling light; steel, white / plastic, steel, satin finish, white  
Deckenleuchte; Stahl, weiss / Kunststoff, Stahl, satiniert, weiss  
plafonnier; acier, blanc / plastique, acier, satiné, blanc

H 55, Ø 380



21W 3100lm



9 008606 264094





32051



32052



32053



### 32051 PALAGIANO 1

ceiling light; steel, white / plastic, steel, satin finish, white  
Deckenleuchte; Stahl, weiss / Kunststoff, Stahl, satiniert, weiss  
plafonnier; acier, blanc / plastique, acier, satiné, blanc

H 50, Ø 300



14,7W 2100lm

### 32052 PALAGIANO 1

ceiling light; steel, white / plastic, steel, satin finish, white  
Deckenleuchte; Stahl, weiss / Kunststoff, Stahl, satiniert, weiss  
plafonnier; acier, blanc / plastique, acier, satiné, blanc

H 50, Ø 380



14,7W 2200lm

### 32053 PALAGIANO 1

ceiling light; steel, white / plastic, steel, satin finish, white  
Deckenleuchte; Stahl, weiss / Kunststoff, Stahl, satiniert, weiss  
plafonnier; acier, blanc / plastique, acier, satiné, blanc

H 50, Ø 480



21W 3200lm



9 002759 320515



9 002759 320522



9 002759 320539







99397



99398



### 99397 MENTALURGIA

wall/ceiling light; steel, white, chrome / plastic, white  
Wand- / Deckenleuchte; Stahl, weiss, chrom / Kunststoff, weiss  
Applique/Plafonnier; acier, blanc, chrome / plastique, blanc

L 495, B 465, H 65

LED 11 W	tunable WHITE 1400 lm	LED 9,8 W	tunable WHITE 1300 lm	LED 8,5 W	tunable WHITE 1250 lm
LED 6 W	tunable WHITE 850 lm	LED 5 W	tunable WHITE 600 lm		



9 002759 993979



### 99398 MENTALURGIA

wall/ceiling light; steel, white, chrome / plastic, white  
Wand- / Deckenleuchte; Stahl, weiss, chrom / Kunststoff, weiss  
Applique/Plafonnier; acier, blanc, chrome / plastique, blanc

L 490, B 490, H 65

LED 12 W	tunable WHITE 1750 lm	LED 11 W	tunable WHITE 1600 lm	LED 7,5 W	tunable WHITE 1050 lm
LED 5,5 W	tunable WHITE 750 lm	LED 4,4 W	tunable WHITE 550 lm		



9 002759 993986



### MENTALURGIA

The light color of the luminaires can be controlled via the wall switch.

Über den Wandschalter kann die Lichtfarbe der Leuchten gesteuert werden.

L'interrupteur mural permet de contrôler la couleur de la lumière des luminaires.



**81635**



**83404**



**81636**

### 81635 ELLA

wall/ceiling light; steel, white / matte-opal glass, white  
Wand- / Deckenleuchte; Stahl, weiss / Glas opal-matt, weiss  
Applique/Plafonnier; acier, blanc / verre opale mat, blanc

H 92, Ø 200



E27

1x 60W

### 81636 ELLA

wall/ceiling light; steel, white / matte-opal glass, white  
Wand- / Deckenleuchte; Stahl, weiss / Glas opal-matt, weiss  
Applique/Plafonnier; acier, blanc / verre opale mat, blanc

H 117, Ø 280



E27

1x 60W

### 83404 ELLA

wall/ceiling light; steel, white / matte-opal glass, white  
Wand- / Deckenleuchte; Stahl, weiss / Glas opal-matt, weiss  
Applique/Plafonnier; acier, blanc / verre opale mat, blanc

H 127, Ø 350



E27

2x 60W



9 002759 816353



9 002759 816360



9 002759 834043





**94973**

**94973 DURELO**

ceiling light; plastic, white / glass, white  
Deckenleuchte; Kunststoff, weiss / Glas, weiss  
plafonnier; plastique, blanc / verre, blanc

H 195, Ø 160



E27



1x 28W



9 002759 949730





**82942**



**83155**



**83153**

### 82942 PLANET

wall/ceiling light; steel, satin nickel / satin glass, white, clear  
Wand- / Deckenleuchte; Stahl, nickel-matt / Glas satiniert, weiss, klar  
Applique/Plafonnier; acier, nickel mat / verre satiné, blanc, transparent

H 85, Ø 290



E27



1x 25W

### 83155 PLANET 1

wall/ceiling light; steel, chrome / painted glass, white, clear  
Wand- / Deckenleuchte; Stahl, chrom / Glas lackiert, weiss, klar  
Applique/Plafonnier; acier, chrome / verre laqué, blanc, transparent

H 85, Ø 290



E27



1x 25W

### 83153 PLANET 1

wall/ceiling light; steel, white / painted glass, white, clear  
Wand- / Deckenleuchte; Stahl, weiss / Glas lackiert, weiss, klar  
Applique/Plafonnier; acier, blanc / verre laqué, blanc, transparent

H 85, Ø 290



E27



1x 25W



9 002759 829421



Ø 290



9 002759 831554



Ø 290



9 002759 831530



Ø 290



**83156**



**83154**

### 83156 PLANET 1

wall light; steel, chrome / painted glass, white, clear  
 Wandleuchte; Stahl, chrom / Glas lackiert, weiss, klar  
 Applique; acier, chrome / verre laqué, blanc, transparent

L 290, H 145, A 85



### 83154 PLANET 1

wall light; steel, white / painted glass, white, clear  
 Wandleuchte; Stahl, weiss / Glas lackiert, weiss, klar  
 Applique; acier, blanc / verre laqué, blanc, transparent

L 290, H 145, A 85



9 002759 831561



9 002759 831547





**83157**



**83159**

### 83157 PLANET 1

wall/ceiling light; steel, brass / painted glass, white, clear  
Wand- / Deckenleuchte; Stahl, messing / Glas lackiert, weiss, klar  
Applique/Plafonnier; acier, laiton / verre laqué, blanc, transparent

H 85, Ø 290



E27



1x 25W



9 002759 831578



Ø 290

### 83159 PLANET 1

wall/ceiling light; steel, black / painted glass, white, clear  
Wand- / Deckenleuchte; Stahl, schwarz / Glas lackiert, weiss, klar  
Applique/Plafonnier; acier, noir / verre laqué, blanc, transparent

H 85, Ø 290



E27



1x 25W



9 002759 831592



Ø 290

### 83162 PLANET 1

wall/ceiling light; steel, satin nickel / painted glass, white, clear  
Wand- / Deckenleuchte; Stahl, nickel-matt / Glas lackiert, weiss, klar  
Applique/Plafonnier; acier, nickel mat / verre laqué, blanc, transparent

H 85, Ø 290



E27



1x 25W



9 002759 831622



Ø 290



**83162**



**83163**

### 83163 PLANET 1

wall light; steel, satin nickel / painted glass, white, clear  
Wandleuchte; Stahl, nickel-matt / Glas lackiert, weiss, klar  
Applique; acier, nickel mat / verre laqué, blanc, transparent

L 290, H 145, A 85



E27



1x 60W



9 002759 831639

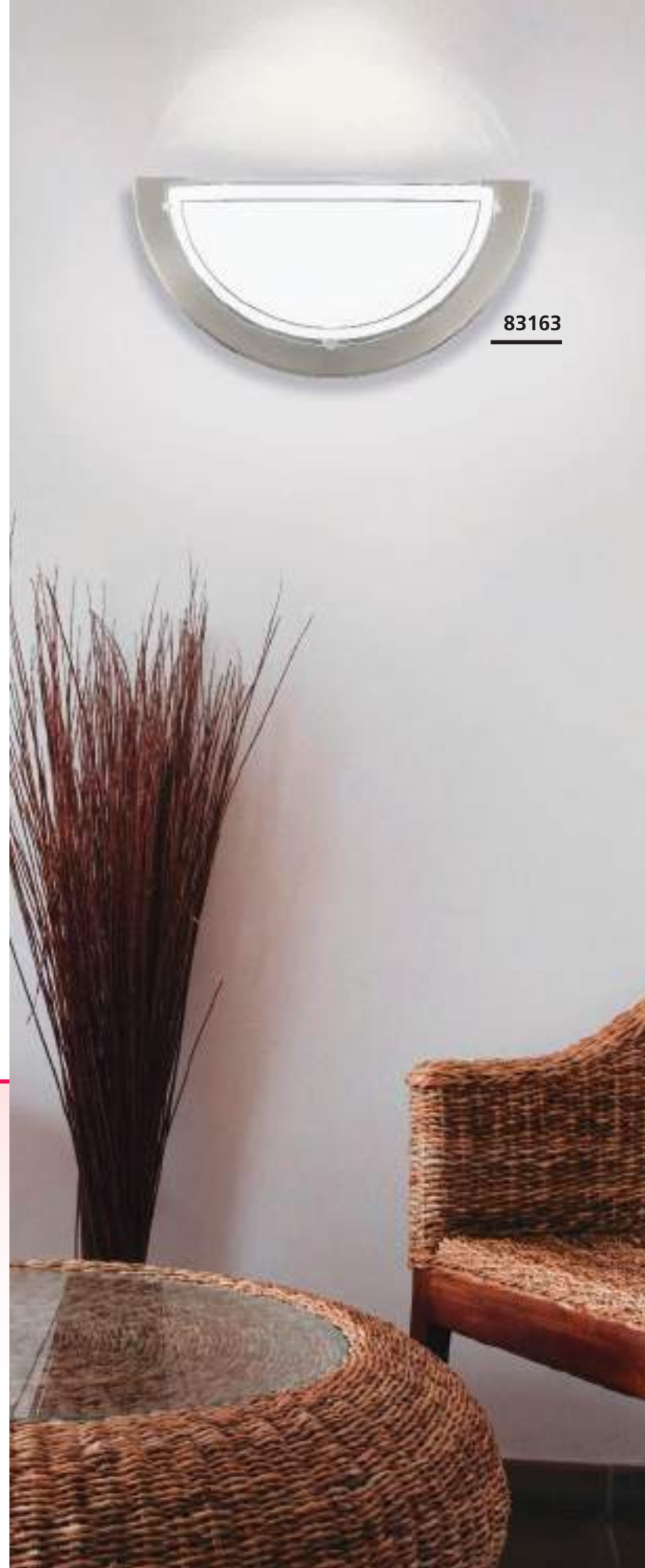



96117

LED







96089

LED



96111

LED

### 96117 MARGITTA 1

wall/ceiling light; steel, white / glass, white, black, clear  
Wand- / Deckenleuchte; Stahl, weiss / Glas, weiss, schwarz, klar  
Applique/Plafonnier; acier, blanc / verre, blanc, noir, transparent

H 95, Ø 315



3x 3,6W 1110lm



9 002759 961176



Ø 315

### 96089 MARGITTA 1

wall/ceiling light; steel, white / glass, white granules, clear  
Wand- / Deckenleuchte; Stahl, weiss / Glas, granille weiss, klar  
Applique/Plafonnier; acier, blanc / verre, blanc granille, transparent

H 70, Ø 250



3x 3,6W 960lm



9 002759 960896



Ø 250

### 96111 MARGITTA 1

wall/ceiling light; steel, white / glass, white granules, clear  
Wand- / Deckenleuchte; Stahl, weiss / Glas, granille weiss, klar  
Applique/Plafonnier; acier, blanc / verre, blanc granille, transparent

H 95, Ø 315



3x 3,6W 960lm



9 002759 961114



Ø 315



**89248**



**89239**

### 89248 MARS 1

wall/ceiling light; steel, white / satin glass, white, silver  
 Wand- / Deckenleuchte; Stahl, weiss / Glas satiniert, weiss, silber  
 Applique/Plafonnier; acier, blanc / verre satiné, blanc, argent

H 70, Ø 250



E27



1x 25W



9 002759 892487



Ø 250

### 89239 MARS 1

wall/ceiling light; steel, white / satin glass, sunbeam motif  
 Wand- / Deckenleuchte; Stahl, weiss / Glas satiniert, Motiv Strahlen  
 Applique/Plafonnier; acier, blanc / verre satiné, motif «rayons»

H 70, Ø 250



E27



1x 25W



9 002759 892395



Ø 250



**80263**



**80264**



**89238**

### 80264 MARS

wall/ceiling light; steel, white / satin glass, leaf motif  
 Wand- / Deckenleuchte; Stahl, weiss / Glas satiniert, Motiv Blätter  
 Applique/Plafonnier; acier, blanc / verre satiné, motif «feuilles»

H 70, Ø 250



E27 1x 25W



9 002759 802646



Ø 250

### 80263 MARS

wall/ceiling light; steel, white / satin glass, triangle motif  
 Wand- / Deckenleuchte; Stahl, weiss / Glas satiniert, Motiv Dreiecke  
 Applique/Plafonnier; acier, blanc / verre satiné, motif «triangles»

H 70, Ø 250



E27 1x 25W



9 002759 802639



Ø 250

### 89238 MARS 1

wall/ceiling light; steel, white / satin glass, rose motif  
 Wand- / Deckenleuchte; Stahl, weiss / Glas satiniert, Motiv Rose  
 Applique/Plafonnier; acier, blanc / verre satiné, motif «rose»

H 70, Ø 250



E27 1x 25W



9 002759 892388



Ø 250



**80265**



**7186**



**7184**

### 80265 MARS

wall/ceiling light; steel, white / satin glass, white  
Wand- / Deckenleuchte; Stahl, weiss / Glas satiniert, weiss  
Applique/Plafonnier; acier, blanc / verre satiné, blanc

H 70, Ø 250



E27



1x 25W



9 002759 802653



Ø 250

### 7186 SALOME

wall/ceiling light; steel, chrome / alabaster glass, white  
Wand- / Deckenleuchte; Stahl, chrom / Glas alabaster, weiss  
Applique/Plafonnier; acier, chrome / verre albâtre, blanc

H 90, Ø 300



E27



1x 25W



9 002759 718602



Ø 300

### 7184 SALOME

wall/ceiling light; steel, chrome / alabaster glass, white  
Wand- / Deckenleuchte; Stahl, chrom / Glas alabaster, weiss  
Applique/Plafonnier; acier, chrome / verre albâtre, blanc

H 110, Ø 400



E27



2x 25W



9 002759 718404



Ø 400



7188

### 7188 SALOME

wall light; steel, chrome / alabaster glass, white  
Wandleuchte; Stahl, chrom / Glas alabaster, weiss  
Applique; acier, chrome / verre albâtre, blanc

L 300, H 150, A 90



E27



1x 60W



9 002759 718800



### SALOME

These luminaires have a beautiful alabaster glass.

Diese Leuchten besitzen ein wunderschönes Alabasterglas.

Ces luminaires ont un beau verre d'albâtre.





95672



90043

DESIGN  
HIGHLIGHT  
DETAIL

### 95672 MAGITTA 1

wall/ceiling light; steel, white / glass, white, clear  
Wand- / Deckenleuchte; Stahl, weiss / Glas, weiss, klar  
Applique/Plafonnier; acier, blanc / verre, blanc, transparent

H 80, Ø 250



3x 3,6W 1110lm

### 90043 SCALEA 1

wall/ceiling light; steel, white / satin glass, white with decoration  
Wand- / Deckenleuchte; Stahl, weiss / Glas satiniert, weiss  
m.Dekor  
Applique/Plafonnier; acier, blanc / verre satiné, blanc avec décor

H 100, Ø 315



E27 1x 25W



9 002759 956721



Ø 250



9 002759 900434



Ø 315



**83132**



**83119**



**84028**

### 83132 GRAFIK

wall/ceiling light; steel / satin glass, line motif  
Wand- / Deckenleuchte; Stahl / Glas satiniert, Motiv Linien  
Applique/Plafonnier; acier / verre satiné, motif «lignes»

L 180, H 210, A 85

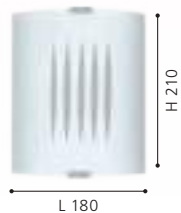

### 84028 GRAFIK

wall/ceiling light; steel, silver / satin glass, white  
Wand- / Deckenleuchte; Stahl, silber / Glas satiniert, weiss  
Applique/Plafonnier; acier, argent / verre satiné, blanc

L 180, H 210, A 85



### 83119 NEMO

wall light; steel, satin nickel / matte-opal glass, white  
Wandleuchte; Stahl, nickel-matt / Glas opal-matt, weiss  
Applique; acier, nickel mat / verre opale mat, blanc

L 150, H 320, A 95





DESIGN  
HIGHLIGHT  
DETAIL



82741



86712

### 86712 MESTRE

wall/ceiling light; steel, antique brown, gold / chalked glass, beige  
Wand- / Deckenleuchte; Stahl, antik-braun, gold / Glas gekalkt, beige  
Applique/Plafonnier; acier, marron antique, or / verre chaulé, beige  
H 133, Ø 395



E27 2x 60W

### 82741 IMPERIAL

wall/ceiling light; cast metal, bronzed / satin glass, white  
Wand- / Deckenleuchte; Metallguss, brüniert / Glas satiniert, weiss  
Applique/Plafonnier; fonte métallique, brun / verre satiné, blanc

H 140, Ø 310



E27 2x 25W



9 002759 867126



9 002759 827410







**89115**



**86715**



**87793**

### 89115 ALMERA

wall light; steel, antique brown / glass, champagne  
Wandleuchte; Stahl, antik-braun / Glas, champagner  
Applique; acier, marron antique / verre, champagne

L 180, H 250, A 75



E14



1x 60W



9 002759 891152



### 86715 MESTRE

wall light; steel, antique brown, gold / chalked glass, beige  
Wandleuchte; Stahl, antik-braun, gold / Glas gekalkt, beige  
Applique; acier, marron antique, or / verre chaulé, beige

L 300, H 335, A 160



E27



1x 60W



9 002759 867157



### 87793 PASCAL 1

wall light; steel, antique brown / chalked glass, beige  
Wandleuchte; Stahl, antik-braun / Glas gekalkt, beige  
Applique; acier, marron antique / verre chaulé, beige

L 180, H 480, A 120



E14



1x 60W



9 002759 877934





**90737**

**90737, 90697**

Rustic luminaire series with appealing leaf decor

Rustikale Leuchtenserie mit ansprechendem Blätterdekor

Série de luminaires rustique avec un décor de feuille plaisant



**90697**

### 90737 CAMPANIA

ceiling light; steel, antique brown, gold / chalked glass, white  
Deckenleuchte; Stahl, antik-braun, gold / Glas gekalkt, weiss  
plafonnier; acier, marron antique, or / verre chaulé, blanc

H 115, Ø 775



G4 15x 10W

### 90697 GERBERA 1

ceiling light; steel, antique brown, gold / satin glass, white  
Deckenleuchte; Stahl, antik-braun, gold / Glas satiniert, weiss  
plafonnier; acier, marron antique, or / verre satiné, blanc

H 90, Ø 780



G9 6x 33W

### 92143 COLTI

ceiling light; steel, antique brown / satin glass, white painted  
Deckenleuchte; Stahl, antik-braun / Glas satiniert, weiss lackiert  
plafonnier; acier, marron antique / verre satiné, blanc laqué

H 95, Ø 350



E27 2x 25W



9 002759 907372

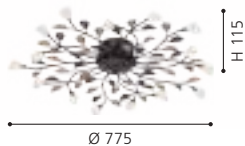

Ø 775



9 002759 906979

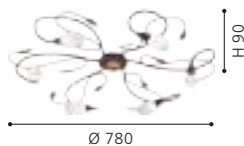

Ø 780



9 002759 921439

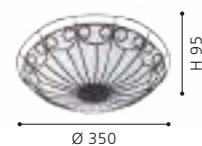

Ø 350



92143





**97886**



**99348**

Matching fabric luminaires  
can be found from page 130.

Passende Stoffleuchten finden  
Sie ab Seite 130.

Vous trouverez les luminaires à textile  
assorties à partir de la page 130.

**97886 SAN PERI**

wall light; steel, black  
Wandleuchte; Stahl, schwarz  
Applique; acier, noir

L 130, B 300, H 210



E27 1x 10W



9 002759 978860



**99348 STAITI 1**

wall light; steel, black / fabric, black  
Wandleuchte; Stahl, schwarz / Textil, schwarz  
Applique; acier, noir / tissu, noir

L 160, H 240, A 500



E27 1x 40W



9 002759 993481

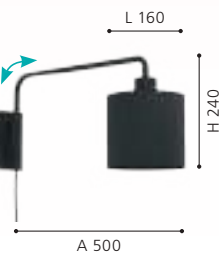



99348



96567



## TAZZOLI

These luminaires have a USB-connection.

Diese Leuchten verfügen über einen USB-Anschluss.

Ces luminaires disposent d'une connexion USB.



USB



96566

LED

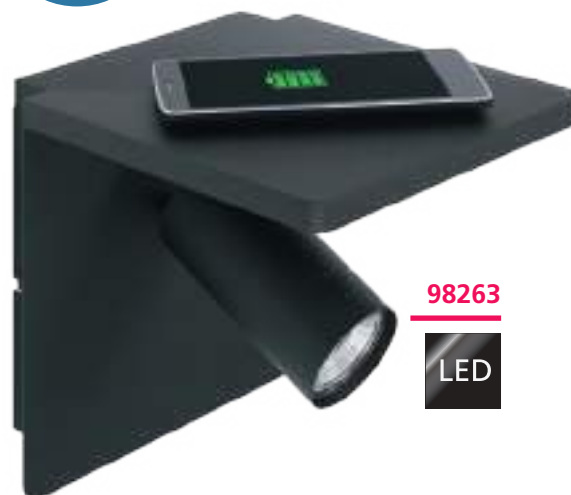

98263

LED

### 96567 TAZZOLI

wall light; steel, plastic, satin nickel, black  
Wandleuchte; Stahl, Kunststoff, nickel-matt, schwarz  
Applique; acier, plastique, nickel mat, noir

L 65, H 300, A 160



3,8W 320lm



9 002759 965679



### 96566 TAZZOLI

wall light; steel, plastic, white  
Wandleuchte; Stahl, Kunststoff, weiss  
Applique; acier, plastique, blanc

L 65, H 300, A 160



3,8W 320lm



9 002759 965662



### 98263 CIGLIE

wall light; aluminium, steel, black  
Wandleuchte; Alu, Stahl, schwarz  
Applique; aluminium, acier, noir

L 180, H 180, A 210

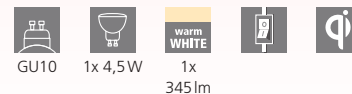

GU10 1x 4,5W 1x 345lm



9 002759 982638





99595

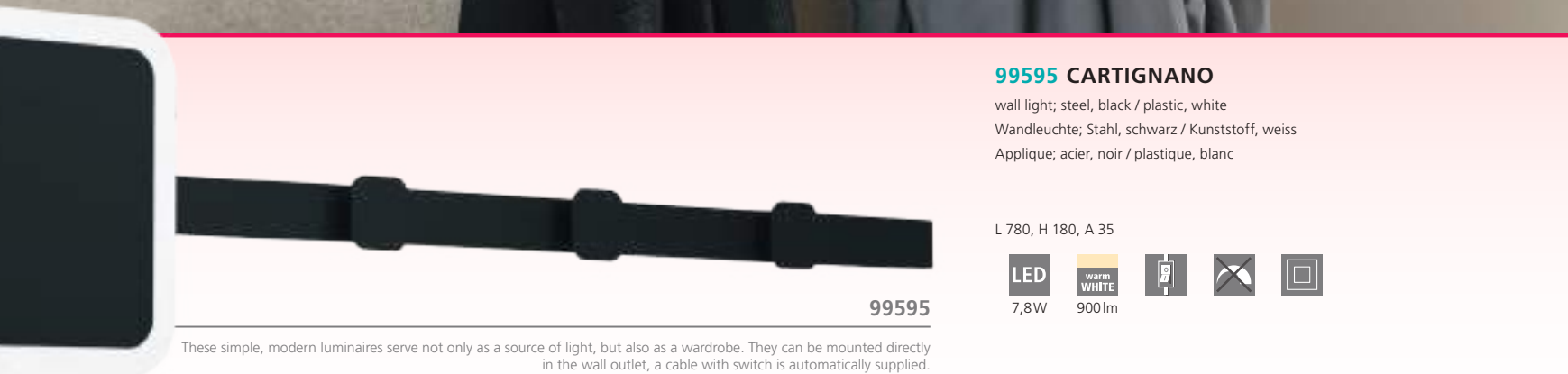

99595

These simple, modern luminaires serve not only as a source of light, but also as a wardrobe. They can be mounted directly in the wall outlet, a cable with switch is automatically supplied.

Diese schlichten, modernen Leuchten dienen nicht nur als Lichtquelle, sondern auch als Garderobe. Sie können direkt im Wandauslass montiert werden, ein Kabel mit Schalter wird automatisch mitgeliefert.

Ces luminaires sobres et modernes ne servent pas seulement de source de lumière, mais aussi de portemanteau. Ils peuvent être montés directement dans le diffuseur mural, un câble avec interrupteur est automatiquement fourni.

### 99595 CARTIGNANO

wall light; steel, black / plastic, white  
Wandleuchte; Stahl, schwarz / Kunststoff, weiss  
Applique; acier, noir / plastique, blanc

L 780, H 180, A 35

LED

7,8W

warm  
WHITE

900lm







99596



## 99596 CIVITATE

wall light; steel, wood, black, brown  
 Wandleuchte; Stahl, Holz, schwarz, braun  
 Applique; acier, bois, noir, marron

L 760, B 100, H 85



18W 1900lm



## 99596

LED wall luminaires CIVITATE consist of a rectangular black metal body with rounded corners. Thanks to the five holders made of brown rubber wood, the wall luminaires offer enough space for jackets as well as coats and can thus be optimally used as an illuminated coat rack. The luminaires provide pleasant warm white light, creating indirect lighting in the entrance area. The minimalist luminaires round off modern interior styles and are conveniently switched on and off via a switch on the cable.

Die LED Wandleuchten CIVITATE bestehen aus einem rechteckigen, schwarzen Metall-Körper mit abgerundeten Ecken. Dank der fünf Halterungen aus braunem Gummibaumholz bieten die Wandlampen genügend Platz für Jacken sowie Mäntel und kann so optimal als beleuchtete Garderobe genutzt werden. Die Leuchten spenden angenehmes warmweißes Licht und schaffen so eine indirekte Beleuchtung im Eingangsbereich. Die minimalistischen Leuchten runden moderne Einrichtungsstile ab und sind bequem über einen Schalter am Kabel ein- und ausschaltbar.

Les appliques LED CIVITATE se composent d'un corps rectangulaire en métal noir aux coins arrondis. Grâce aux cinq supports en bois d'hévéa brun, les appliques offrent suffisamment de place pour les vestes et les manteaux et peuvent ainsi être utilisées de manière optimale comme portemanteau éclairé. Les luminaires diffusent une agréable lumière blanche chaude et créent ainsi un éclairage indirect dans la zone d'entrée. Les luminaires minimalistes complètent les styles d'aménagement modernes et s'allument et s'éteignent facilement grâce à un interrupteur sur le câble.



**900525**

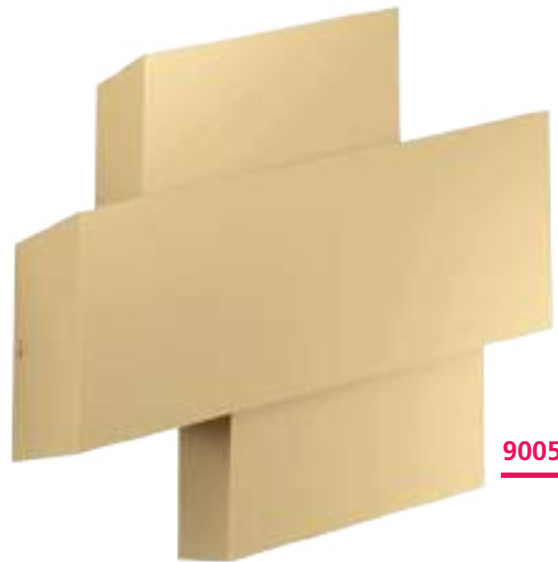

**900526**

**900525 TIMPAROSSA**

wall light; steel, white  
Wandleuchte; Stahl, weiss  
Applique; acier, blanc

L 255, H 220, A 105



E27



1x 40W

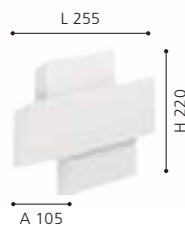

**900526 TIMPAROSSA**

wall light; steel, gold-coloured  
Wandleuchte; Stahl, goldfarben  
Applique; acier, or

L 255, H 220, A 105



E27



1x 40W

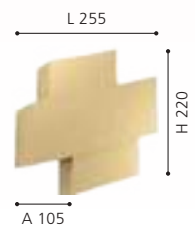



900717

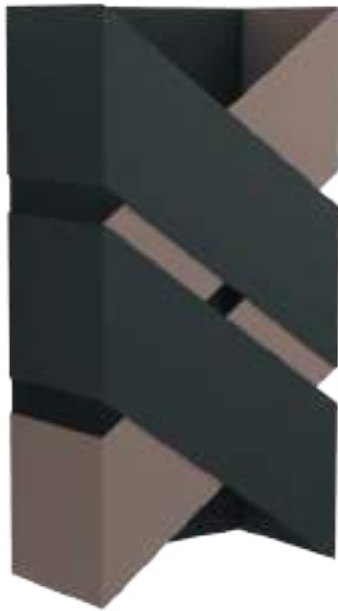

99689



98841



### 900717 ALAMILO

wall light; steel, white / wood, brown  
Wandleuchte; Stahl, weiss / Holz, braun  
Applique; acier, blanc / bois, marron

Ø 220, A 35



9,2W

### 99689 GURARE

wall light; steel, black, mocha-coloured  
Wandleuchte; Stahl, schwarz, mokkafarben  
Applique; acier, noir, café

L 125, H 240, A 85

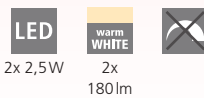

2x 2,5W

2x 180lm

### 98841 ZINACUA

wall light; steel, silver  
Wandleuchte; Stahl, silber  
Applique; acier, argent

L 225, H 310, A 85

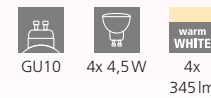

GU10

4x 4,5W

4x 345lm



9 008606 256969



9 002759 996895



9 002759 988418

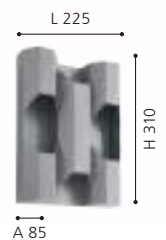



99087



99086



900325



### ZUBIALDE

The front panel of the luminaires can be swiveled. Thus, the light pattern can be adjusted individually.

Die Frontplatte der Leuchten ist schwenkbar. Somit kann das Lichtbild individuell eingestellt werden.

La plaque frontale des luminaires est orientable. Ainsi, l'image lumineuse peut être réglée individuellement.



### 99087 ZUBIALDE

wall light; aluminium, steel, black, white  
Wandleuchte; Alu, Stahl, schwarz, weiss  
Applique; aluminium, acier, noir, blanc

L 360, H 80, A 50



12W 1550lm



9 002759 990879



### 99086 ZUBIALDE

wall light; aluminium, steel, white  
Wandleuchte; Alu, Stahl, weiss  
Applique; aluminium, acier, blanc

L 360, H 80, A 50



12W 1550lm



9 002759 990862



### 900325 ZUBIALDE

wall light; steel, wood, black, brown  
Wandleuchte; Stahl, Holz, schwarz, braun  
Applique; acier, bois, noir, marron

L 360, H 80, A 50



12W 1550lm



9 008606 235360





**900871**

LED



**96049**

LED



**900871**

These luminaires can be mounted left or right sideways to the wall. This creates a beautiful grazing light.

Diese Leuchten können links und rechts, seitlich zur Wand montiert werden. Dabei entsteht ein schönes Streiflicht.

Ces luminaires peuvent être montés latéralement à gauche ou à droite du mur. Cela crée une belle lumière rasante.



**96048**

LED

### 900871 TUDONS

wall light; aluminium, steel, wood, black, brown  
Wandleuchte; Alu, Stahl, Holz, schwarz, braun  
Applique; aluminium, acier, bois, noir, marron

L 560, B 60, H 45



1x 12W 1300lm



9 008606 274468

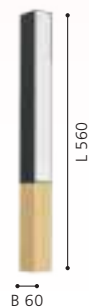

### 96049 ONO 2

wall light; aluminium, anthracite / plastic, clear  
Wandleuchte; Alu, anthrazit / Kunststoff, klar  
Applique; aluminium, gris anthracite / plastique, transparent

L 90, H 80, A 130



2x 2,5W 500lm



9 002759 960490



### 96048 ONO 2

wall light; aluminium, white / plastic, clear  
Wandleuchte; Alu, weiss / Kunststoff, klar  
Applique; aluminium, blanc / plastique, transparent

L 90, H 80, A 130



2x 2,5W 500lm



9 002759 960483

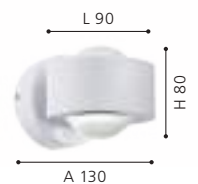



98542



98541



98543



### 98541 MACCARI

wall light; aluminium, steel, white / plastic, transparent  
 Wandleuchte; Alu, Stahl, weiss / Kunststoff, transparent  
 Applique; aluminium, acier, blanc / plastique, transparent

L 270, H 75, A 130



### 98542 MACCARI

wall light; aluminium, steel, black, gold / plastic, transparent  
 Wandleuchte; Alu, Stahl, schwarz, gold / Kunststoff, transparent  
 Applique; aluminium, acier, noir, or / plastique, transparent

L 270, H 75, A 130



### 98543 MACCARI

wall light; aluminium, steel, white, satin nickel / plastic, transparent  
 Wandleuchte; Alu, Stahl, weiss, nickel-matt / Kunststoff, transparent  
 Applique; aluminium, acier, blanc, nickel mat / plastique, transparent

L 270, H 75, A 130

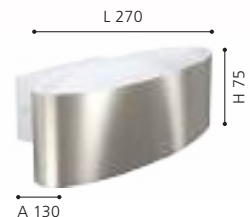



98544



98545



### 98544 FELONICHE

wall light; aluminium, white / plastic, transparent  
 Wandleuchte; Alu, weiss / Kunststoff, transparent  
 Applique; aluminium, blanc / plastique, transparent

L 220, H 100, A 75



10W 1300lm



9 002759 985448

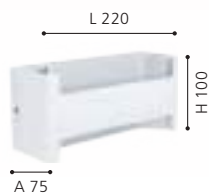

### 98545 FELONICHE

wall light; aluminium, black, gold / plastic, transparent  
 Wandleuchte; Alu, schwarz, gold / Kunststoff, transparent  
 Applique; aluminium, noir, or / plastique, transparent

L 220, H 100, A 75



10W 1300lm



9 002759 985455

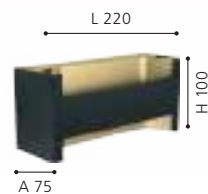



98421



98422



98423



**98421 SANIA 4**

wall light; aluminium, white  
Wandleuchte; Alu, weiss  
Applique; aluminium, blanc

L 130, H 80, A 90



9 002759 984212



**98422 SANIA 4**

wall light; aluminium, white  
Wandleuchte; Alu, weiss  
Applique; aluminium, blanc

L 200, H 80, A 90



9 002759 984229

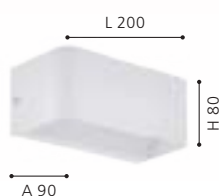

**98423 SANIA 4**

wall light; aluminium, white  
Wandleuchte; Alu, weiss  
Applique; aluminium, blanc

L 365, H 80, A 90



9 002759 984236

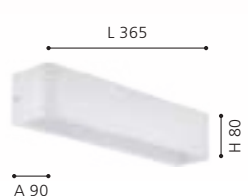





98424



98425



98426



### 98424 SANIA 4

wall light; aluminium, satin nickel  
Wandleuchte; Alu, nickel-matt  
Applique; aluminium, nickel mat

L 130, H 80, A 90



6W 670lm



9 002759 984243

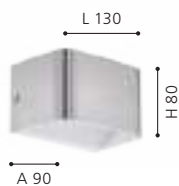

### 98425 SANIA 4

wall light; aluminium, satin nickel  
Wandleuchte; Alu, nickel-matt  
Applique; aluminium, nickel mat

L 200, H 80, A 90



10W 1300lm



9 002759 984250

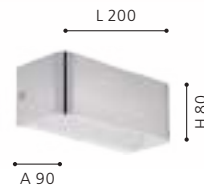

### 98426 SANIA 4

wall light; aluminium, satin nickel  
Wandleuchte; Alu, nickel-matt  
Applique; aluminium, nickel mat

L 365, H 80, A 90



12W 1400lm



9 002759 984267

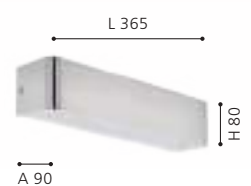

DESIGN  
HIGHLIGHT  
DETAIL



96261

LED



96264

LED

### 96261 PASSA

wall light; steel, satin nickel, chrome  
Wandleuchte; Stahl, nickel-matt, chrom  
Applique; acier, nickel mat, chrome

L 60, H 170, A 85



GU10



2x 3W



warm  
WHITE  
2x  
250lm



9 002759 962616



### 96264 PASSA

wall light; steel, satin nickel, chrome  
Wandleuchte; Stahl, nickel-matt, chrom  
Applique; acier, nickel mat, chrome

L 55, H 170, A 85



GU10



2x 3W



warm  
WHITE  
2x  
250lm



9 002759 962647





95368

LED



95377

LED

### 95368 PASSA

wall light; steel, chrome, white  
Wandleuchte; Stahl, chrom, weiss  
Applique; acier, chrome, blanc

L 60, H 170, A 85



GU10



2x 3W



warm  
WHITE  
2x  
250lm



9 002759 953683



INCL.



### 95377 PASSA

wall light; steel, chrome, white  
Wandleuchte; Stahl, chrom, weiss  
Applique; acier, chrome, blanc

L 55, H 170, A 85



GU10



2x 3W



warm  
WHITE  
2x  
250lm



9 002759 953775



INCL.





95371

LED



95379

LED

### 95371 PASSA

wall light; steel, brown, copper  
Wandleuchte; Stahl, braun, kupfer  
Applique; acier, marron, cuivre

L 60, H 170, A 85

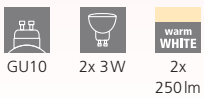

### 95379 PASSA

wall light; steel, brown, copper  
Wandleuchte; Stahl, braun, kupfer  
Applique; acier, marron, cuivre

L 55, H 170, A 85

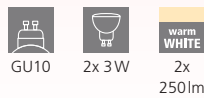

### 95364 PASSA

wall light; steel, black, gold  
Wandleuchte; Stahl, schwarz, gold  
Applique; acier, noir, or

L 60, H 170, A 85





95364

LED



95373

LED

### 95373 PASSA

wall light; steel, black, gold  
Wandleuchte; Stahl, schwarz, gold  
Applique; acier, noir, or

L 55, H 170, A 85



GU10



2x 3W



warm  
WHITE  
2x  
250lm



9 002759 953737



INCL.

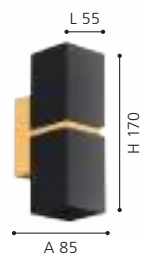



98379



98755



98759

### 98379 GASCUERIA

wall light; plastic, steel, gold, black  
Wandleuchte; Kunststoff, Stahl, gold, schwarz  
Applique; plastique, acier, or, noir

L 290, H 330, A 130



E27



1x 60W



L 290



H 330

A 130



9 002759 983796

### 98755 ELIZONDO

wall light; steel, black, gold  
Wandleuchte; Stahl, schwarz, gold  
Applique; acier, noir, or

L 80, H 270, A 115



E14



1x 40W



L 80

H 270

A 115



9 002759 987558

### 98759 FALICETTO

wall light; steel, black, gold  
Wandleuchte; Stahl, schwarz, gold  
Applique; acier, noir, or

L 160, H 250, A 115



E27



1x 40W



L 160

H 250

A 115



9 002759 987596



**900375**

**900375 HAYES**

wall light; steel, black, gold  
 Wandleuchte; Stahl, schwarz, gold  
 Applique; acier, noir, or

L 120, H 225, A 120



E27



1x 40W



**900375**

The golden element of the luminaires can be rotated. This allows the light to be individually adjusted.

Das goldenen Element der Leuchten ist drehbar. Dadurch lässt sich der Lichtschein individuell anpassen.

L'élément doré du luminaires peut être tourné. Cela permet de régler la lumière individuellement.



**900343**



**900518**

### 900343 TANURA

wall light; steel, black  
Wandleuchte; Stahl, schwarz  
Applique; acier, noir

L 245, H 110, A 105



E27



1x 25W



9 008606 243495

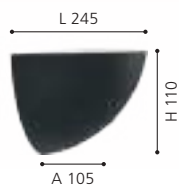

### 900518 GUANAL

wall light; aluminium, steel, chrome  
Wandleuchte; Alu, Stahl, chrom  
Applique; aluminium, acier, chrome

L 600, B 50, H 60



E27



4x 40W



9 008606 244478



### 900517 GUANAL

wall light; aluminium, steel, black  
Wandleuchte; Alu, Stahl, schwarz  
Applique; aluminium, acier, noir

L 600, B 50, H 60



E27



4x 40W



9 008606 244461







900517



30658



30659



33941



### 30658 CADEGAL

ceiling light; steel, black / plastic, white  
 Deckenleuchte; Stahl, schwarz / Kunststoff, weiss  
 plafonnier; acier, noir / plastique, blanc

L 200, B 200, H 50



7,8W 1200lm

### 30659 CADEGAL

ceiling light; steel, black / plastic, white  
 Deckenleuchte; Stahl, schwarz / Kunststoff, weiss  
 plafonnier; acier, noir / plastique, blanc

H 50, Ø 200



7,8W 1100lm

### 33941 CADEGAL

ceiling light; steel, white / plastic, white  
 Deckenleuchte; Stahl, weiss / Kunststoff, weiss  
 plafonnier; acier, blanc / plastique, blanc

L 200, B 200, H 50



7,8W 1200lm



9 002759 306588

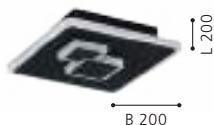

9 002759 306595



9 002759 339418





33942

LED



33964

LED



### 33942 CADEGAL

ceiling light; steel, white / plastic, white  
Deckenleuchte; Stahl, weiss / Kunststoff, weiss  
plafonnier; acier, blanc / plastique, blanc

H 50, Ø 200



7,8W 1100lm

### 33964 REMIDOS

ceiling light; steel, white / plastic, white  
Deckenleuchte; Stahl, weiss / Kunststoff, weiss  
plafonnier; acier, blanc / plastique, blanc

H 90, Ø 400

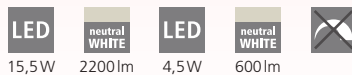

15,5W 2200lm 4,5W 600lm





98888



96037



96038



### 98888 METRASS

wall light; aluminium, black / plastic, satin finish  
Wandleuchte; Alu, schwarz / Kunststoff, satiniert  
Applique; aluminium, noir / plastique, satiné

L 200, H 105, A 60



1x 5,6W 680lm

### 96037 METRASS

wall light; aluminium, white / plastic, satin finish  
Wandleuchte; Alu, weiss / Kunststoff, satiniert  
Applique; aluminium, blanc / plastique, satiné

L 200, H 105, A 60



1x 5,6W 680lm

### 96038 METRASS

wall light; aluminium, satin nickel / plastic, satin finish  
Wandleuchte; Alu, nickel-matt / Kunststoff, satiniert  
Applique; aluminium, nickel mat / plastique, satiné

L 200, H 105, A 60



1x 5,6W 680lm



9 002759 988883



9 002759 960377



9 002759 960384





96042



96043



### 96042 METRASS 2

wall/ceiling light; aluminium, white / plastic, satin finish  
Wand- / Deckenleuchte; Alu, weiss / Kunststoff, satiniert  
Applique/Plafonnier; aluminium, blanc / plastique, satiné

L 170, H 200, A 55



2x 4,5W 960lm



9 002759 960421

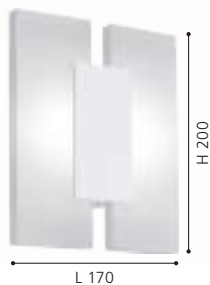

### 96043 METRASS 2

wall/ceiling light; aluminium, satin nickel / plastic, satin finish  
Wand- / Deckenleuchte; Alu, nickel-matt / Kunststoff, satiniert  
Applique/Plafonnier; aluminium, nickel mat / plastique, satiné

L 170, H 200, A 55



2x 4,5W 960lm



9 002759 960438





96039





96041

LED

### 96039 METRASS 1

wall light; aluminium, white / plastic, satin finish  
 Wandleuchte; Alu, weiss / Kunststoff, satiniert  
 Applique; aluminium, blanc / plastique, satiné

L 130, H 130, A 50



1x 4,5W 480lm



9 002759 960391

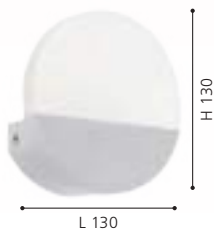

### 96041 METRASS 1

wall light; aluminium, satin nickel / plastic, satin finish  
 Wandleuchte; Alu, nickel-matt / Kunststoff, satiniert  
 Applique; aluminium, nickel mat / plastique, satiné

L 130, H 130, A 50



1x 4,5W 480lm



9 002759 960414





99606



99607



99609



### 99606 SARGINTO

wall/ceiling light; steel, white / plastic, white  
Wand- / Deckenleuchte; Stahl, weiss / Kunststoff, weiss  
Applique/Plafonnier; acier, blanc / plastique, blanc

L 590, B 140, H 45

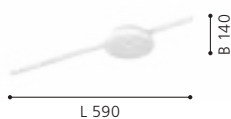

### 99607 SARGINTO

wall/ceiling light; steel, white / plastic, white  
Wand- / Deckenleuchte; Stahl, weiss / Kunststoff, weiss  
Applique/Plafonnier; acier, blanc / plastique, blanc

L 590, B 130, H 45

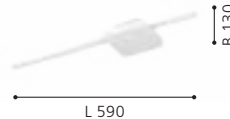
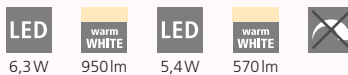

### 99609 SARGINTO

wall/ceiling light; steel, black / plastic, white  
Wand- / Deckenleuchte; Stahl, schwarz / Kunststoff, weiss  
Applique/Plafonnier; acier, noir / plastique, blanc

L 590, B 130, H 45

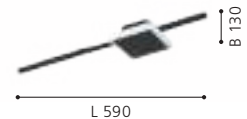





99608

LED

### 99608 SARGINTO

wall/ceiling light; steel, black / plastic, white  
 Wand- / Deckenleuchte; Stahl, schwarz / Kunststoff, weiss  
 Applique/Plafonnier; acier, noir / plastique, blanc

L 590, B 140, H 45

				
6,3W	950lm	5,4W	570lm	



9 002759 996086



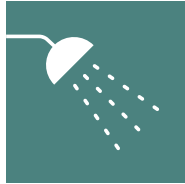

# BATH & MIRROR LUMINAIRES

BAD- & SPIEGELLEUCHTEN  
LUMINAIRES DE BAIN & MIROIR



**EN PURE RELAXATION**

Turn your bathroom into your personal wellness oasis. Trendy bathroom and mirror luminaires give a pleasant light and ensure relaxation and comfort.

**DE ENTSPANNUNG PUR**

Verwandeln Sie Ihr Badezimmer in eine persönliche Wohlfühloase. Trendige Bad- und Spiegelleuchten spenden ein angenehmes Licht und sorgen für Entspannung und Ihr Wohlbefinden.

**FR DE LA PURE DÉTENTE**











































Transformez votre salle de bains en un îlot personnel de bien-être. Des éclairages à la mode de miroirs et de bain confèrent une lumière agréable et vous assurent de la détente et du bien-être.





# OVERVIEW

BATH & MIRROR LUMINAIRES  
BAD- & SPIEGELLEUCHTEN  
LUMINAIRES DE BAIN & MIROIR

 AMEZOLA 620	 SAN PERI 1 621	 TAMARA 1 622-623	 ALMONTE 624	 TOLIRICO 626	 PALMITAL 628-629	 MOSIANO 630	 BARI-M 630	
 FRANIA 631-632	 FRANIA-S 631, 633	 WASAO 1 632	 MANILVA 1 632	 PINETTO 634-635	 LED PALERMO 634-635	 LED CARPI 636-637	 FUEVA 5 638-646	
 ROMENDO 1 648-649	 SIDERNO 650	 SANIA 5 650-651	 PEGUERA 653	 VERDELLO 653-654	 GEMILIANA 654-655	 ALCUDIA 656	 CALNOVA 657	
 TORRETTA 657	 TRAGACETE 1 658-659	 GITA 2 660	 TABIANO 663	 CABUS 663	 VADUMI 664	 PANDELLA 2 666, 670	 PANDELLA 1 666-669	
 VINCHIO 670	 PALMERA 672	 ZOLA 672	 BARI 1 673	 STICKER 673	 BUENAVISTA 674	 BUENAVISTA 1 676	 BUENAVISTA 2 676-677	
 TABIANO-Z 44	 FUEVA-Z 76-87	 TOTARI-Z 88	Bath & mirror lights can also be found in the EGLO connect.Z chapter. Bad- und Spiegelleuchten finden Sie auch im Kapitel EGLO connect.Z. Les luminaires de bain & miroir se trouvent également dans le chapitre EGLO connect.Z.					



This product is available in different colors and shapes. / Dieser Artikel ist in unterschiedlichen Farben und Formen verfügbar. / Cet article est disponible en différentes couleurs et formes.





AMEZOLA

99123



IP44



99122



IP44

### 99122 AMEZOLA

wall/ceiling light; steel, black / glass, clear  
Wand- / Deckenleuchte; Stahl, schwarz / Glas, klar  
Applique/Plafonnier; acier, noir / verre, transparent

L 290, H 290, A 130



E27



2x 28W



IP44



9 002759 991227



### 99123 AMEZOLA

wall light; steel, black / glass, clear  
Wandleuchte; Stahl, schwarz / Glas, klar  
Applique; acier, noir / verre, transparent

L 110, H 260, A 100



E27



1x 40W



IP44



9 002759 991234



### 99124 AMEZOLA

wall light; steel, black / glass, clear  
Wandleuchte; Stahl, schwarz / Glas, klar  
Applique; acier, noir / verre, transparent

L 110, H 380, A 100



E27



2x 60W



IP44



9 002759 991241





99124



IP44



900428

LED



IP44

### 900428 SAN PERI 1

wall light; steel, black, white  
Wandleuchte; Stahl, schwarz, weiss  
Applique; acier, noir, blanc

L 130, H 180, A 160



GU10



1x 3W



warm  
WHITE  
1x  
240lm



IP44



9 008606 243877

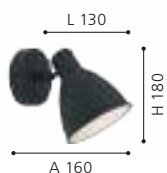



95994



IP44



95993



IP44



95995



IP44

### 95993 TAMARA 1

spot; steel, glass, white, chrome  
Spot; Stahl, Glas, weiss, chrom  
spot; acier, verre, blanc, chrome

L 120, B 120



GU10



1x 3W



warm  
WHITE

1x  
240lm



IP44



### 95994 TAMARA 1

spot; steel, glass, white, chrome  
Spot; Stahl, Glas, weiss, chrom  
spot; acier, verre, blanc, chrome

L 460, B 70



GU10



3x 3W



warm  
WHITE

3x  
240lm



IP44



### 95995 TAMARA 1

spot; steel, glass, white, chrome  
Spot; Stahl, Glas, weiss, chrom  
spot; acier, verre, blanc, chrome

L 240, B 260



GU10



4x 3W



warm  
WHITE

4x  
240lm



IP44



9 002759 959937



L 120

B 120



9 002759 959944



L 460

B 70



9 002759 959951



L 240

B 260





33677

LED



IP44



33678

LED



IP44

### 33677 TAMARA 1

spot; steel, black, chrome / glass, clear  
Spot; Stahl, schwarz, chrom / Glas, klar  
spot; acier, noir, chrome / verre, transparent

L 120, B 120



GU10



1x 3W



1x  
warm  
WHITE  
240lm



IP44



### 33678 TAMARA 1

spot; steel, black, chrome / glass, clear  
Spot; Stahl, schwarz, chrom / Glas, klar  
spot; acier, noir, chrome / verre, transparent

L 240, B 260



GU10



4x 3W



4x  
warm  
WHITE  
240lm



IP44



9 002759 336776



L 120

B 120



9 002759 336783



L 240

B 260

DESIGN  
HIGHLIGHT  
DETAIL



94879

LED



IP44



97699

LED



IP44

### 94879 ALMONTE

wall light; steel, chrome / brilliant glass, clear  
Wandleuchte; Stahl, chrom / Brillantglas, klar  
Applique; acier, chrome / verre brillant, transparent

L 110, H 230, A 170



G9

1x 3W

1x  
320lm

IP44



9 002759 948795



A 170

### 97699 ALMONTE

ceiling light; steel, chrome / brilliant glass, clear  
Deckenleuchte; Stahl, chrom / Brillantglas, klar  
plafonnier; acier, chrome / verre brillant, transparent

H 300, Ø 500



G9

8x 3W

8x  
320lm

IP44



9 002759 976996

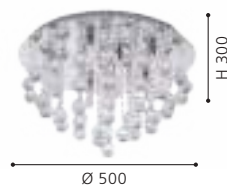

Ø 500

### 94878 ALMONTE

ceiling light; steel, chrome / brilliant glass, clear  
Deckenleuchte; Stahl, chrom / Brillantglas, klar  
plafonnier; acier, chrome / verre brillant, transparent

H 230, Ø 350



G9

4x 3W

4x  
320lm

IP44



9 002759 948788

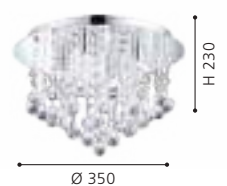

Ø 350



94878

LED



IP44





## TOLORICO

These luminaires come with high quality brilliant glass.

Diese Leuchten sind mit hochwertigem Brillantglas ausgestattet.

Ces lumières sont fabriquées avec une haute qualité Equipé de verre brillant.



97054

LED



IP44



97055

LED



IP44

### 97054 TOLORICO

wall/ceiling light; stainless steel, chrome / plastic, brilliant glass, clear

Wand- / Deckenleuchte; Edelstahl, chrom / Kunststoff, Brillantglas, klar

Applique/Plafonnier; acier inoxydable, chrome / plastique, verre brillant, transparent  
L 350, B 100, H 70



8W



1000lm



IP44



### 97055 TOLORICO

wall/ceiling light; stainless steel, chrome / plastic, brilliant glass, clear

Wand- / Deckenleuchte; Edelstahl, chrom / Kunststoff, Brillantglas, klar

Applique/Plafonnier; acier inoxydable, chrome / plastique, verre brillant, transparent  
L 570, B 100, H 75



20,5W



2700lm



IP44



### 97056 TOLORICO

wall/ceiling light; stainless steel, chrome / plastic, brilliant glass, clear

Wand- / Deckenleuchte; Edelstahl, chrom / Kunststoff, Brillantglas, klar

Applique/Plafonnier; acier inoxydable, chrome / plastique, verre brillant, transparent  
L 350, B 350, H 75



22W



3000lm



IP44



9 002759 970543



9 002759 970550



9 002759 970567





97056

LED



IP44





97965



IP44

### 97965 PALMITAL

wall/ceiling light; aluminium, steel, chrome / plastic, clear  
Wand- / Deckenleuchte; Alu, Stahl, chrom / Kunststoff, klar  
Applique/Plafonnier; aluminium, acier, chrome / plastique,  
transparent

L 880, B 100, H 90



2x 11 W



2700lm



IP44



9 002759 979652





900844



IP44



97966



IP44



900845



IP44

### 900844 PALMITAL

wall/ceiling light; aluminium, steel, black / plastic, satin finish  
Wand- / Deckenleuchte; Alu, Stahl, schwarz / Kunststoff, satiniert  
Applique/Plafonnier; aluminium, acier, noir / plastique, satiné

L 880, B 100, H 90



2x 11 W 2700lm

### 97966 PALMITAL

wall light; aluminium, steel, chrome / plastic, clear  
Wandleuchte; Alu, Stahl, chrom / Kunststoff, klar  
Applique; aluminium, acier, chrome / plastique, transparent

L 595, H 80, A 65



1x 11 W 1350lm

### 900845 PALMITAL

wall light; aluminium, steel, black / plastic, satin finish  
Wandleuchte; Alu, Stahl, schwarz / Kunststoff, satiniert  
Applique; aluminium, acier, noir / plastique, satiné

L 595, H 80, A 65



1x 11 W 1350lm



9 008606 259762



L 880



9 002759 979669



L 595



9 008606 259779



L 595



94626

LED



IP44



97531



97531



IP44

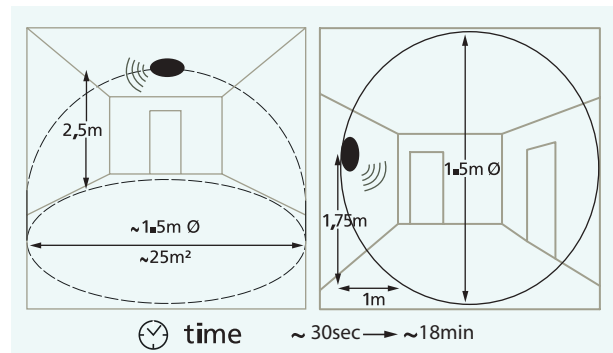

97531

These luminaires are equipped with an integrated motion sensor. The sensor is invisibly mounted behind the glass.

Diese Leuchten sind mit einem integrierten Bewegungssensor ausgestattet. Der Sensor ist unsichtbar hinter dem Glas befestigt.

Ces luminaires sont équipés d'un capteur de mouvement intégré. Le capteur est fixé de manière invisible derrière le verre.

### 94626 MOSIANO

wall/ceiling light; stainless steel, chrome / matte-opal glass, white

Wand- / Deckenleuchte; Edelstahl, chrom / Glas opal-matt, weiss

Applique/Plafonnier; acier inoxydable, chrome / verre opale mat, blanc

H 115, Ø 110



1x 3,3W



340 lm



IP44



### 97531 BARI-M

ceiling light; plastic, white / glass, white

Deckenleuchte; Kunststoff, weiss / Glas, weiss

plafonnier; plastique, blanc / verre, blanc

H 110, Ø 275



E27



1x 20W



IP44



9 002759 946265



9 002759 975319







97884



IP44



900363



IP44



900619



IP44

### 97884 FRANIA

wall/ceiling light; steel, white / plastic, white  
Wand- / Deckenleuchte; Stahl, weiss / Kunststoff, weiss  
Applique/Plafonnier; acier, blanc / plastique, blanc

H 70, Ø 330



14,6W



1600lm



IP44

### 900363 FRANIA-S

wall/ceiling light; steel, white / plastic with crystal effect, white  
Wand- / Deckenleuchte; Stahl, weiss / Kunststoff m.Kristalleffekt, weiss  
Applique/Plafonnier; acier, blanc / plastique avec effet cristal, blanc

H 55, Ø 310



18W



1850lm



IP44

### 900619 FRANIA-S

wall/ceiling light; steel, white / plastic with crystal effect, white  
Wand- / Deckenleuchte; Stahl, weiss / Kunststoff m.Kristalleffekt, weiss  
Applique/Plafonnier; acier, blanc / plastique avec effet cristal, blanc

H 55, Ø 310



15W



1800lm



IP44



9 002759 978846



Ø 330



9 008606 234455



Ø 310



9 008606 245161



Ø 310



94884



IP44



96229



IP44

### 94884 WASAO 1

wall/ceiling light; stainless steel, chrome / painted glass, white  
Wand- / Deckenleuchte; Edelstahl, chrom / Glas lackiert, weiss  
Applique/Plafonnier; acier inoxydable, chrome / verre laqué, blanc

L 320, B 320, H 60



4x 5,4W 2040lm

### 96229 MANILVA 1

wall light; steel, chrome / plastic, white  
Wandleuchte; Stahl, chrom / Kunststoff, weiss  
Applique; acier, chrome / plastique, blanc

L 290, B 290, H 70



2x 5,4W 1100lm 2x 2,6W 660lm



IP44

### 97885 FRANIA

wall/ceiling light; steel, white / plastic, white  
Wand- / Deckenleuchte; Stahl, weiss / Kunststoff, weiss  
Applique/Plafonnier; acier, blanc / plastique, blanc

L 330, B 330, H 70



14,6W 1600lm



9 002759 948849



L 320



9 002759 962296

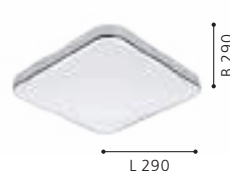

L 290



9 002759 978853



L 330



97885



900364



### 900364 FRANIA-S

wall/ceiling light; steel, white / plastic with crystal effect, white  
Wand- / Deckenleuchte; Stahl, weiss / Kunststoff m.Kristalleffekt, weiss  
Applique/Plafonnier; acier, blanc / plastique avec effet cristal, blanc

L 330, B 330, H 70



14,6W 1600lm



9 008606 234462





900846



IP44



900366



IP44

### 900366 PINETTO

wall/ceiling light; steel, white / plastic, white, black  
Wand- / Deckenleuchte; Stahl, weiss / Kunststoff, weiss, schwarz  
Applique/Plafonnier; acier, blanc / plastique, blanc, noir

H 65, Ø 340



15,6W



1900lm



IP44

### 900846 LED PALERMO

wall/ceiling light; steel, black / satin glass, white painted  
Wand- / Deckenleuchte; Stahl, schwarz / Glas satiniert, weiss lackiert  
Applique/Plafonnier; acier, noir / verre satiné, blanc laqué

H 75, Ø 300



3x 5,7W



2100lm



IP44

DESIGN  
HIGHLIGHT  
DETAIL



9 008606 235971



9 008606 259786





94999



IP44



900365



IP44



94998



IP44

### 900365 PINETTO

wall/ceiling light; steel, white / plastic, white, chrome  
Wand- / Deckenleuchte; Stahl, weiss / Kunststoff, weiss, chrom  
Applique/Plafonnier; acier, blanc / plastique, blanc, chrome

H 65, Ø 340



15,6W 1900lm

### 94998 LED PALERMO

wall/ceiling light; steel, chrome / satin glass, white painted  
Wand- / Deckenleuchte; Stahl, chrom / Glas satiniert, weiss lackiert  
Applique/Plafonnier; acier, chrome / verre satiné, blanc laqué

H 60, Ø 225



3x 3,6W 1110lm

### 94999 LED PALERMO

wall/ceiling light; steel, chrome / satin glass, white painted  
Wand- / Deckenleuchte; Stahl, chrom / Glas satiniert, weiss lackiert  
Applique/Plafonnier; acier, chrome / verre satiné, blanc laqué

H 75, Ø 300



3x 5,7W 2100lm



9 008606 235964

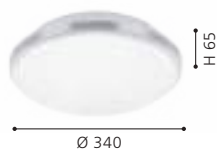

9 002759 949983



9 002759 949990





33682



IP44



95282



IP44



900369



IP44

### 33682 LED CARPI

wall/ceiling light; steel, black, white / plastic, white  
Wand- / Deckenleuchte; Stahl, schwarz, weiss / Kunststoff, weiss  
Applique/Plafonnier; acier, noir, blanc / plastique, blanc

Ø 300, A 75



3x 3,6W

960lm

IP44

### 900369 LED CARPI

ceiling light; steel, brushed brass, white / plastic, white  
Deckenleuchte; Stahl, messing-gebürstet, weiss / Kunststoff, weiss  
plafonnier; acier, laiton brossé, blanc / plastique, blanc

Ø 300, A 75



3x 3,6W

1110lm

IP44

### 95282 LED CARPI

wall/ceiling light; steel, white, chrome / plastic, white  
Wand- / Deckenleuchte; Stahl, weiss, chrom / Kunststoff, weiss  
Applique/Plafonnier; acier, blanc, chrome / plastique, blanc

Ø 300, A 75



3x 3,6W

960lm

IP44



9 002759 336820



Ø 300



9 008606 240623



Ø 300



9 002759 952822



Ø 300



95283

LED



IP44



### 95283 LED CARPI

wall/ceiling light; steel, white, chrome / plastic, white  
Wand- / Deckenleuchte; Stahl, weiss, chrom / Kunststoff, weiss  
Applique/Plafonnier; acier, blanc, chrome / plastique, blanc

Ø 385, A 75

LED

warm  
WHITE



3x 7,3 W

2220 lm

IP44



Ø 385

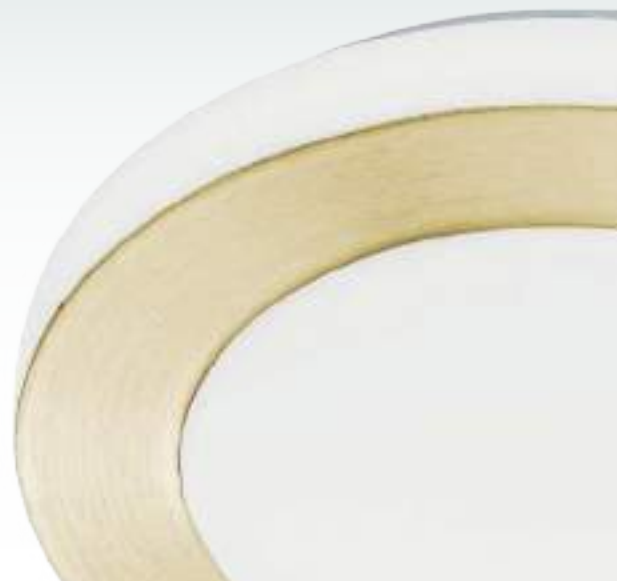

## FUEVA 5

These luminaires are protected against splash water.

Diese Leuchten sind gegen Spritzwasser geschützt.

Les luminaires sont protégées contre les éclaboussures d'eau.



IP44

	0	1	2	3
EU	X	X	✓	✓
FR	X	X	X	✓



99202



IP44

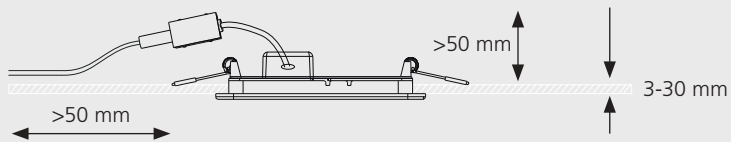

## FUEVA 5

Slim design and minimal installation depth. This makes it ideal for ceiling constructions with little space. Easy installation / replacement of the lights with practical connectors.

Schlanke Bauform und minimale Einbautiefe. Dadurch ideal für Deckenkonstruktionen mit wenig Platz. Einfache Montage / Austausch der Leuchten durch praktischen Verbinder.

Conception mince et profondeur d'installation minimale. Cela le rend idéal pour les constructions de plafond avec peu d'espace. Installation / remplacement facile des lumières avec des connecteurs pratiques.

### 99202 FUEVA 5

recessed light; steel, white / plastic, white  
Einbauleuchte; Stahl, weiss / Kunststoff, weiss  
luminaire encastrable; acier, blanc / plastique, blanc

Ø 86, ET 26



Ø 86

### 99203 FUEVA 5

recessed light; steel, white / plastic, white  
Einbauleuchte; Stahl, weiss / Kunststoff, weiss  
luminaire encastrable; acier, blanc / plastique, blanc

Ø 166, ET 26



Ø 166

### 99206 FUEVA 5

recessed light; steel, white / plastic, white  
Einbauleuchte; Stahl, weiss / Kunststoff, weiss  
luminaire encastrable; acier, blanc / plastique, blanc

Ø 86, ET 26



Ø 86





99203

LED



IP44



99206

LED



IP44



99207

LED



IP44

### 99207 FUEVA 5

recessed light; steel, white / plastic, white  
Einbauleuchte; Stahl, weiss / Kunststoff, weiss  
luminaire encastrable; acier, blanc / plastique, blanc

Ø 166, ET 26



11W



1350lm



Ø 155



IP44



9 002759 992071



Ø 166

## FUEVA 5

These luminaires are protected against splash water.

Diese Leuchten sind gegen Spritzwasser geschützt.

Les luminaires sont protégées contre les éclaboussures d'eau.



IP44

	0	1	2	3
EU	X	X	✓	✓
FR	X	X	X	✓



99208



IP44



99209



IP44

## FUEVA 5

Slim design and minimal installation depth. This makes it ideal for ceiling constructions with little space. Easy installation / replacement of the lights with practical connectors.

Schlanke Bauform und minimale Einbautiefe. Dadurch ideal für Deckenkonstruktionen mit wenig Platz. Einfache Montage / Austausch der Leuchten durch praktischen Verbinder.

Conception mince et profondeur d'installation minimale. Cela le rend idéal pour les constructions de plafond avec peu d'espace. Installation / remplacement facile des lumières avec des connecteurs pratiques.

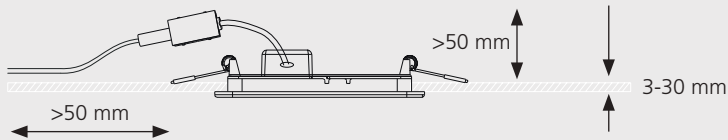

### 99208 FUEVA 5

recessed light; steel, chrome / plastic, white  
Einbauleuchte; Stahl, chrom / Kunststoff, weiss  
luminaire encastrable; acier, chrome / plastique, blanc

Ø 86, ET 26



2,7W



330lm



Ø 75



IP44



9 002759 992088



Ø 86

### 99209 FUEVA 5

recessed light; steel, chrome / plastic, white  
Einbauleuchte; Stahl, chrom / Kunststoff, weiss  
luminaire encastrable; acier, chrome / plastique, blanc

Ø 166, ET 26



11W



1350lm



Ø 155



IP44



9 002759 992095



Ø 166

### 99205 FUEVA 5

recessed light; steel, chrome / plastic, white  
Einbauleuchte; Stahl, chrom / Kunststoff, weiss  
luminaire encastrable; acier, chrome / plastique, blanc

Ø 166, ET 26



11W



1350lm



Ø 155



IP44



9 002759 992057



Ø 166



99205



IP44



99204



IP44

### 99204 FUEVA 5

recessed light; steel, chrome / plastic, white

Einbauleuchte; Stahl, chrom / Kunststoff, weiss

luminaire encastrable; acier, chrome / plastique, blanc

Ø 86, ET 26



2,7W



330lm



Ø 75



IP44



9 002759 992040



Ø 86

## FUEVA 5

These luminaires are protected against splash water.

Diese Leuchten sind gegen Spritzwasser geschützt.

Les luminaires sont protégées contre les éclaboussures d'eau.



IP44

	0	1	2	3
EU	X	X	✓	✓
FR	X	X	X	✓



99213



IP44



99214



IP44

## FUEVA 5

Slim design and minimal installation depth. This makes it ideal for ceiling constructions with little space. Easy installation / replacement of the lights with practical connectors.

Schlanke Bauform und minimale Einbautiefe. Dadurch ideal für Deckenkonstruktionen mit wenig Platz. Einfache Montage / Austausch der Leuchten durch praktischen Verbinder.

Conception mince et profondeur d'installation minimale. Cela le rend idéal pour les constructions de plafond avec peu d'espace. Installation / remplacement facile des lumières avec des connecteurs pratiques.

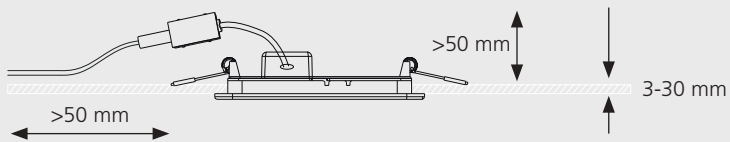

### 99213 FUEVA 5

recessed light; steel, black / plastic, white  
Einbauleuchte; Stahl, schwarz / Kunststoff, weiss  
luminaire encastrable; acier, noir / plastique, blanc

Ø 86, ET 26



2,7W

330lm

Ø 75

IP44



9 002759 992132



Ø 86

### 99214 FUEVA 5

recessed light; steel, black / plastic, white  
Einbauleuchte; Stahl, schwarz / Kunststoff, weiss  
luminaire encastrable; acier, noir / plastique, blanc

Ø 166, ET 26



11W

1350lm

Ø 155

IP44



9 002759 992149



Ø 166

### 99212 FUEVA 5

recessed light; steel, black / plastic, white  
Einbauleuchte; Stahl, schwarz / Kunststoff, weiss  
luminaire encastrable; acier, noir / plastique, blanc

Ø 166, ET 26



11W

1350lm

Ø 155

IP44



9 002759 992125



Ø 166



99212

LED



IP44



99211

LED



IP44

### 99211 FUEVA 5

recessed light; steel, black / plastic, white  
Einbauleuchte; Stahl, schwarz / Kunststoff, weiss  
luminaire encastrable; acier, noir / plastique, blanc

Ø 86, ET 26

LED

2,7W

warm  
WHITE

330lm



Ø 75



IP44



Ø 86



99265



IP44



99267



IP44

### 99265 FUEVA 5

surface-mounted light; steel, white / plastic, white  
 Aufbauleuchte; Stahl, weiss / Kunststoff, weiss  
 luminaire en saillie; acier, blanc / plastique, blanc

H 28, Ø 285



20,5W



2400lm



IP44



### 99267 FUEVA 5

surface-mounted light; steel, black / plastic, white  
 Aufbauleuchte; Stahl, schwarz / Kunststoff, weiss  
 luminaire en saillie; acier, noir / plastique, blanc

H 28, Ø 285



20,5W



2400lm



IP44



### 99266 FUEVA 5

surface-mounted light; steel, chrome / plastic, white  
 Aufbauleuchte; Stahl, chrom / Kunststoff, weiss  
 luminaire en saillie; acier, chrome / plastique, blanc

H 28, Ø 285



20,5W



2400lm



IP44



9 002759 992651



9 002759 992675



9 002759 992668





99266

LED



IP44





99268



IP44



99271



IP44

### 99268 FUEVA 5

surface-mounted light; steel, white / plastic, white  
 Aufbauleuchte; Stahl, weiss / Kunststoff, weiss  
 luminaire en saillie; acier, blanc / plastique, blanc

L 285, B 285, H 30



20,5W 2400lm

### 99271 FUEVA 5

surface-mounted light; steel, black / plastic, white  
 Aufbauleuchte; Stahl, schwarz / Kunststoff, weiss  
 luminaire en saillie; acier, noir / plastique, blanc

L 285, B 285, H 30



20,5W 2400lm

### 99269 FUEVA 5

surface-mounted light; steel, chrome / plastic, white  
 Aufbauleuchte; Stahl, chrom / Kunststoff, weiss  
 luminaire en saillie; acier, chrome / plastique, blanc

L 285, B 285, H 30



20,5W 2400lm



9 002759 992682



L 285



9 002759 992712



L 285



9 002759 992699



L 285





99269

LED



IP44





96541



IP44



96542



IP44



96544



IP44

### 96541 ROMENDO 1

wall light; steel, chrome / plastic, clear, satin finish  
Wandleuchte; Stahl, chrom / Kunststoff, klar, satiniert  
Applique; acier, chrome / plastique, transparent, satiné

L 70, H 155, A 120



2x 7,2W 1080lm

### 96542 ROMENDO 1

wall light; steel, chrome / plastic, clear, satin finish  
Wandleuchte; Stahl, chrom / Kunststoff, klar, satiniert  
Applique; acier, chrome / plastique, transparent, satiné

L 300, H 70, A 125



2x 7,2W 1080lm

### 96544 ROMENDO 1

ceiling light; steel, chrome / plastic, clear, satin finish  
Deckenleuchte; Stahl, chrom / Kunststoff, klar, satiniert  
plafonnier; acier, chrome / plastique, transparent, satiné

L 320, B 320, H 70



5x 5,4W 3750lm



9 002759 965419



L 70

H 155



9 002759 965426



L 300

H 70



9 002759 965440



L 320

B 320



### ROMENDO 1

These luminaires are dimmable.

Diese Leuchten sind dimmbar.

Ces luminaires sont graduables.

### 96543 ROMENDO 1

wall light; steel, chrome / plastic, clear, satin finish  
Wandleuchte; Stahl, chrom / Kunststoff, klar, satiniert  
Applique; acier, chrome / plastique, transparent, satiné

L 450, H 70, A 125

LED

3x 7,2W

warm  
WHITE

3x  
570lm



IP44



96543

LED



IP44



97718



IP44



97719



IP44



99692



IP44

### 97718 SIDERNO

mirror light; steel, chrome / plastic, satin finish  
Spiegelleuchte; Stahl, chrom / Kunststoff, satiniert  
applique pour miroir; acier, chrome / plastique, satiné

L 350, B 60, A 55



8,3W



1000lm



IP44



### 97719 SIDERNO

mirror light; steel, chrome / plastic, satin finish  
Spiegelleuchte; Stahl, chrom / Kunststoff, satiniert  
applique pour miroir; acier, chrome / plastique, satiné

L 580, B 60, A 65



16W



1600lm



IP44



### 99692 SANIA 5

wall light; steel, satin nickel, white / plastic, satin finish  
Wandleuchte; Stahl, nickel-matt, weiss / Kunststoff, satiniert  
Applicque; acier, nickel mat, blanc / plastique, satiné

L 620, H 80, A 90



26,5W



3200lm



IP44



9 002759 977184



L 350

B 60



9 002759 977191



L 580

B 60



9 002759 996925

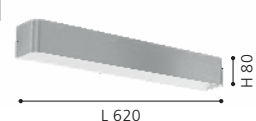

L 620

H 80



99691

LED



IP44

### 99691 SANIA 5

wall light; steel, black, white / plastic, satin finish  
Wandleuchte; Stahl, schwarz, weiss / Kunststoff, satiniert  
Applique; acier, noir, blanc / plastique, satiné

L 620, H 80, A 90

LED

26,5W

warm  
WHITE

3200lm



IP44



9 002759 996918





900929

LED



IP44



900928



IP44



900475



IP44

### 900929 PEGUERA

wall light; aluminium, steel, black, brushed brass / plastic, white  
Wandleuchte; Alu, Stahl, schwarz, messing-gebürstet / Kunststoff, weiss  
Applique; aluminium, acier, noir, laiton brossé / plastique, blanc

L 800, H 110, A 70



17,5W 2000lm



9 008606 274994

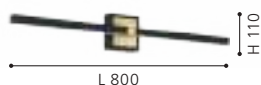

### 900928 PEGUERA

wall light; aluminium, steel, black, brushed brass / plastic, white  
Wandleuchte; Alu, Stahl, schwarz, messing-gebürstet / Kunststoff, weiss  
Applique; aluminium, acier, noir, laiton brossé / plastique, blanc

L 600, H 110, A 70



1x 11 W 1165lm



9 008606 274987



### 900475 VERDELLO

mirror light; plastic, black, brass / plastic, white  
Spiegelleuchte; Kunststoff, schwarz, messing / Kunststoff, weiss  
applique pour miroir; plastique, noir, laiton / plastique, blanc

L 600, B 60, H 105



5W 750lm



9 008606 244126

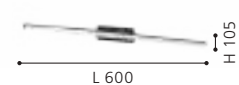

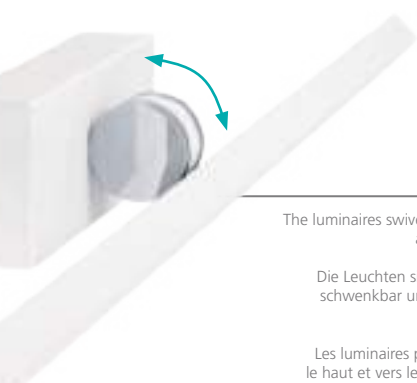

## VERDELLO

The luminaires swivel up and down and have a CCT switch on the side.

Die Leuchten sind nach oben und unten schwenkbar und haben einen seitlichen CCT-Schalter.

Les luminaires peuvent être orientés vers le haut et vers le bas et sont équipés d'un interrupteur CCT latéral.



900476



IP44



900616



IP44

### 900476 VERDELLO

mirror light; plastic, white, chrome / plastic, white  
Spiegelleuchte; Kunststoff, weiss, chrom / Kunststoff, weiss  
applique pour miroir; plastique, blanc, chrome / plastique, blanc

L 600, B 60, H 105



5W



750lm



IP44



9 008606 244133



### 900616 GEMILIANA

mirror light; steel, chrome / plastic, white  
Spiegelleuchte; Stahl, chrom / Kunststoff, weiss  
applique pour miroir; acier, chrome / plastique, blanc

L 450, H 40, A 100



8,9W



1000lm



IP44



9 008606 245130







## GEMILIANA

The LED profiles of these luminaires can be swivelled for direct or indirect light.

Die LED-Profilen dieser Leuchten sind schwenkbar für direktes oder indirektes Licht.

Les profilés LED de ces luminaires sont orientables pour un éclairage direct ou indirect.

### 900615 GEMILIANA

mirror light; steel, black / plastic, white  
Spiegelleuchte; Stahl, schwarz / Kunststoff, weiss  
applique pour miroir; acier, noir / plastique, blanc

L 450, H 40, A 100



8,9W



1000lm



IP44



9 008606 245123



900615

LED



IP44





**900618**

LED



IP44



**900617**

LED



IP44

### 900618 ALCUDIA

mirror light; aluminium, steel, chrome / plastic, satin finish  
Spiegelleuchte; Alu, Stahl, chrom / Kunststoff, satiniert  
applique pour miroir; aluminium, acier, chrome / plastique, satiné

L 420, H 30, A 60

LED

2x 5,5W

warm  
WHITE

1200lm



IP44



### 900617 ALCUDIA

mirror light; aluminium, steel, black / plastic, satin finish  
Spiegelleuchte; Alu, Stahl, schwarz / Kunststoff, satiniert  
applique pour miroir; aluminium, acier, noir / plastique, satiné

L 420, H 30, A 60

LED

2x 5,5W

warm  
WHITE

1200lm



IP44



9 008606 245154



9 008606 245147



## COLOUR RENDERING INDEX FARBWIEDERGABE-INDEX L'INDICE DE RESTITUTION DE COULEURS

The colour rendering index Ra describes the colour rendering quality of lamps. The higher the Ra value, the less will the artificial light change the colour of an object. The maximum Ra value (e.g. the Ra value of the sun) is 100. Therefore, lamps with an Ra above 90 will make you look more natural.

**CRI >90** This button indicates Lamps that have an Ra value of >90.

Mit dem Farbwiedergabe-Index Ra wird die Qualität der Farbwiedergabe von Leuchten beschrieben. Je höher der Ra-Wert ist, desto weniger verfälscht das künstliche Licht die Farbe von Objekten. Der maximale Ra-Wert (z.B. der Ra-Wert der Sonne) ist 100. Leuchten mit Ra >90 lassen Sie somit natürlicher aussehen.

**CRI >90** Dieser Button kennzeichnet Leuchten die einen Ra-Wert von >90 haben.

L'indice de restitution de couleurs Ra décrit la qualité de restitution des éclairages. Plus la valeur Ra est élevée, moins la lumière artificielle falsifie la couleur des objets. La valeur Ra maximale (par ex. la valeur Ra du soleil) est 100.

**CRI >90** Ce bouton signale les luminaires qui ont une valeur Ra >90.

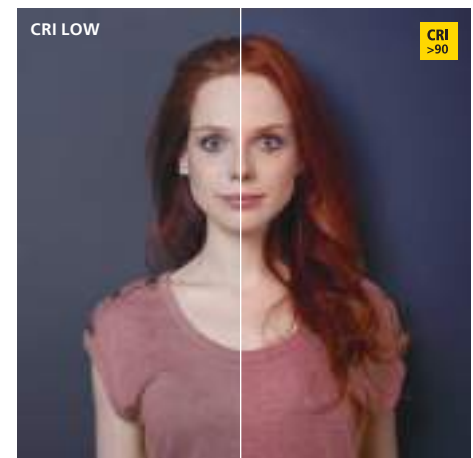

### 94716 CALNOVA

wall light; steel, satin nickel / satin glass, white  
Wandleuchte; Stahl, nickel-matt / Glas satiniert, weiss  
Applique; acier, nickel mat / verre satiné, blanc

L 600, B 50, A 85



**CRI >90**



### 94617 TORRETTA

mirror light; steel, satin nickel / plastic, white  
Spiegelleuchte; Stahl, nickel-matt / Kunststoff, weiss  
applique pour miroir; acier, nickel mat / plastique, blanc

L 600, B 40, A 75



**CRI >90**



## TRAGACETE 1

These luminaires refer to an on / off button directly on the luminaire.

Diese Leuchten verfügen über einen Ein-/Ausschaltknopf direkt an der Leuchte.

Ces luminaires se réfèrent à un bouton marche / arrêt directement sur le luminaire.



**99776**



IP44



**99777**



IP44



**99778**



IP44

### 99776 TRAGACETE 1

mirror light; plastic, steel, silver, chrome / plastic, white  
Spiegelleuchte; Kunststoff, Stahl, silber, chrom / Kunststoff, weiss

applique pour miroir; plastique, acier, argent, chrome / plastique, blanc

L 450, B 45, H 45



7,5W



900lm



IP44



9 002759 997762



### 99777 TRAGACETE 1

mirror light; plastic, steel, silver, chrome / plastic, white  
Spiegelleuchte; Kunststoff, Stahl, silber, chrom / Kunststoff, weiss

applique pour miroir; plastique, acier, argent, chrome / plastique, blanc

L 600, B 45, H 45



15,5W



1900lm



IP44



9 002759 997779



### 99778 TRAGACETE 1

mirror light; plastic, steel, silver, chrome / plastic, white  
Spiegelleuchte; Kunststoff, Stahl, silber, chrom / Kunststoff, weiss

applique pour miroir; plastique, acier, argent, chrome / plastique, blanc

L 770, B 45, H 45



18,5W



2600lm



IP44



9 002759 997786





99339

LED



IP44

### 99339 TRAGACETE 1

mirror light; aluminium, silver, chrome / plastic, white  
 Spiegelleuchte; Alu, silber, chrom / Kunststoff, weiss  
 applique pour miroir; aluminium, argent, chrome / plastique,  
 blanc

L 680, B 55, H 70

LED

15W

neutral  
 WHITE

1850lm



IP44



### 99339

These luminaires have a built-in socket.

Diese Leuchten verfügen über eine eingebaute Steckdose.

Ces luminaires disposent d'une prise de courant intégrée.



9 002759 993399





DESIGN  
HIGHLIGHT  
DETAIL



94712



IP44



94713



IP44

### 94712 GITA 2

wall/ceiling light; cast metal, chrome / plastic, white  
Wand- / Deckenleuchte; Metallguss, chrom / Kunststoff, weiss  
Applique/Plafonnier; fonte métallique, chrome / plastique, blanc

L 350, B 75, H 75



8,3W



1000lm



IP44



9 002759 947125



B 75

### 94713 GITA 2

wall/ceiling light; cast metal, chrome / plastic, white  
Wand- / Deckenleuchte; Metallguss, chrom / Kunststoff, weiss  
Applique/Plafonnier; fonte métallique, chrome / plastique, blanc

L 600, B 75, H 75



16W



1900lm



IP44



9 002759 947132



B 75

### 94714 GITA 2

wall/ceiling light; cast metal, chrome / plastic, white  
Wand- / Deckenleuchte; Metallguss, chrom / Kunststoff, weiss  
Applique/Plafonnier; fonte métallique, chrome / plastique, blanc

L 900, B 75, H 75



8,3W



850lm



16W



1600lm



IP44



9 002759 947149



B 75



94714

LED



IP44



94613

LED







94612



96937



IP44

### 94613 TABIANO

mirror light; steel, chrome / plastic, white  
Spiegelleuchte; Stahl, chrom / Kunststoff, weiss  
applique pour miroir; acier, chrome / plastique, blanc

L 605, H 70, A 130



3x 3,2W 900lm

### 94612 TABIANO

mirror light; steel, chrome / plastic, white  
Spiegelleuchte; Stahl, chrom / Kunststoff, weiss  
applique pour miroir; acier, chrome / plastique, blanc

L 405, H 70, A 130



2x 3,2W 600lm

### 96937 CABUS

wall light; steel, chrome / plastic, satin finish  
Wandleuchte; Stahl, chrom / Kunststoff, satiniert  
Applique; acier, chrome / plastique, satiné

L 450, H 45, A 115



3x 4,5W 1350lm



9 002759 946135

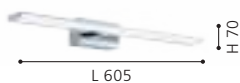

9 002759 946128



9 002759 969370

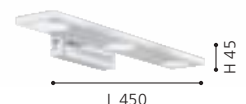

DESIGN  
HIGHLIGHT  
DETAIL



97081



IP44



97082



IP44

### 97081 VADUMI

wall light; plastic, chrome / plastic, white  
Wandleuchte; Kunststoff, chrom / Kunststoff, weiss  
Applique; plastique, chrome / plastique, blanc

L 400, H 50, A 125



7,4W



900lm



IP44



### 97082 VADUMI

wall light; plastic, chrome / plastic, white  
Wandleuchte; Kunststoff, chrom / Kunststoff, weiss  
Applique; plastique, chrome / plastique, blanc

L 600, H 50, A 125



11W



1350lm



IP44



### 97083 VADUMI

wall light; plastic, chrome / plastic, white  
Wandleuchte; Kunststoff, chrom / Kunststoff, weiss  
Applique; plastique, chrome / plastique, blanc

L 780, H 50, A 125



14W



1700lm



IP44



9 002759 970819



L 400

H 50



9 002759 970826



L 600

H 50



9 002759 970833



L 780

H 50



97083

LED



IP44





99731



IP44



98908



IP44



98677



IP44

### 99731 PANDELLA 2

mirror light; aluminium, plastic, black / plastic, white  
Spiegelleuchte; Alu, Kunststoff, schwarz / Kunststoff, weiss  
applique pour miroir; aluminium, plastique, noir / plastique, blanc

L 600, H 40, A 120



11W



1400lm



IP44



### 98908 PANDELLA 1

mirror light; aluminium, plastic, black / plastic, white  
Spiegelleuchte; Alu, Kunststoff, schwarz / Kunststoff, weiss  
applique pour miroir; aluminium, plastique, noir / plastique, blanc

L 600, H 40, A 120



11W



1350lm



IP44



### 98677 PANDELLA 1

mirror light; aluminium, plastic, black / plastic, white  
Spiegelleuchte; Alu, Kunststoff, schwarz / Kunststoff, weiss  
applique pour miroir; aluminium, plastique, noir / plastique, blanc

L 780, H 40, A 120



14W



1700lm



IP44



9 002759 997311



L 600

H 40



9 002759 989088



L 600

H 40



9 002759 986773

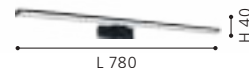

L 780

H 40

98907



IP44

DESIGN  
HIGHLIGHT  
DETAIL



### 98907 PANDELLA 1

mirror light; aluminium, plastic, black / plastic, white  
Spiegelleuchte; Alu, Kunststoff, schwarz / Kunststoff, weiss  
applique pour miroir; aluminium, plastique, noir / plastique, blanc

L 400, H 40, A 120



7,4W



900lm



IP44



9 002759 989071





96064



IP44



96065



IP44



96066



IP44

### 96064 PANDELLA 1

mirror light; aluminium, plastic, chrome, silver / plastic, white  
Spiegelleuchte; Alu, Kunststoff, chrom, silber / Kunststoff, weiss  
applique pour miroir; aluminium, plastique, chrome, argent /  
plastique, blanc

L 400, H 40, A 120



7,4W



900lm



IP44



### 96065 PANDELLA 1

mirror light; aluminium, plastic, chrome, silver / plastic, white  
Spiegelleuchte; Alu, Kunststoff, chrom, silber / Kunststoff, weiss  
applique pour miroir; aluminium, plastique, chrome, argent /  
plastique, blanc

L 600, H 40, A 120



11W



1350lm



IP44



### 96066 PANDELLA 1

mirror light; aluminium, plastic, chrome, silver / plastic, white  
Spiegelleuchte; Alu, Kunststoff, chrom, silber / Kunststoff, weiss  
applique pour miroir; aluminium, plastique, chrome, argent /  
plastique, blanc

L 780, H 40, A 120



14W



1700lm



IP44



9 002759 960643



9 002759 960650

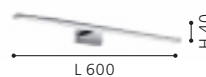

9 002759 960667

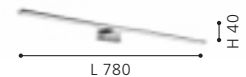



99297



IP44

### 99297 PANDELLA 1

mirror light; aluminium, plastic, chrome, silver / plastic, white  
Spiegelleuchte; Alu, Kunststoff, chrom, silber / Kunststoff, weiss  
applique pour miroir; aluminium, plastique, chrome, argent /  
plastique, blanc

L 1200, H 40, A 120



13,5W



1750lm



IP44



9 002759 992972

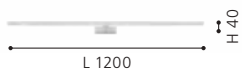



97059



IP44

### 97059

These luminaires are equipped with an integrated motion sensor. The sensor is invisibly mounted behind the housing.

Diese Leuchten sind mit einem integrierten Bewegungssensor ausgestattet. Der Sensor ist unsichtbar hinter dem Gehäuse befestigt.

Ces luminaires sont équipés d'un capteur de mouvement intégré. Le capteur est fixé de manière invisible derrière le boîtier.

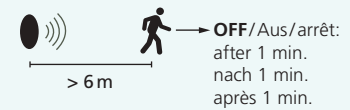
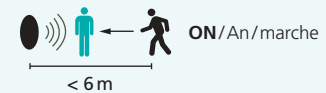
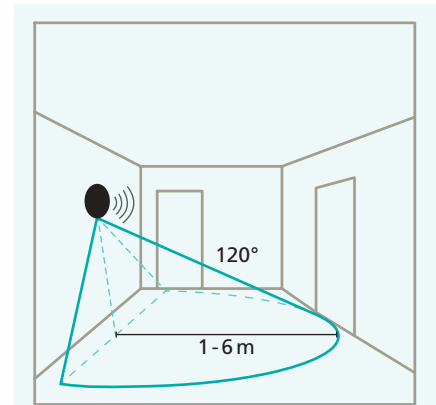

### VINCHIO

These luminaires are delivered with a wiring and connection box that is 19.5 mm deep.

Diese Leuchten werden mit einer Verkabelungs- und Anschlussbox mit einer Tiefe von 19,5 mm geliefert.

Cette luminaires sont livrés avec un boîtier de câblage et de connexion d'une profondeur de 19,5 mm.



98501



IP44

### 97059 PANDELLA 2

mirror light; plastic, silver, chrome / plastic, white  
Spiegelleuchte; Kunststoff, silber, chrom / Kunststoff, weiss  
applique pour miroir; plastique, argent, chrome / plastique, blanc

L 400, H 75, A 150



7,4W



900lm



IP44



9 002759 970598



### 98501 VINCHIO

mirror light; steel, chrome / plastic, white  
Spiegelleuchte; Stahl, chrom / Kunststoff, weiss  
applique pour miroir; acier, chrome / plastique, blanc

L 400, H 50, A 140



9W



1050lm



IP44



9 002759 985011



### 98502 VINCHIO

mirror light; steel, chrome / plastic, white  
Spiegelleuchte; Stahl, chrom / Kunststoff, weiss  
applique pour miroir; acier, chrome / plastique, blanc

L 600, H 50, A 140



13,6W



1600lm



IP44



9 002759 985028

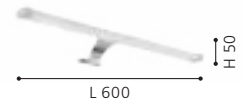





98502

LED



IP44



**87219**



IP44



**87222**



IP44



**83406**



83406 | 87219 | 87222

### 87219 PALMERA

wall light; steel, chrome / matte-opal glass, white  
Wandleuchte; Stahl, chrom / Glas opal-matt, weiss  
Applique; acier, chrome / verre opale mat, blanc

L 460, A 110



E14



2x 40W



IP44



9 002759 872199



L 460

### 87222 PALMERA

wall light; steel, satin nickel / matte-opal glass, white  
Wandleuchte; Stahl, nickel-matt / Glas opal-matt, weiss  
Applique; acier, nickel mat / verre opale mat, blanc

L 460, A 110



E14



2x 40W



IP44



9 002759 872229



L 460

### 83406 ZOLA

wall light; steel / matte-opal glass, white  
Wandleuchte; Stahl / Glas opal-matt, weiss  
Applique; acier / verre opale mat, blanc

L 390, B 80



E14



2x 40W



9 002759 834067

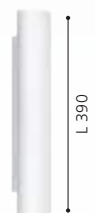

B 80

L 390



**94987**



**85832**

**94987 BARI 1**

mirror light; plastic, white / grooved glass, white  
Spiegelleuchte; Kunststoff, weiss / Glas gerillt, weiss  
applique pour miroir; plastique, blanc / verre rainuré, blanc

L 350, B 60, A 85



9 002759 949877



**85832 STICKER**

mirror light; steel, chrome / matte-opal glass, white  
Spiegelleuchte; Stahl, chrom / Glas opal-matt, weiss  
applique pour miroir; acier, chrome / verre opale mat, blanc

L 70, H 115, A 95



9 002759 858322



**94987**

These luminaires are equipped with an integrated socket.

Diese Leuchten sind mit einer integrierten Steckdose ausgestattet.

Ces luminaires sont équipés d'une prise de courant intégrée.



99774



IP44



99772



IP44

### 99774 BUENAVISTA

mirror light; aluminium, silver / mirror  
Spiegelleuchte; Alu, silber / Spiegel  
applique pour miroir; aluminium, argent / miroir

Ø 600, A 30



15,3W



1700lm



IP44



9 002759 997748



Ø 600

### 99772 BUENAVISTA

mirror light; aluminium, silver / mirror  
Spiegelleuchte; Alu, silber / Spiegel  
applique pour miroir; aluminium, argent / miroir

L 500, H 700, A 30



2x 6,1W



1300lm



IP44



9 002759 997724



L 500

H 700

### 99773 BUENAVISTA

mirror light; aluminium, silver / mirror  
Spiegelleuchte; Alu, silber / Spiegel  
applique pour miroir; aluminium, argent / miroir

L 800, H 600, A 30



2x 5,1W



1100lm



IP44



9 002759 997731



L 800

H 600



99773



IP44



99838



IP44



99839



IP44

### 99838 BUENAVISTA 1

mirror light; aluminium, silver / mirror  
Spiegelleuchte; Alu, silber / Spiegel  
applique pour miroir; aluminium, argent / miroir

L 500, H 700, A 30



15,7W



1700lm



IP44



9 002759 998387



L 500

H 700

### 99839 BUENAVISTA 1

mirror light; aluminium, silver / mirror  
Spiegelleuchte; Alu, silber / Spiegel  
applique pour miroir; aluminium, argent / miroir

L 800, H 600, A 30



18,6W



2030lm



IP44



9 002759 998394

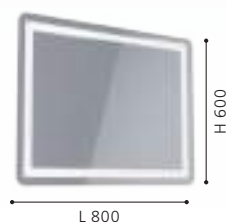

L 800

H 600

### 99853 BUENAVISTA 2

mirror light; aluminium, silver / mirror  
Spiegelleuchte; Alu, silber / Spiegel  
applique pour miroir; aluminium, argent / miroir

L 500, H 700, A 30



4x 7,1W



3000lm



IP44



9 002759 998530



L 500

H 700



99853



IP44



99854



IP44

## 99854 BUENAVISTA 2

mirror light; aluminium, silver / mirror

Spiegelleuchte; Alu, silber / Spiegel

applique pour miroir; aluminium, argent / miroir

L 800, H 600, A 30



4x 6,2 W



2600 lm



IP44



9 002759 998547

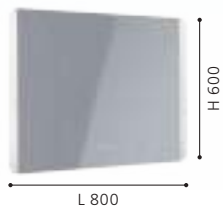

L 800

H 600

## BUENAVISTA 2

The additional anti-fog function prevents the mirrors from fogging up and ensures a clear view after showering.

Die zusätzliche Anti-Fog-Funktion verhindert das Beschlagen der Spiegel und sorgt für eine klare Sicht nach dem Duschen.

La fonction anti-buée supplémentaire empêche la formation de buée sur les miroirs et garantit une vision claire après la douche.



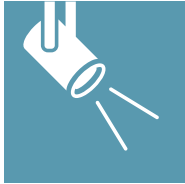

# SPOT & TRACK LUMINAIRES

SPOT- & SCHIENENLEUCHTEN  
SPOT & LUMINAIRES SUR RAIL



**EN SYSTEMATIC LIGHTING**

Our spot & track luminaires set specific highlights while optimally lighting your living rooms. No matter whether you prefer a modern or a traditional look – our range will fit any taste.

**DE BELEUCHTUNG MIT SYSTEM**

Mit unseren Spot- & Schienenleuchten setzen Sie gezielt Lichtakzente und sorgen zugleich für eine optimale Ausleuchtung Ihrer Wohnräume. Egal ob modern oder traditionell - unser Sortiment trifft jeden Geschmack.

**FR UN ÉCLAIRAGE AVEC SYSTÈME**

Nos spots et nos luminaires sur rail vous permettent d'offrir des accents ponctuels de lumière et assurent parallèlement un éclairage optimal de vos pièces d'habitat. Qu'ils soient modernes ou traditionnels - notre gamme répond à tous les goûts.







# OVERVIEW

SPOT & TRACK LUMINAIRES  
SPOT- & SCHIENENLEUCHTEN  
SPOT & LUMINAIRES

							
TOWNSHEND 3 682-685	BATALLAS 686-687	COTORRO 689	ESTEPERRA 690	VALBIANO 691	POLLICA 692	BERREGAS 694	CONSACA 696
							
CASIBARE 698	COSWARTH 700	ARRECIFE 703	CAROVIGNO 704	SAMBATELLO 706-709	COLSLADA 710	GIRONA 713	TABILLANO 714
							
ZAPATA 1 716	ZAPATA 719	SERAS 1 720-721	SERAS 722-723, 726-727	SERAS 2 724-725	DAKAR 1 728-729	ENEA 730-731	CORATO 733
							
BARNHAM 734-735	NOCITO 736-737	BIMEDA 738-741	LOCANDA 739	CAYUCA 743	SOREGO 744	VERGIANO 745	DAVIDA 746-747
							
DAVIDA 1 748-749	SARRIA 750-753	ZERACO 753	ROTTELO 754-755	BUZZ-LED 756-761	MAGNUM-LED 762-763	CABO 1 764	VILANOVA 764-765
							
CARDILLIO 1 766-767, 769	CARDILLIO 2 768-769	SALTO 770-771					



This product is available in different colors and shapes. / Dieser Artikel ist in unterschiedlichen Farben und Formen verfügbar. / Cet article est disponible en différentes couleurs et formes.





### 33169 TOWNSHEND 3

spot; wood, steel, brown, white  
 Spot; Holz, Stahl, braun, weiss  
 spot; bois, acier, marron, blanc

L 300, B 50



E27

2x 60W

### 33171 TOWNSHEND 3

spot; wood, steel, brown, white  
 Spot; Holz, Stahl, braun, weiss  
 spot; bois, acier, marron, blanc

L 480, B 50



E27

3x 60W

### 33172 TOWNSHEND 3

spot; wood, steel, brown, white  
 Spot; Holz, Stahl, braun, weiss  
 spot; bois, acier, marron, blanc

L 630, B 50



E27

4x 60W



9 002759 331696



L 300



9 002759 331719



L 480



9 002759 331726



L 630



33172



33168

### 33168 TOWNSHEND 3

spot; wood, steel, brown, white  
 Spot; Holz, Stahl, braun, weiss  
 spot; bois, acier, marron, blanc

L 165, B 50



E27



1x 10W



9 002759 331689

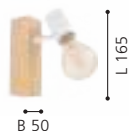



### 98112 TOWNSHEND 3

spot; wood, steel, brown, black  
 Spot; Holz, Stahl, braun, schwarz  
 spot; bois, acier, marron, noir

L 300, B 50



E27



2x 60W

### 98113 TOWNSHEND 3

spot; wood, steel, brown, black  
 Spot; Holz, Stahl, braun, schwarz  
 spot; bois, acier, marron, noir

L 480, B 50



E27



3x 60W

### 98114 TOWNSHEND 3

spot; wood, steel, brown, black  
 Spot; Holz, Stahl, braun, schwarz  
 spot; bois, acier, marron, noir

L 630, B 50



E27



4x 60W



9 002759 981129

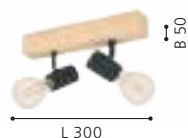

9 002759 981136



9 002759 981143





98114



98111

### 98111 TOWNSHEND 3

spot; wood, steel, brown, black  
 Spot; Holz, Stahl, braun, schwarz  
 spot; bois, acier, marron, noir

L 165, B 50



E27



1x 10W



9 002759 981112

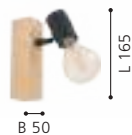



99488



99489



99491



### 99488 BATALLAS

spot; wood, steel, brown, black / fabric, black, white  
 Spot; Holz, Stahl, braun, schwarz / Textil, schwarz, weiss  
 spot; bois, acier, marron, noir / tissu, noir, blanc

L 100, H 170, A 205



E27



1x 10W

### 99489 BATALLAS

spot; wood, steel, brown, black / fabric, black, white  
 Spot; Holz, Stahl, braun, schwarz / Textil, schwarz, weiss  
 spot; bois, acier, marron, noir / tissu, noir, blanc

L 300, B 50



E27



2x 10W

### 99491 BATALLAS

spot; wood, steel, brown, black / fabric, black, white  
 Spot; Holz, Stahl, braun, schwarz / Textil, schwarz, weiss  
 spot; bois, acier, marron, noir / tissu, noir, blanc

L 480, B 50



E27



3x 10W



9 002759 994884



9 002759 994891



9 002759 994914







99492



### 99492 BATALLAS

spot; wood, steel, brown, black / fabric, black, white  
 Spot; Holz, Stahl, braun, schwarz / Textil, schwarz, weiss  
 spot; bois, acier, marron, noir / tissu, noir, blanc

L 630, B 50



E27



4x 10W



9 002759 994921





900433





900432



COTORRO



900434



### 900433 COTORRO

spot; wood, steel, brown, black  
Spot; Holz, Stahl, braun, schwarz  
spot; bois, acier, marron, noir

L 840, B 145, H 230



E27 3x 25W

### 900432 COTORRO

spot; wood, steel, brown, black  
Spot; Holz, Stahl, braun, schwarz  
spot; bois, acier, marron, noir

L 540, B 145, H 230



E27 2x 25W

### 900434 COTORRO

spot; wood, steel, brown, black  
Spot; Holz, Stahl, braun, schwarz  
spot; bois, acier, marron, noir

L 145, H 220, A 230



E27 1x 25W



9 008606 243891



9 008606 243884



9 008606 243907





### 99276 ESTEPERRA

spot; steel, black / fabric, black, gold  
 Spot; Stahl, schwarz / Textil, schwarz, gold  
 spot; acier, noir / tissu, noir, or

H 240, Ø 120



E27

1x 28W

### 99277 ESTEPERRA

spot; steel, black / fabric, black, gold  
 Spot; Stahl, schwarz / Textil, schwarz, gold  
 spot; acier, noir / tissu, noir, or

L 335, B 90



E27

2x 28W

### 99278 ESTEPERRA

spot; steel, black / fabric, black, gold  
 Spot; Stahl, schwarz / Textil, schwarz, gold  
 spot; acier, noir / tissu, noir, or

L 575, B 90



E27

3x 28W



9 002759 992767



Ø 120



9 002759 992774



L 335



9 002759 992781



L 575



**97536**

**97537**



**97538**

**97536 VALBIANO**

spot; steel, brushed brass, satin nickel / fabric, cappuccino, gold  
 Spot; Stahl, messing-gebürstet, nickel-matt / Textil, cappuccino, gold  
 spot; acier, laiton brossé, nickel mat / tissu, cappucino, or

L 110, B 110



E14 1x 7W

**97537 VALBIANO**

spot; steel, brushed brass, satin nickel / fabric, cappuccino, gold  
 Spot; Stahl, messing-gebürstet, nickel-matt / Textil, cappuccino, gold  
 spot; acier, laiton brossé, nickel mat / tissu, cappucino, or

L 320, B 70



E14 2x 7W

**97538 VALBIANO**

spot; steel, brushed brass, satin nickel / fabric, cappuccino, gold  
 Spot; Stahl, messing-gebürstet, nickel-matt / Textil, cappuccino, gold  
 spot; acier, laiton brossé, nickel mat / tissu, cappucino, or

L 560, B 70



E14 3x 7W



9 002759 975364



L 110



9 002759 975371

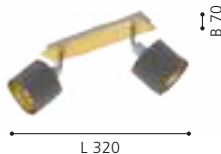

L 320



9 002759 975388



L 560



**98624**



**98625**

### 98624 POLLICA

spot; steel, black / glass vaporized, black-transparent  
 Spot; Stahl, schwarz / Glas bedampft, schwarz-transparent  
 spot; acier, noir / verre vaporisé, noir transparent

L 65, H 105



E14

1x 10W

### 98625 POLLICA

spot; steel, black / glass vaporized, black-transparent  
 Spot; Stahl, schwarz / Glas bedampft, schwarz-transparent  
 spot; acier, noir / verre vaporisé, noir transparent

L 365, B 165



E14

2x 28W

### 98626 POLLICA

spot; steel, black / glass vaporized, black-transparent  
 Spot; Stahl, schwarz / Glas bedampft, schwarz-transparent  
 spot; acier, noir / verre vaporisé, noir transparent

L 640, B 220



E14

4x 28W



9 002759 986247



9 002759 986254



9 002759 986261





98626





**99052**



**99053**

### 99052 BERREGAS

spot; steel, black, chrome / glass vaporized, black-transparent  
 Spot; Stahl, schwarz, chrom / Glas bedampft, schwarz-transparent  
 spot; acier, noir, chrome / verre vaporisé, noir transparent

Ø 110



E27

1x 28W

### 99053 BERREGAS

spot; steel, black, chrome / glass vaporized, black-transparent  
 Spot; Stahl, schwarz, chrom / Glas bedampft, schwarz-transparent  
 spot; acier, noir, chrome / verre vaporisé, noir transparent

L 440, B 110



E27

2x 40W

### 99054 BERREGAS

spot; steel, black, chrome / glass vaporized, black-transparent  
 Spot; Stahl, schwarz, chrom / Glas bedampft, schwarz-transparent  
 spot; acier, noir, chrome / verre vaporisé, noir transparent

L 775, B 110



E27

3x 40W







99054



99711



CONSACA



99713

### 99711 CONSACA

spot; steel, black / glass vaporized, black-transparent  
Spot; Stahl, schwarz / Glas bedampft, schwarz-transparent  
spot; acier, noir / verre vaporisé, noir transparent

L 120, H 220, A 235



E27

1x 28W

### 99713 CONSACA

spot; steel, black / glass vaporized, black-transparent  
Spot; Stahl, schwarz / Glas bedampft, schwarz-transparent  
spot; acier, noir / verre vaporisé, noir transparent

L 780, H 205, A 235



E27

4x 40W

### 99712 CONSACA

spot; steel, black / glass vaporized, black-transparent  
Spot; Stahl, schwarz / Glas bedampft, schwarz-transparent  
spot; acier, noir / verre vaporisé, noir transparent

L 340, H 205, A 235



E27

2x 40W



9 002759 997113



9 002759 997137



9 002759 997120





99712



**99517**



**99518**

**99517 CASIBARE**

spot; steel, black  
Spot; Stahl, schwarz  
spot; acier, noir

L 120, H 185, A 190



E27



1x 28W

**99518 CASIBARE**

spot; steel, black  
Spot; Stahl, schwarz  
spot; acier, noir

L 335, H 175, A 180



E27



2x 28W

**99519 CASIBARE**

spot; steel, black  
Spot; Stahl, schwarz  
spot; acier, noir

L 575, H 175, A 180



E27



3x 28W



9 002759 995171



9 002759 995188



9 002759 995195





99519





**99075**



**99076**

### 99075 COSWARTH

spot; steel, wood, anthracite, cream-white, brown  
Spot; Stahl, Holz, anthrazit, creme-weiss, braun  
spot; acier, bois, gris anthracite, blanc crème,

L 480, B 140, H 240



E27



2x 40W

### 99076 COSWARTH

spot; steel, wood, anthracite, cream-white, brown  
Spot; Stahl, Holz, anthrazit, creme-weiss, braun  
spot; acier, bois, gris anthracite, blanc crème,

L 670, B 140, H 240



E27



3x 40W

### 99074 COSWARTH

spot; steel, wood, anthracite, cream-white, brown  
Spot; Stahl, Holz, anthrazit, creme-weiss, braun  
spot; acier, bois, gris anthracite, blanc crème,

L 140, H 200



E27



1x 25W



9 002759 990756



L 480

H 240



9 002759 990763



L 670

H 240



9 002759 990749



L 140

H 200



99074





900713





900712



900711

### 900713 ARRECIFE

spot; steel, brown, satin nickel / steel, sandy  
 Spot; Stahl, braun, nickel-matt / Stahl, sandfarben  
 spot; acier, marron, nickel mat / acier, couleur sable

L 745, B 145, H 235



E27 3x 28W



9 008606 262045



### 900712 ARRECIFE

spot; steel, brown, satin nickel / steel, sandy  
 Spot; Stahl, braun, nickel-matt / Stahl, sandfarben  
 spot; acier, marron, nickel mat / acier, couleur sable

L 531, B 145, H 235



E27 2x 28W



9 008606 262038



### 900711 ARRECIFE

spot; steel, brown, satin nickel / steel, sandy  
 Spot; Stahl, braun, nickel-matt / Stahl, sandfarben  
 spot; acier, marron, nickel mat / acier, couleur sable

H 235, Ø 145



E27 1x 28W



9 008606 262021





98621



98623

### 98621 CAROVIGNO

spot; steel, black  
Spot; Stahl, schwarz  
spot; acier, noir

L 65, H 105



E14



1x 28W

### 98623 CAROVIGNO

spot; steel, black  
Spot; Stahl, schwarz  
spot; acier, noir

L 640, B 150



E14



4x 40W

### 98622 CAROVIGNO

spot; steel, black  
Spot; Stahl, schwarz  
spot; acier, noir

L 365, B 150



E14



2x 40W



9 002759 986216



9 002759 986230

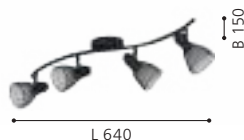

9 002759 986223





98622



**98134**



**98135**



**98137**

**98134 SAMBATELLO**

spot; wood, steel, brown, silver / steel, silver  
 Spot; Holz, Stahl, braun, silber / Stahl, silber  
 spot; bois, acier, marron, argent / acier, argent

L 150, H 220, A 240



E27 1x 40W

**98135 SAMBATELLO**

spot; wood, steel, brown, silver / steel, silver  
 Spot; Holz, Stahl, braun, silber / Stahl, silber  
 spot; bois, acier, marron, argent / acier, argent

L 335, B 90



E27 2x 40W

**98137 SAMBATELLO**

spot; wood, steel, brown, silver / steel, silver  
 Spot; Holz, Stahl, braun, silber / Stahl, silber  
 spot; bois, acier, marron, argent / acier, argent

L 795, B 90



E27 4x 40W



9 002759 981341

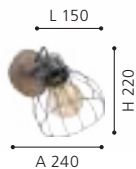

9 002759 981358

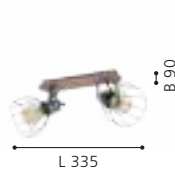

9 002759 981372





**98136**

**98136 SAMBATELLO**

spot; wood, steel, brown, silver / steel, silver  
Spot; Holz, Stahl, braun, silber / Stahl, silber  
spot; bois, acier, marron, argent / acier, argent

L 575, B 90



E27



3x 40W



9 002759 981365





900382





**900383**



**900384**

**900382 SAMBATELLO**

spot; steel, wood, black, brushed brass  
 Spot; Stahl, Holz, schwarz, messing-gebürstet  
 spot; acier, bois, noir, laiton brossé

L 260, B 150, H 220



E27 1x 40W

**900383 SAMBATELLO**

spot; steel, wood, black, brushed brass  
 Spot; Stahl, Holz, schwarz, messing-gebürstet  
 spot; acier, bois, noir, laiton brossé

L 480, B 280, H 260



E27 2x 40W

**900384 SAMBATELLO**

spot; steel, wood, black, brushed brass  
 Spot; Stahl, Holz, schwarz, messing-gebürstet  
 spot; acier, bois, noir, laiton brossé

L 700, B 280, H 260



E27 3x 40W



9 008606 243631



L 260

H 220



9 008606 243648

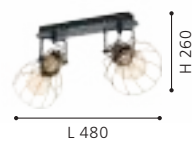

L 480

H 260



9 008606 243655



L 700

H 260



**900693**



**900694**



EGLO  
RECOMMENDS  
**110052**

COSLADA

### 900693 COSLADA

spot; steel, black / steel, black, brass  
Spot; Stahl, schwarz / Stahl, schwarz, messing  
spot; acier, noir / acier, noir, laiton

L 130, H 200, A 170



E27



1x 40W

### 900694 COSLADA

spot; steel, black / steel, black, brass  
Spot; Stahl, schwarz / Stahl, schwarz, messing  
spot; acier, noir / acier, noir, laiton

L 320, B 80, H 170



E27



2x 40W

### 900695 COSLADA

spot; steel, black / steel, black, brass  
Spot; Stahl, schwarz / Stahl, schwarz, messing  
spot; acier, noir / acier, noir, laiton

L 790, B 80, H 170



E27



4x 40W



9 008606 262052



9 008606 262069



9 008606 262076







900695





900662





GIRONA



900661



900663

### 900662 GIRONA

spot; steel, black, brushed brass  
Spot; Stahl, schwarz, messing-gebürstet  
spot; acier, noir, laiton brossé

L 440, B 190, H 150



E27 2x 40W

### 900661 GIRONA

spot; steel, black, brushed brass  
Spot; Stahl, schwarz, messing-gebürstet  
spot; acier, noir, laiton brossé

L 190, B 140, H 150



E27 1x 40W

### 900663 GIRONA

spot; steel, black, brushed brass  
Spot; Stahl, schwarz, messing-gebürstet  
spot; acier, noir, laiton brossé

L 775, B 190, H 150



E27 3x 40W



9 008606 258598



9 008606 258581



9 008606 258604





### 98763 TABILLANO

spot; steel, black  
Spot; Stahl, schwarz  
spot; acier, noir

L 440, B 110



E27

2x 40W

### 98764 TABILLANO

spot; steel, black  
Spot; Stahl, schwarz  
spot; acier, noir

L 775, B 110



E27

3x 40W

### 98762 TABILLANO

spot; steel, black  
Spot; Stahl, schwarz  
spot; acier, noir

Ø 110



E27

1x 40W



9 002759 987633

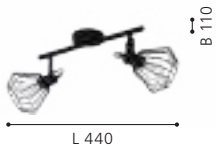

9 002759 987640



9 002759 987626





98762





32765

LED



32767

LED

### 32765 ZAPATA 1

spot; steel, black / glass, amber  
Spot; Stahl, schwarz / Glas, amber  
spot; acier, noir / verre, ambre

Ø 60



G9



1x 3W



1x  
warm  
WHITE  
320lm

### 32767 ZAPATA 1

spot; steel, black / glass, amber  
Spot; Stahl, schwarz / Glas, amber  
spot; acier, noir / verre, ambre

L 635, B 65



G9



4x 3W



4x  
warm  
WHITE  
320lm

### 32766 ZAPATA 1

spot; steel, black / glass, amber  
Spot; Stahl, schwarz / Glas, amber  
spot; acier, noir / verre, ambre

L 360, B 65



G9



2x 3W



2x  
warm  
WHITE  
320lm



9 002759 327651



9 002759 327675



L 635



9 002759 327668



L 360



32766

LED



95547

LED





95546

LED



95545

LED

DESIGN  
HIGHLIGHT  
DETAIL



### 95547 ZAPATA

spot; steel, copper / satin glass, white  
Spot; Stahl, kupfer / Glas satiniert, weiss  
spot; acier, cuivre / verre satiné, blanc

L 515, B 65

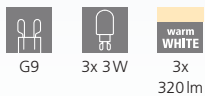

9 002759 955472



### 95546 ZAPATA

spot; steel, copper / satin glass, white  
Spot; Stahl, kupfer / Glas satiniert, weiss  
spot; acier, cuivre / verre satiné, blanc

L 360, B 65

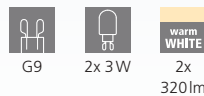

9 002759 955465



### 95545 ZAPATA

spot; steel, copper / satin glass, white  
Spot; Stahl, kupfer / Glas satiniert, weiss  
spot; acier, cuivre / verre satiné, blanc

Ø 60



9 002759 955458





98393

LED



98394

LED



98396

LED

### 98393 SERAS 1

spot; steel, white  
Spot; Stahl, weiss  
spot; acier, blanc

Ø 100



GU10



1x 3W



1x  
warm  
WHITE  
250lm

### 98394 SERAS 1

spot; steel, white  
Spot; Stahl, weiss  
spot; acier, blanc

L 370, B 65



GU10



2x 3W



2x  
warm  
WHITE  
250lm

### 98396 SERAS 1

spot; steel, white  
Spot; Stahl, weiss  
spot; acier, blanc

L 770, B 65



GU10



4x 3W



4x  
warm  
WHITE  
250lm



9 002759 983932



Ø 100



9 002759 983949



L 370



9 002759 983963



L 770



98395

LED

### 98395 SERAS 1

spot; steel, white  
Spot; Stahl, weiss  
spot; acier, blanc

L 595, B 65



GU10



3x 3W



warm  
WHITE  
3x  
250lm



9 002759 983956



INCL.

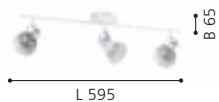



96552

LED



DESIGN  
HIGHLIGHT  
DETAIL

### 96552 SERAS

spot; steel, antique nickel, cream  
Spot; Stahl, nickel-antik, creme  
spot; acier, nickel antique, crème

Ø 100



GU10



1x 3W



1x  
warm  
WHITE  
250lm



9 002759 965525



INCL.

Ø 100





96553



96554



96555



### 96553 SERAS

spot; steel, antique nickel, cream  
Spot; Stahl, nickel-antik, creme  
spot; acier, nickel antique, crème

L 370, B 65



GU10



2x 3W



warm  
WHITE

2x  
250lm

### 96554 SERAS

spot; steel, antique nickel, cream  
Spot; Stahl, nickel-antik, creme  
spot; acier, nickel antique, crème

L 595, B 65



GU10



3x 3W



warm  
WHITE

3x  
250lm

### 96555 SERAS

spot; steel, antique nickel, cream  
Spot; Stahl, nickel-antik, creme  
spot; acier, nickel antique, crème

L 770, B 65



GU10



4x 3W



warm  
WHITE

4x  
250lm



9 002759 965532



L 370



9 002759 965549



L 595



9 002759 965556



L 770



98398

LED



98397

LED

### 98398 SERAS 2

spot; steel, black  
Spot; Stahl, schwarz  
spot; acier, noir

L 370, B 65



GU10



2x 3W



warm  
WHITE  
2x  
250lm



9 002759 983987



INCL.





98399

LED



98408

LED

### 98397 SERAS 2

spot; steel, black  
Spot; Stahl, schwarz  
spot; acier, noir

Ø 100



GU10



1x 3W



1x  
warm  
WHITE  
250lm

### 98399 SERAS 2

spot; steel, black  
Spot; Stahl, schwarz  
spot; acier, noir

L 595, B 65



GU10



3x 3W



3x  
warm  
WHITE  
250lm

### 98408 SERAS 2

spot; steel, black  
Spot; Stahl, schwarz  
spot; acier, noir

L 770, B 65



GU10



4x 3W



4x  
warm  
WHITE  
250lm



9 002759 983970



Ø 100



9 002759 983994



L 595

B 65



9 002759 984083



L 770

B 65



900169

LED



900171

LED



900173

LED

**900169 SERAS**

spot; steel, brushed brass, gold  
Spot; Stahl, messing-gebürstet, gold  
spot; acier, laiton brossé, or

Ø 100



GU10



1x 3W



warm WHITE

1x

250lm

**900171 SERAS**

spot; steel, brushed brass, gold  
Spot; Stahl, messing-gebürstet, gold  
spot; acier, laiton brossé, or

L 370, B 65



GU10



2x 3W



warm WHITE

2x

250lm

**900173 SERAS**

spot; steel, brushed brass, gold  
Spot; Stahl, messing-gebürstet, gold  
spot; acier, laiton brossé, or

L 770, B 65



GU10



4x 3W



warm WHITE

4x

250lm



9 008606 235643



9 008606 235650



9 008606 235674







900172

LED

### 900172 SERAS

spot; steel, brushed brass, gold  
Spot; Stahl, messing-gebürstet, gold  
spot; acier, laiton brossé, or

L 595, B 65



GU10



3x 3W



warm  
WHITE  
3x  
250lm



9 008606 235667





**88472**



DESIGN  
HIGHLIGHT  
DETAIL



**88473**

**88472 DAKAR 1**

spot; steel, satin nickel / glass wiping technique, white  
Spot; Stahl, nickel-matt / Glas Wischtechnik, weiss  
spot; acier, nickel mat / technique de verre essuyé, blanc

L 105, B 65



E14



1x 25W

**88473 DAKAR 1**

spot; steel, satin nickel / glass wiping technique, white  
Spot; Stahl, nickel-matt / Glas Wischtechnik, weiss  
spot; acier, nickel mat / technique de verre essuyé, blanc

L 370, B 100



E14



2x 40W



9 002759 884727



L 105



9 002759 884734



L 370

B 100



88474



88475

### 88474 DAKAR 1

spot; steel, satin nickel / glass wiping technique, white  
 Spot; Stahl, nickel-matt / Glas Wischtechnik, weiss  
 spot; acier, nickel mat / technique de verre essuyé, blanc

L 650, B 100



E14 4x 40W



9 002759 88474 1

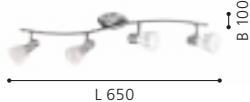

### 88475 DAKAR 1

spot; steel, satin nickel / glass wiping technique, white  
 Spot; Stahl, nickel-matt / Glas Wischtechnik, weiss  
 spot; acier, nickel mat / technique de verre essuyé, blanc

Ø 295



E14 3x 40W



9 002759 88475 8





### 90984 ENEA

spot; steel, satin nickel / satin glass, white  
 Spot; Stahl, nickel-matt / Glas satiniert, weiss  
 spot; acier, nickel mat / verre satiné, blanc

L 300, B 70



E14 2x 40W

### 90986 ENEA

spot; steel, satin nickel / satin glass, white  
 Spot; Stahl, nickel-matt / Glas satiniert, weiss  
 spot; acier, nickel mat / verre satiné, blanc

Ø 265



E14 3x 40W

### 90985 ENEA

spot; steel, satin nickel / satin glass, white  
 Spot; Stahl, nickel-matt / Glas satiniert, weiss  
 spot; acier, nickel mat / verre satiné, blanc

L 500, B 70



E14 3x 40W



9 002759 909840



9 002759 909864



9 002759 909857

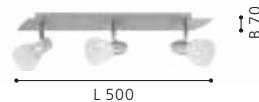



90982

### 90982 ENEA

spot; steel, satin nickel / satin glass, white  
Spot; Stahl, nickel-matt / Glas satiniert, weiss  
spot; acier, nickel mat / verre satiné, blanc

L 190, B 70



E14



1x 25W



9 002759 909826

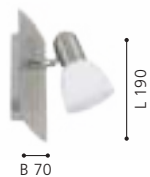



900715



900714



900716

### 900715 CORATO

spot; steel, sandy, satin nickel / glass, white  
 Spot; Stahl, sandfarben, nickel-matt / Glas, weiss  
 spot; acier, couleur sable, nickel mat / verre, blanc

L 300, H 125, A 150

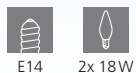

E14 2x 18W

### 900714 CORATO

spot; steel, sandy, satin nickel / glass, white  
 Spot; Stahl, sandfarben, nickel-matt / Glas, weiss  
 spot; acier, couleur sable, nickel mat / verre, blanc

L 85, H 125, A 150

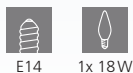

E14 1x 18W

### 900716 CORATO

spot; steel, sandy, satin nickel / glass, white  
 Spot; Stahl, sandfarben, nickel-matt / Glas, weiss  
 spot; acier, couleur sable, nickel mat / verre, blanc

L 520, H 125, A 150

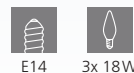

E14 3x 18W



9 008606 262120



L 300

H 125



9 008606 262113

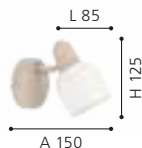

L 85

A 150

H 125



9 008606 262137



L 520

H 125



94585

LED



94586

LED

**94585 BARNHAM**

spot; steel, black, copper  
Spot; Stahl, schwarz, kupfer  
spot; acier, noir, cuivre

L 395, B 70



GU10



2x 3W



warm  
WHITE  
2x  
250lm



9 002759 945855



L 395

**94586 BARNHAM**

spot; steel, black, copper  
Spot; Stahl, schwarz, kupfer  
spot; acier, noir, cuivre

L 585, B 70



GU10



3x 3W



warm  
WHITE  
3x  
250lm



9 002759 945862



L 585

**94587 BARNHAM**

spot; steel, black, copper  
Spot; Stahl, schwarz, kupfer  
spot; acier, noir, cuivre

L 780, B 70



GU10



4x 3W



warm  
WHITE  
4x  
250lm



9 002759 945879



L 780





94587

LED



94584

LED

### 94584 BARNHAM

spot; steel, black, copper  
 Spot; Stahl, schwarz, kupfer  
 spot; acier, noir, cuivre

L 165, B 70



GU10



1x 3W



warm  
 WHITE  
 1x  
 250lm



9 002759 945848



INCL.

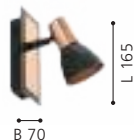



95482

LED



95483

LED



95485

LED

### 95482 NOCITO

spot; steel, black, gold  
Spot; Stahl, schwarz, gold  
spot; acier, noir, or

Ø 110



GU10



1x 3W



1x  
warm  
WHITE  
250lm

### 95483 NOCITO

spot; steel, black, gold  
Spot; Stahl, schwarz, gold  
spot; acier, noir, or

L 360, B 105



GU10



2x 3W



2x  
warm  
WHITE  
250lm

### 95485 NOCITO

spot; steel, black, gold  
Spot; Stahl, schwarz, gold  
spot; acier, noir, or

L 760, B 105



GU10



4x 3W



4x  
warm  
WHITE  
250lm



9 002759 954826



Ø 110



9 002759 954833



L 360

B 105



9 002759 954857



L 760

B 105



95484

LED

### 95484 NOCITO

spot; steel, black, gold  
Spot; Stahl, schwarz, gold  
spot; acier, noir, or

L 585, B 105



GU10



3x 3W



warm  
WHITE  
3x  
250lm



9 002759 954840



INCL.



DESIGN  
HIGHLIGHT  
DETAIL



31001

LED



31002

LED



31004

LED

### 31001 BIMEDA

spot; steel, white, chrome  
Spot; Stahl, weiss, chrom  
spot; acier, blanc, chrome

Ø 70



GU10



1x 2,8W



1x  
250lm

### 31002 BIMEDA

spot; steel, white, chrome  
Spot; Stahl, weiss, chrom  
spot; acier, blanc, chrome

L 365, B 100



GU10



2x 2,8W



2x  
250lm

### 31004 BIMEDA

spot; steel, white, chrome  
Spot; Stahl, weiss, chrom  
spot; acier, blanc, chrome

L 640, B 100



GU10



4x 2,8W



4x  
250lm



9 002759 310011



Ø 70



9 002759 310028



B 100

L 365



9 002759 310042



B 100

L 640



31003

LED



94252

LED

### 31003 BIMEDA

spot; steel, white, chrome  
Spot; Stahl, weiss, chrom  
spot; acier, blanc, chrome

L 290, H 345



GU10



3x 2,8W



3x  
warm  
WHITE  
250lm



9 002759 310035



L 290

H 345

### 94252 LOCANDA

ceiling light; steel, white, chrome  
Deckenleuchte; Stahl, weiss, chrom  
plafonnier; acier, blanc, chrome

L 700, B 660



GU10



5x 2,8W



5x  
warm  
WHITE  
250lm



9 002759 942526

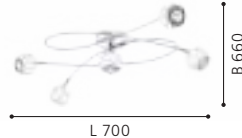

L 700

B 660





31005

LED



DESIGN  
HIGHLIGHT  
DETAIL

### 31005 BIMEDA

spot; steel, nickel-nero, chrome  
Spot; Stahl, nickel-nero, chrom  
spot; acier, nickel brillant, chrome

Ø 70



GU10



1x 2,8W



1x

250lm



9 002759 310059





31006

LED



31007

LED



31008

LED

### 31006 BIMEDA

spot; steel, nickel-nero, chrome  
Spot; Stahl, nickel-nero, chrom  
spot; acier, nickel brillant, chrome

L 365, B 100

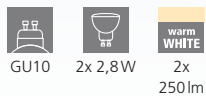

### 31007 BIMEDA

spot; steel, nickel-nero, chrome  
Spot; Stahl, nickel-nero, chrom  
spot; acier, nickel brillant, chrome

L 290, H 345



### 31008 BIMEDA

spot; steel, nickel-nero, chrome  
Spot; Stahl, nickel-nero, chrom  
spot; acier, nickel brillant, chrome

L 640, B 100

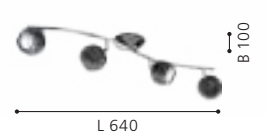
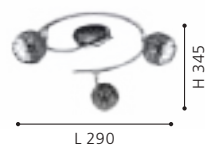
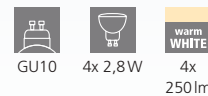



900438

LED





900436

LED



900437

LED

### 900438 CAYUCA

spot; steel, black / wood, brown  
Spot; Stahl, schwarz / Holz, braun  
spot; acier, noir / bois, marron

L 580, B 100, H 120



GU10



4x 3W



warm  
WHITE  
4x  
250lm



9 008606 240005



L 580

H 120

### 900436 CAYUCA

spot; steel, black / wood, brown  
Spot; Stahl, schwarz / Holz, braun  
spot; acier, noir / bois, marron

L 110, B 105, H 120



GU10



1x 3W



warm  
WHITE  
1x  
250lm



9 008606 239986



L 110

H 120

### 900437 CAYUCA

spot; steel, black / wood, brown  
Spot; Stahl, schwarz / Holz, braun  
spot; acier, noir / bois, marron

L 280, B 100, H 120



GU10



2x 3W



warm  
WHITE  
2x  
250lm



9 008606 239993



L 280

H 120



900331



900332



900333



### 900331 SOREGO

spot; steel, black  
Spot; Stahl, schwarz  
spot; acier, noir

L 110, B 105, H 120



GU10



1x 3W



warm  
WHITE  
1x  
250lm

### 900332 SOREGO

spot; steel, black  
Spot; Stahl, schwarz  
spot; acier, noir

L 280, B 100, H 120



GU10



2x 3W



warm  
WHITE  
2x  
250lm

### 900333 SOREGO

spot; steel, black  
Spot; Stahl, schwarz  
spot; acier, noir

L 580, B 100, H 120



GU10



4x 3W



warm  
WHITE  
4x  
250lm



9 008606 239078



L 110



9 008606 239085



L 280



9 008606 239092



L 580



97506

LED



97507

LED



97508

LED

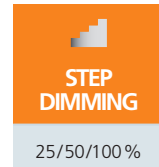

97506

97507

97508

### 97506 VERGIANO

spot; aluminium, steel, white, satin nickel  
Spot; Alu, Stahl, weiss, nickel-matt  
spot; aluminium, acier, blanc, nickel mat

L 70, H 165

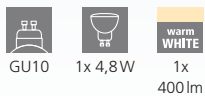

GU10 1x 4,8W 1x warm WHITE 400lm



9 002759 975067



### 97507 VERGIANO

spot; aluminium, steel, white, satin nickel  
Spot; Alu, Stahl, weiss, nickel-matt  
spot; aluminium, acier, blanc, nickel mat

L 390, B 70

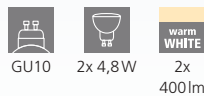

GU10 2x 4,8W 2x warm WHITE 400lm



9 002759 975074



### 97508 VERGIANO

spot; aluminium, steel, white, satin nickel  
Spot; Alu, Stahl, weiss, nickel-matt  
spot; aluminium, acier, blanc, nickel mat

L 690, B 70

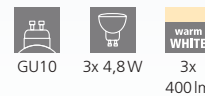

GU10 3x 4,8W 3x warm WHITE 400lm



9 002759 975081

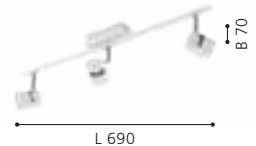



92084

LED



92085

LED



92086

LED

### 92084 DAVIDA

spot; steel, chrome, white  
Spot; Stahl, chrom, weiss  
spot; acier, chrome, blanc

L 165, B 70



GU10



1x 4,6W



warm  
WHITE

1x

400lm



### 92085 DAVIDA

spot; steel, chrome, white  
Spot; Stahl, chrom, weiss  
spot; acier, chrome, blanc

L 390, B 70



GU10



2x 4,6W



warm  
WHITE

2x

400lm

### 92086 DAVIDA

spot; steel, chrome, white  
Spot; Stahl, chrom, weiss  
spot; acier, chrome, blanc

L 580, B 70



GU10



3x 4,6W



warm  
WHITE

3x

400lm



9 002759 920845



B 70



9 002759 920852



L 390



9 002759 920869



L 580



92087

LED

### 92087 DAVIDA

spot; steel, chrome, white  
Spot; Stahl, chrom, weiss  
spot; acier, chrome, blanc

L 780, B 70



GU10



4x 4,6 W



4x  
warm  
WHITE  
400 lm



9 002759 920876

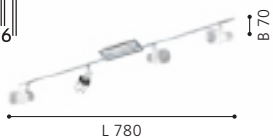

DESIGN  
HIGHLIGHT  
DETAIL





30833

LED



30832

LED

### 30832 DAVIDA 1

spot; steel, nickel-nero  
Spot; Stahl, nickel-nero  
spot; acier, nickel noir

L 165, B 70



GU10



1x 4,6W



warm  
WHITE

1x

400lm



9 002759 308322



INCL.

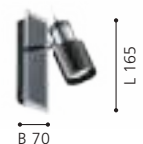



30834

LED



30835

LED

**30833 DAVIDA 1**

spot; steel, nickel-nero  
Spot; Stahl, nickel-nero  
spot; acier, nickel noir

L 390, B 70

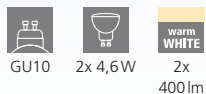

**30834 DAVIDA 1**

spot; steel, nickel-nero  
Spot; Stahl, nickel-nero  
spot; acier, nickel noir

L 580, B 70

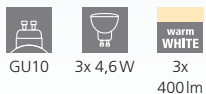

**30835 DAVIDA 1**

spot; steel, nickel-nero  
Spot; Stahl, nickel-nero  
spot; acier, nickel noir

L 780, B 70

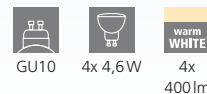

9 002759 308339



L 390



9 002759 308346



L 580



9 002759 308353



L 780



94962

LED



94958

LED

### 94962 SARRIA

spot; steel, white, chrome  
Spot; Stahl, weiss, chrom  
spot; acier, blanc, chrome

L 240, H 260



GU10



4x 4,5W



warm  
WHITE

4x

345lm



9 002759 949624



INCL.



L 240

H 260





94959

LED







94961

LED

**94958 SARRIA**

spot; steel, white, chrome  
Spot; Stahl, weiss, chrom  
spot; acier, blanc, chrome

L 120, B 60



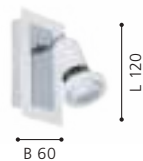



  
 GU10 1x 4,5W 1x 345lm



**94959 SARRIA**

spot; steel, white, chrome  
Spot; Stahl, weiss, chrom  
spot; acier, blanc, chrome

L 300, B 70



  
 GU10 2x 4,5W 2x 345lm



**94961 SARRIA**

spot; steel, white, chrome  
Spot; Stahl, weiss, chrom  
spot; acier, blanc, chrome

L 460, B 70

  
 GU10 3x 4,5W 3x 345lm





94963



94966



94964



### 94963 SARRIA

spot; steel, black, chrome  
Spot; Stahl, schwarz, chrom  
spot; acier, noir, chrome

L 120, B 60

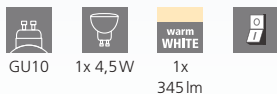

### 94964 SARRIA

spot; steel, black, chrome  
Spot; Stahl, schwarz, chrom  
spot; acier, noir, chrome

L 300, B 70

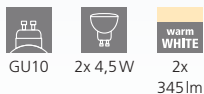

### 94966 SARRIA

spot; steel, black, chrome  
Spot; Stahl, schwarz, chrom  
spot; acier, noir, chrome

L 240, H 260

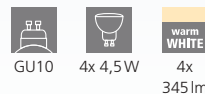



94965

LED



93679

LED

**94965 SARRIA**

spot; steel, black, chrome  
Spot; Stahl, schwarz, chrom  
spot; acier, noir, chrome

L 460, B 70

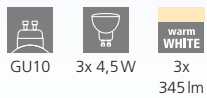

**93679 ZERACO**

spot; steel, plastic, satin nickel  
Spot; Stahl, Kunststoff, nickel-matt  
spot; acier, plastique, nickel mat

L 940, B 120

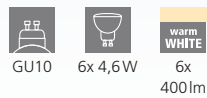

9 002759 949655



L 460



9 002759 936792



L 940



90915

LED



90914

LED



90916

LED

**90915 ROTTELO**

spot; steel, satin nickel, chrome  
Spot; Stahl, nickel-matt, chrom  
spot; acier, nickel mat, chrome

L 280, B 70



GU10



2x 4,6W



warm WHITE

2x 400lm



9 002759 909154



L 280

B 70

**90914 ROTTELO**

spot; steel, satin nickel, chrome  
Spot; Stahl, nickel-matt, chrom  
spot; acier, nickel mat, chrome

L 120, B 60



GU10



1x 4,6W



warm WHITE

1x 400lm



9 002759 909147



B 60

L 120



9 002759 909161



L 260

B 240



90917



90927



### 90917 ROTTELO

spot; steel, satin nickel, chrome  
 Spot; Stahl, nickel-matt, chrom  
 spot; acier, nickel mat, chrome

L 780, B 70

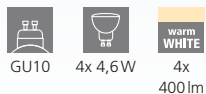

### 90927 ROTTELO

spot; steel, satin nickel, chrome  
 Spot; Stahl, nickel-matt, chrom  
 spot; acier, nickel mat, chrome

L 1160, B 70

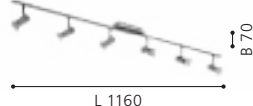
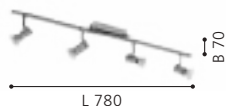
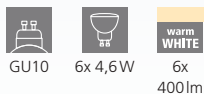



92595

LED



92596

LED



92597

LED

### 92595 BUZZ-LED

spot; steel, satin nickel  
Spot; Stahl, nickel-matt  
spot; acier, nickel mat

Ø 60



GU10



1x 2,8W



1x  
250lm

### 92596 BUZZ-LED

spot; steel, satin nickel  
Spot; Stahl, nickel-matt  
spot; acier, nickel mat

L 285, B 65



GU10



2x 2,8W



2x  
250lm

### 92597 BUZZ-LED

spot; steel, satin nickel  
Spot; Stahl, nickel-matt  
spot; acier, nickel mat

L 485, B 65



GU10



3x 2,8W



3x  
250lm



9 002759 925956



Ø 60



9 002759 925963



L 285

B 65



9 002759 925970



L 485

B 65



92598

LED



92599

LED

### 92598 BUZZ-LED

spot; steel, satin nickel  
Spot; Stahl, nickel-matt  
spot; acier, nickel mat

L 685, B 65



GU10



4x 2,8W



4x  
warm  
WHITE  
250lm



9 002759 925987

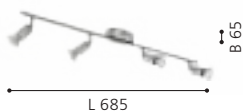

### 92599 BUZZ-LED

spot; steel, satin nickel  
Spot; Stahl, nickel-matt  
spot; acier, nickel mat

L 1050, B 65



GU10



6x 2,8W



6x  
warm  
WHITE  
250lm



9 002759 925994

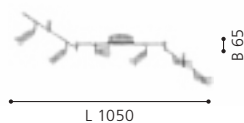



32428

LED



32429

LED



32431

LED

### 32428 BUZZ-LED

spot; steel, black  
Spot; Stahl, schwarz  
spot; acier, noir

Ø 60



GU10



1x 2,8W



1x  
warm  
WHITE  
250lm

### 32429 BUZZ-LED

spot; steel, black  
Spot; Stahl, schwarz  
spot; acier, noir

L 285, B 65



GU10



2x 2,8W



2x  
warm  
WHITE  
250lm

### 32431 BUZZ-LED

spot; steel, black  
Spot; Stahl, schwarz  
spot; acier, noir

L 485, B 65



GU10



3x 2,8W



3x  
warm  
WHITE  
250lm



9 002759 324285



Ø 60



9 002759 324292



L 285

B 65



9 002759 324315



L 485

B 65





32432

LED



32433

LED

### 32432 BUZZ-LED

spot; steel, black  
Spot; Stahl, schwarz  
spot; acier, noir

L 685, B 65



GU10



4x 2,8W



4x  
warm  
WHITE  
250lm



9 002759 324322



L 685

### 32433 BUZZ-LED

spot; steel, black  
Spot; Stahl, schwarz  
spot; acier, noir

L 1050, B 65



GU10



6x 2,8W



6x  
warm  
WHITE  
250lm



9 002759 324339



L 1050



33184

LED



33185

LED



33186

LED

### 33184 BUZZ-LED

spot; steel, brushed brass  
Spot; Stahl, messing-gebürstet  
spot; acier, laiton brossé

Ø 60



GU10



1x 2,8W



1x  
250lm

### 33185 BUZZ-LED

spot; steel, brushed brass  
Spot; Stahl, messing-gebürstet  
spot; acier, laiton brossé

L 285, B 65



GU10



2x 2,8W



2x  
250lm

### 33186 BUZZ-LED

spot; steel, brushed brass  
Spot; Stahl, messing-gebürstet  
spot; acier, laiton brossé

L 485, B 65



GU10



3x 2,8W



3x  
250lm



9 002759 331849



Ø 60



9 002759 331856



L 285

B 65



9 002759 331863



L 485

B 65



33187

LED

### 33187 BUZZ-LED

spot; steel, brushed brass  
Spot; Stahl, messing-gebürstet  
spot; acier, laiton brossé

L 685, B 65



GU10



4x 2,8W



warm  
WHITE  
4x  
250lm



9 002759 331870

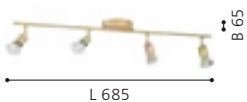



92642

LED



92641

LED





92643

LED

**92641 MAGNUM-LED**

spot; steel, satin nickel, chrome  
Spot; Stahl, nickel-matt, chrom  
spot; acier, nickel mat, chrome



Ø 70



  
 GU10 1x 2,8W 1x 250lm

**92642 MAGNUM-LED**

spot; steel, satin nickel, chrome  
Spot; Stahl, nickel-matt, chrom  
spot; acier, nickel mat, chrome



L 330, B 105



  
 GU10 2x 2,8W 2x 250lm

**92643 MAGNUM-LED**

spot; steel, satin nickel, chrome  
Spot; Stahl, nickel-matt, chrom  
spot; acier, nickel mat, chrome

L 255, H 295

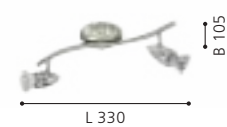

  
 GU10 3x 2,8W 3x 250lm





95824

LED



92644

LED



92645

LED

### 95824 MAGNUM LED

spot; steel, satin nickel, chrome  
Spot; Stahl, nickel-matt, chrom  
spot; acier, nickel mat, chrome

Ø 180

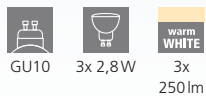

GU10 3x 2,8W 3x 250lm



9 002759 958244



Ø 180

### 92644 MAGNUM-LED

spot; steel, satin nickel, chrome  
Spot; Stahl, nickel-matt, chrom  
spot; acier, nickel mat, chrome

L 645, B 105

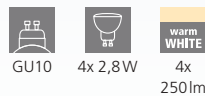

GU10 4x 2,8W 4x 250lm



9 002759 926441



L 645

### 92645 MAGNUM-LED

spot; steel, satin nickel, chrome  
Spot; Stahl, nickel-matt, chrom  
spot; acier, nickel mat, chrome

L 1050

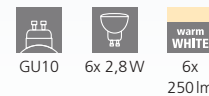

GU10 6x 2,8W 6x 250lm



9 002759 926458



L 1050



93359

LED



93085

LED



93358

93359



94609

### 93085 CABO 1

wall/ceiling light; steel, chrome / satin glass, white, clear  
Wand- / Deckenleuchte; Stahl, chrom / Glas satiniert, weiss, klar  
Applique/Plafonnier; acier, chrome / verre satiné, blanc, transparent

H 100, Ø 290



GU10



4x 2,8W



4x  
warm  
WHITE  
250lm



9 002759 930851

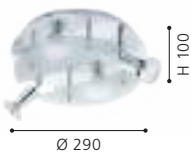

Ø 290

### 93359 VILANOVA

system; aluminium, steel, aluminium, chrome  
System; Alu, Stahl, alu, chrom  
système; aluminium, acier, aluminium, chrome

L 2000, H 200



GU10



5x 2,8W



5x  
warm  
WHITE  
250lm



9 002759 933593

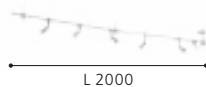

L 2000

### 94609 VILANOVA

accessory; steel, satin nickel  
Zubehör; Stahl, nickel-matt  
Accessoires; acier, nickel mat

L 395



9 002759 946098

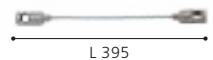

L 395



93358

LED

### 93358 VILANOVA

system; aluminium, steel, aluminium, chrome / glass, white, clear  
 System; Alu, Stahl, alu, chrom / Glas, weiss, klar  
 système; aluminium, acier, aluminium, chrome / verre, blanc, transparent

L 2000, H 200



GU10



5x 4,6W



5x  
 warm  
 WHITE  
 400lm



9 002759 933586



INCL.



L 2000

### 94609

Set to connect 93359 and 93358 tracks:  
 › 250mm Kabel  
 › 2 end parts  
 › 1 straight connector for direct connection

Verbindungsset für 93359 und 93358 Schienen:  
 › 250mm Kabel  
 › 2 Endstücke  
 › 1 Verbinder für eine direkte Verbindung

Set de connexion pour rails 93359 et 93358:  
 › câble de 250mm  
 › 2 pièces d'about  
 › 1 connecteur pour une connexion directe





96182

LED



96178

LED



96179

LED

### 96182 CARDILLO 1

spot; aluminium, steel, aluminium, chrome / plastic, satin finish  
Spot; Alu, Stahl, alu, chrom / Kunststoff, satiniert  
spot; aluminium, acier, aluminium, chrome / plastique, satiné

L 985, B 85

LED warm WHITE LED warm WHITE

4x 3,2W 1760lm 2x 3,3W 800lm



9 002759 961824



### 96178 CARDILLO 1

spot; aluminium, steel, aluminium, chrome / plastic, satin finish  
Spot; Alu, Stahl, alu, chrom / Kunststoff, satiniert  
spot; aluminium, acier, aluminium, chrome / plastique, satiné

L 225, B 65

LED warm WHITE LED warm WHITE

1x 3,2W 440lm 1x 2,2W 260lm



9 002759 961787



### 96179 CARDILLO 1

spot; aluminium, steel, aluminium, chrome / plastic, satin finish  
Spot; Alu, Stahl, alu, chrom / Kunststoff, satiniert  
spot; aluminium, acier, aluminium, chrome / plastique, satiné

L 390, B 85

LED warm WHITE LED warm WHITE

2x 3,2W 880lm 1x 3,3W 400lm



9 002759 961794

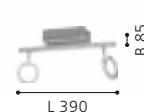





96181



96183



### 96181 CARDILLIO 1

spot; aluminium, steel, aluminium, chrome / plastic, satin finish  
 Spot; Alu, Stahl, alu, chrom / Kunststoff, satiniert  
 spot; aluminium, acier, aluminium, chrome / plastique, satiné

L 690, B 85



3x 3,2W 1320lm 2x 3,3W 800lm



9 002759 961817

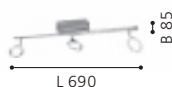

### 96183 CARDILLIO 1

spot; aluminium, steel, aluminium, chrome / plastic, satin finish  
 Spot; Alu, Stahl, alu, chrom / Kunststoff, satiniert  
 spot; aluminium, acier, aluminium, chrome / plastique, satiné

L 1585, B 85



6x 3,2W 2640lm 3x 3,3W 1200lm



9 002759 961831

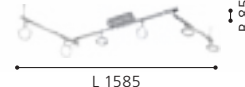

### CARDILLIO 1

These luminaires have different lighting sources. Profil lights combined with spot heads create basic lighting as well as accent lighting.

Diese Leuchten verfügen über unterschiedliche Lichtquellen. Profilleuchten kombiniert mit Spotköpfen schaffen sowohl Grundlicht als auch Akzentbeleuchtung.

Ces luminaires ont des sources d'éclairage différentes. La combinaison entre un éclairage sur la base du produit et un spot vous permet d'avoir un éclairage général mais aussi directionnel.



900516

LED



900513

LED

### 900516 CARDILLIO 2

spot; aluminium, steel, black / plastic, satin finish  
Spot; Alu, Stahl, schwarz / Kunststoff, satiniert  
spot; aluminium, acier, noir / plastique, satiné

L 985, B 85, H 175

LED warm WHITE LED warm WHITE

4x 3,2W 1600lm 2x 3,3W 720lm



9 008606 244454



L 985

### 900513 CARDILLIO 2

spot; aluminium, steel, black / plastic, satin finish  
Spot; Alu, Stahl, schwarz / Kunststoff, satiniert  
spot; aluminium, acier, noir / plastique, satiné

L 225, B 65, H 165

LED warm WHITE LED warm WHITE

1x 3,2W 400lm 1x 2,2W 240lm



9 008606 244423



L 225



### 900514 CARDILLIO 2

spot; aluminium, steel, black / plastic, satin finish  
Spot; Alu, Stahl, schwarz / Kunststoff, satiniert  
spot; aluminium, acier, noir / plastique, satiné

L 385, B 85, H 175



### 900515 CARDILLIO 2

spot; aluminium, steel, black / plastic, satin finish  
Spot; Alu, Stahl, schwarz / Kunststoff, satiniert  
spot; aluminium, acier, noir / plastique, satiné

L 385, B 85, H 175



### 900839 CARDILLIO 1

spot; aluminium, steel, black / plastic, satin finish  
Spot; Alu, Stahl, schwarz / Kunststoff, satiniert  
spot; aluminium, acier, noir / plastique, satiné

L 1585, B 85, H 200





95629

LED



DESIGN  
HIGHLIGHT  
DETAIL

### 95629 SALTO

spot; steel, chrome / plastic, satin finish  
Spot; Stahl, chrom / Kunststoff, satiniert  
spot; acier, chrome / plastique, satiné

L 360, B 120

LED

2x 5,4W

warm  
WHITE

2x  
640lm



9 002759 956295



L 360

B 120



95631



95632



**95631 SALTO**

spot; steel, chrome / plastic, satin finish  
 Spot; Stahl, chrom / Kunststoff, satiniert  
 spot; acier, chrome / plastique, satiné

L 560, B 130



3x 5,4W

3x  
640lm

**95632 SALTO**

spot; steel, chrome / plastic, satin finish  
 Spot; Stahl, chrom / Kunststoff, satiniert  
 spot; acier, chrome / plastique, satiné

L 760, B 130



4x 5,4W

4x  
640lm



9 002759 956318

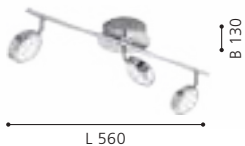

9 002759 956325





# CLIP & PLUG LUMINAIRES

KLEMM- & STECKERLEUCHTEN  
LUMINAIRES À PINCE & SUR PRISE



**EN LIGHT - VIRTUALLY ANYWHERE**

Our clamping and plug-in luminaires inspire with their flexible uses. They serve as pleasant reading lamps or can be positioned for targeted highlighting.

**DE LICHT - PRAKTISCH ÜBERALL**

Unsere Klemm- und Steckerleuchten begeistern durch ihre flexible Verwendbarkeit. Sie dienen als angenehme Lesebeleuchtung oder können zur gezielten Lichtsetzung positioniert werden.

**FR LA LUMIÈRE - PRATIQUE ET PARTOUT**

Nos luminaires à pinces et à fiches ravissent de leurs possibilités flexibles d'utilisation. Ils servent de lumière agréable pour la lecture ou peuvent être positionnés afin d'offrir une lumière ciblée.





# OVERVIEW

CLIP & PLUG LUMINAIRES  
KLEMM- & STECKERLEUCHTEN  
LUMINAIRES À PINCE & SUR PRISE



CABADO  
**776**



FABIO  
**776-777**



RICCIO 1  
**777**



MINI 4  
**778-779**



DAKAR 3  
**778**



This product is available in different colors and shapes. / Dieser Artikel ist in unterschiedlichen Farben und Formen verfügbar. /  
Cet article est disponible en différentes couleurs et formes.







97077

LED



81262

**97077 CABADO**

clamp light; plastic, white  
 Klemmleuchte; Kunststoff, weiss  
 luminaire à pince; plastique, blanc

L 120, B 65, H 420



1,6W



150lm



Li-ion



500mAh



9 002759 970772



L 120

**81262 FABIO**

clamp light; steel, plastic, white, silver  
 Klemmleuchte; Stahl, Kunststoff, weiss, silber  
 luminaire à pince; acier, plastique, blanc, argent

H 300



E14



1x 40W



9 002759 812621



H 300



81265



94329

LED

### 81265 FABIO

clamp light; steel, plastic, silver  
 Klemmleuchte; Stahl, Kunststoff, silber  
 luminaire à pince; acier, plastique, argent

H 300



E14 1x 40W



9 002759 812652



H 300

### 94329 RICCIO 1

clamp light; plastic, steel, white, chrome / steel, white, chrome  
 Klemmleuchte; Kunststoff, Stahl, weiss, chrom / Stahl, weiss, chrom  
 luminaire à pince; plastique, acier, blanc, chrome / acier, blanc, chrome

L 180, H 330



GU10 1x 2,8W 1x 250lm 4



9 002759 943295



H 330

L 180



92924

LED



92925

LED



92935

### 92925 MINI 4

plug-in light; steel, white, chrome  
Steckerleuchte; Stahl, weiss, chrom  
luminaire sur prise; acier, blanc, chrome

L 70, H 100

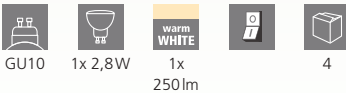

### 92924 MINI 4

plug-in light; steel, satin nickel, chrome  
Steckerleuchte; Stahl, nickel-matt, chrom  
luminaire sur prise; acier, nickel mat, chrome

L 70, H 100

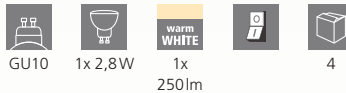

### 92935 DAKAR 3

plug-in light; steel, satin nickel, chrome / plastic, white  
Steckerleuchte; Stahl, nickel-matt, chrom / Kunststoff, weiss  
luminaire sur prise; acier, nickel mat, chrome / plastique, blanc

L 70, H 180, A 280





92933

LED

### 92933 MINI 4

plug-in light; steel, satin nickel, chrome  
Steckerleuchte; Stahl, nickel-matt, chrom  
luminaire sur prise; acier, nickel mat, chrome

L 70, H 180, A 220



GU10



1x 2,8W



1x  
warm  
WHITE  
250lm



4



9 002759 929336



INCL.





# TABLE & FLOOR LUMINAIRES

TISCH- & STEHLEUCHTEN  
LUMINAIRES DE TABLE & LAMPADAIRES

**EN WE LOVE LIGHT**

The range of table and floor luminaires is made up of many different styles and convinces with its diverse uses. The luminaires give your home a comfortable light mood and turn into chic living room accessories.

**DE WIR STEHEN AUF LICHT**

Das Sortiment der Tisch- und Stehleuchten setzt sich aus unterschiedlichen Stilen zusammen und überzeugt mit seinen vielseitigen Einsatzmöglichkeiten. Die Leuchten verleihen Ihrem Zuhause eine gemütliche Lichtstimmung und werden zum schicken Wohnraumaccessoire.

**FR NOUS NOUS TENONS EN PLEINE LUMIÈRE**



















































La gamme de luminaires de table et lampadaires est formée de différents styles et persuade par ses multiples possibilités d'application. Les lampes donnent à votre intérieur une lumière conviviale et se transforment en des accessoires d'habitat chics.





# OVERVIEW

TABLE & FLOOR LUMINAIRES  
TISCH- & STEHLEUCHTEN  
LUMINAIRES DE TABLE & LAMPADAIRES

 PICCOLA 785	 MANNERA 786-787	 FONDACHELLI 788	 CONESA 790	 ESPARTAL 791	 NADINA 791	 ONEDA 792	 CORTADERAS 792
 ARANZOLA 793	 RONDO 4 794	 BELESER 795	 BUDENSEA 796	 CARBONERAS 796	 PICACHA 799	 BORGILLIO 799	 UP 2 800-801
 BAYA LED 802-803	 BAYA 804	 PASTERI 806	 CARLTON 2 807	 MANALBA 1 808	 MANALBA 808	 CHIETINO 1 809	 BELLARIVA 3 809
 TRONDIO 809	 BELLARIVA 810	 CAPALBIO 811	 CAHUAMA 812	 BATISTA 3 813	 TURALDO 1 813	 SWARBY 813	 MURNIA 814
 PETTO 1 814	 BILBANA 815	 BATABANO 815	 ERMUA 815	 SARONA 816	 AMEZAGA 816	 MARYVILLA 817	 CAPRAROLA 817
 CIUDADELA 817	 MADONNINA 818	 SOLO 2 819	 SOLO 1 820	 SOLO 821	 DAMASCO 1 821-822	 SLIM 821	 GEO 823
 NARANJO 825	 DESIERTO 825						



This product is available in different colors and shapes. / Dieser Artikel ist in unterschiedlichen Farben und Formen verfügbar. / Cet article est disponible en différentes couleurs et formes.





Office table & floor luminaires starts on page 826.  
Office Tisch- & Stehleuchten starten auf Seite 826.  
Luminaires de table & lampadaires à bureau commence à la page 826.





900923

LED

HIGH  
IP

IP54



900924



900925



### 900923 PICCOLA

table light; steel, brushed brass / plastic, white  
Tischleuchte; Stahl, messing-gebürstet / Kunststoff, weiss  
luminaire de table; acier, laiton brossé / plastique, blanc

H 280, Ø 130, Base: Ø 70

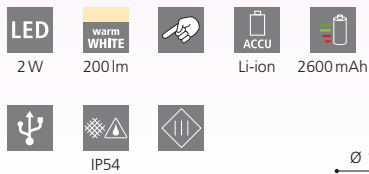

9 008606 277780

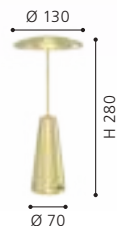

### 900924 PICCOLA

table light; steel, dark bronze / plastic, white  
Tischleuchte; Stahl, bronze dunkel / Kunststoff, weiss  
luminaire de table; acier, bronze foncé / plastique, blanc

H 280, Ø 130, Base: Ø 70

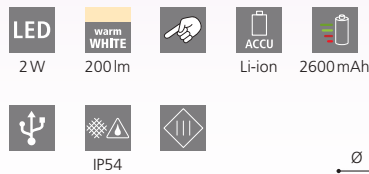

9 008606 277797



### 900925 PICCOLA

table light; steel, black / plastic, white  
Tischleuchte; Stahl, schwarz / Kunststoff, weiss  
luminaire de table; acier, noir / plastique, blanc

H 280, Ø 130, Base: Ø 70

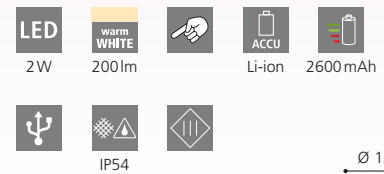

9 008606 277803





900459



IP54



900457



IP54



900461



IP54

### 900459 MANNERA

table light; aluminium, steel, auburn / plastic, white  
Tischleuchte; Alu, Stahl, rostbraun / Kunststoff, weiss  
luminaire de table; aluminium, acier, brun rouille / plastique, blanc

H 340, Ø 110, Base: Ø 110



### 900457 MANNERA

table light; aluminium, steel, black / plastic, white  
Tischleuchte; Alu, Stahl, schwarz / Kunststoff, weiss  
luminaire de table; aluminium, acier, noir / plastique, blanc

H 340, Ø 110, Base: Ø 110



### 900461 MANNERA

table light; aluminium, steel, sandy / plastic, white  
Tischleuchte; Alu, Stahl, sandfarben / Kunststoff, weiss  
luminaire de table; aluminium, acier, couleur sable / plastique, blanc

H 340, Ø 110, Base: Ø 110





900458



## 900458 MANNERA

table light; aluminium, steel, grey / plastic, white  
 Tischleuchte; Alu, Stahl, grau / Kunststoff, weiss  
 luminaire de table; aluminium, acier, gris / plastique, blanc

H 340, Ø 110, Base: Ø 110

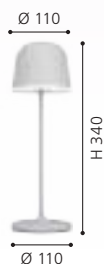
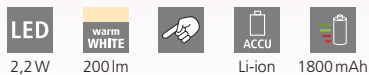



**95539**



**95541**

**95539 FONDACHELLI**

floor light; steel, satin nickel / fabric, white, silver  
 Stehleuchte; Stahl, nickel-matt / Textil, weiss, silber  
 lampadaire; acier, nickel mat / tissu, blanc, argent

H 1515, Ø 510



E27 1x 60W

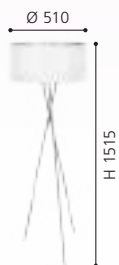

9 002759 955397

**95541 FONDACHELLI**

floor light; steel, black / fabric, black, copper  
 Stehleuchte; Stahl, schwarz / Textil, schwarz, kupfer  
 lampadaire; acier, noir / tissu, noir, cuivre

H 1515, Ø 510

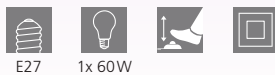

E27 1x 60W



9 002759 955410

**900187 FONDACHELLI**

floor light; steel, black / fabric, linen, grey  
 Stehleuchte; Stahl, schwarz / Textil, Leinen, grau  
 lampadaire; acier, noir / tissu, lin, gris

H 1515, Ø 510

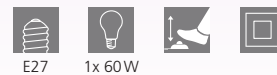

E27 1x 60W

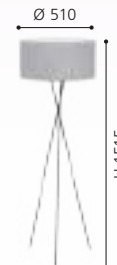

9 008606 234479



900187



95686



98309

LED

### 95686 CONESA

floor light; steel, satin nickel / fabric, glass, white  
 Stehleuchte; Stahl, nickel-matt / Textil, Glas, weiss  
 lampadaire; acier, nickel mat / tissu, verre, blanc

H 1700, Ø 380, Base: Ø 230



E27



1x 60W



E14



1x 40W



9 002759 956868







92206



### 98309 ESPARTAL

floor light; steel, aluminium, satin nickel, aluminium / fabric, white

Stehleuchte; Stahl, Alu, nickel-matt, alu / Textil, weiss

lampadaire; acier, aluminium, nickel mat, aluminium / tissu, blanc

H 1485, Ø 250, Base: Ø 250



E27 1x 60W 11,8W 1650lm



9 002759 983093



### 92206 NADINA

floor light; steel, satin nickel / textile with velcro, white

Stehleuchte; Stahl, nickel-matt / Textil mit Klettverschluss, weiss

lampadaire; acier, nickel mat / tissu avec fermeture velcro, blanc

L 1790, B 380, H 1950, Base: Ø 320

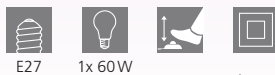

E27 1x 60W

L 1790



9 002759 922061





**900393**



**900394**



**97806**

LED

**900393 ONEDA**

table light; steel, black, white  
Tischleuchte; Stahl, schwarz, weiss  
luminaire de table; acier, noir, blanc

L 290, B 145, H 445, Base: Ø 210



**900394 ONEDA**

floor light; steel, black, white  
Stehleuchte; Stahl, schwarz, weiss  
lampadaire; acier, noir, blanc

L 540, B 200, H 1605, Base: Ø 315

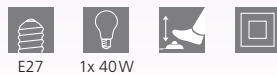

**97806 CORTADERAS**

floor light; steel, black, gold  
Stehleuchte; Stahl, schwarz, gold  
lampadaire; acier, noir, or

H 1445, Ø 250, Base: Ø 250

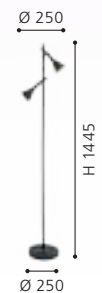



**900134**



**900135**

**900134 ARANZOLA**

table light; steel, black, white  
Tischleuchte; Stahl, schwarz, weiss  
luminaire de table; acier, noir, blanc

H 450, Ø 300, Base: Ø 115



E27 1x 40W



9 008606 240012



**900135 ARANZOLA**

floor light; steel, black, white  
Stehleuchte; Stahl, schwarz, weiss  
lampadaire; acier, noir, blanc

L 300, H 1635, Base: Ø 300

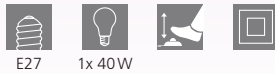

E27 1x 40W



9 008606 240029

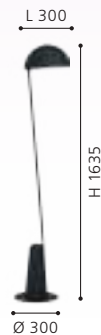

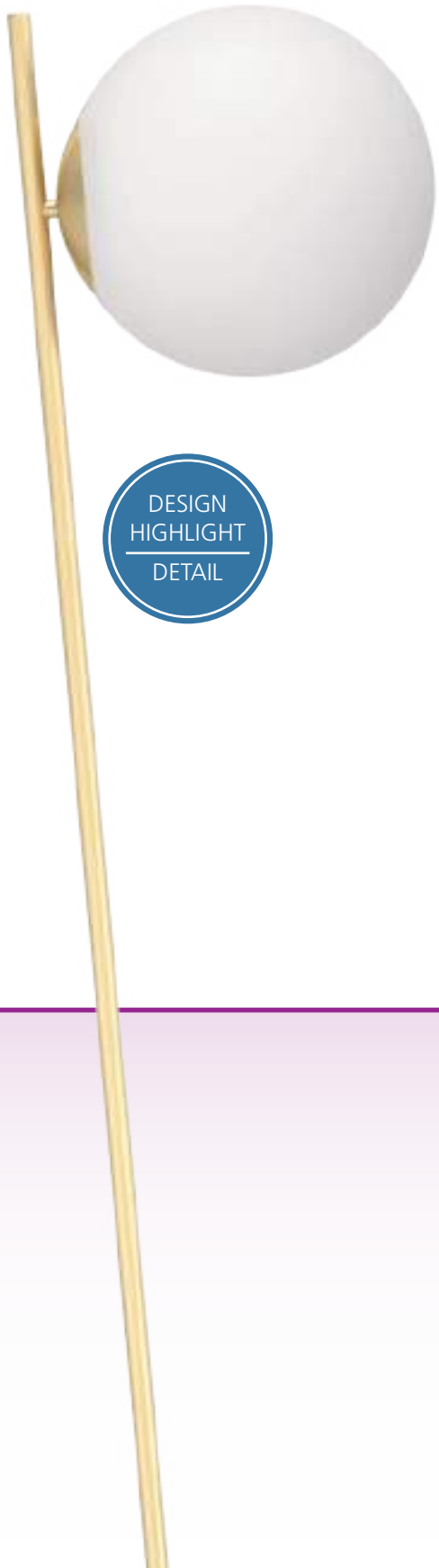

DESIGN  
HIGHLIGHT  
DETAIL



**900868**



EGLO  
RECOMMENDS  
**110033**

RONDO 4

**900869**

**900868 RONDO 4**

table light; steel, brushed brass / matte-opal glass, white  
Tischleuchte; Stahl, messing-gebürstet / Glas opal-matt, weiss  
luminaire de table; acier, laiton brossé / verre opale mat, blanc

L 230, B 180, H 565, Base: Ø 215



E27 1x 40W



9 008606 274444



**900869 RONDO 4**

floor light; steel, brushed brass / matte-opal glass, white  
Stehleuchte; Stahl, messing-gebürstet / Glas opal-matt, weiss  
lampadaire; acier, laiton brossé / verre opale mat, blanc

L 355, B 250, H 1745, Base: Ø 300



E27 1x 40W



9 008606 274451





**98386**



**98387**



### 98386 BELESER

table light; steel, black / glass vaporized, black-transparent  
Tischleuchte; Stahl, schwarz / Glas bedampft, schwarz-transparent  
luminaire de table; acier, noir / verre vaporisé, noir transparent

L 265, B 205, H 505, Base: Ø 200

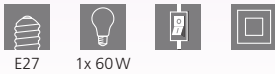

### 98387 BELESER

floor light; steel, black / glass vaporized, black-transparent  
Stehleuchte; Stahl, schwarz / Glas bedampft, schwarz-transparent  
lampadaire; acier, noir / verre vaporisé, noir transparent

L 260, B 205, H 1505, Base: Ø 220

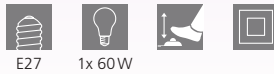



### 99113

These luminaires are rotatable.  
 Diese Leuchten sind drehbar.  
 Ces luminaires sont orientables.

0-180°

0-80°



### 99113

LED



### 99822

The heads of this luminaires can be switched and dimmed separately.  
 Die Köpfe dieser Leuchten sind getrennt voneinander schaltbar und dimmbar.  
 Les têtes de ce luminaires peuvent être commutées et gradées séparément.

## 99113 BUDENSEA

floor light; cast aluminium, black, white  
 Stehleuchte; Aluguss, schwarz, weiss  
 lampadaire; fonte d'aluminium, noir, blanc

L 365, B 250, H 1800, Base: B 300, T 250



GU10



2x 4,5W



2x  
 warm  
 WHITE  
 345lm



9 002759 991135

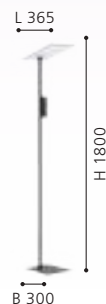

## 99822 CARBONERAS

floor light; steel, black / plastic, transparent  
 Stehleuchte; Stahl, schwarz / Kunststoff, transparent  
 lampadaire; acier, noir / plastique, transparent

L 400, B 250, H 1800, Base: B 330, T 240



6x 3,8W



warm  
 WHITE  
 2400lm



7W



warm  
 WHITE  
 750lm



9 002759 998226

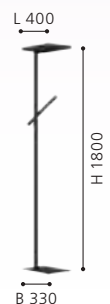



99822

LED



99715

LED





**94698**



**94705**

### 99715 PICACHA

floor light; steel, black / plastic, white  
 Stehleuchte; Stahl, schwarz / Kunststoff, weiss  
 lampadaire; acier, noir / plastique, blanc

H 1625, Base: B 150, T 150



29W 3500lm



9 002759 997151



### 94698 BORGILLO

floor light; steel, black  
 Stehleuchte; Stahl, schwarz  
 lampadaire; acier, noir

L 380, H 1900, Base: Ø 340

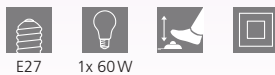

E27 1x 60W



9 002759 946982

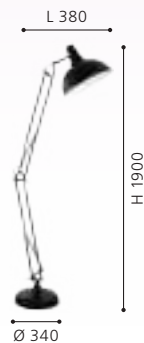

### 94705 BORGILLO

floor light; steel, copper  
 Stehleuchte; Stahl, kupfer  
 lampadaire; acier, cuivre

L 380, H 1900, Base: Ø 340

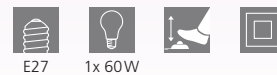

E27 1x 60W



9 002759 947057





**93917**



**82842**



**82843**

### 93917 UP 2

floor light; steel, nickel-nero / plastic, glass, white  
 Stehleuchte; Stahl, nickel-nero / Kunststoff, Glas, weiss  
 lampadaire; acier, nickel noir / plastique, verre, blanc

H 1765, Ø 275, Base: Ø 230

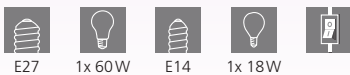

### 82842 UP 2

floor light; steel, satin nickel / plastic, glass, white  
 Stehleuchte; Stahl, nickel-matt / Kunststoff, Glas, weiss  
 lampadaire; acier, nickel mat / plastique, verre, blanc

H 1765, Ø 275, Base: Ø 230

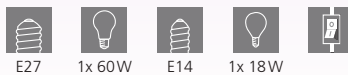

### 82843 UP 2

floor light; steel, matte brass / plastic, glass, white  
 Stehleuchte; Stahl, messing-matt / Kunststoff, Glas, weiss  
 lampadaire; acier, laiton mat / plastique, verre, blanc

H 1765, Ø 275, Base: Ø 230

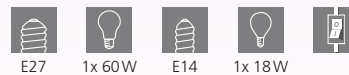



82844

DESIGN  
HIGHLIGHT  
DETAIL



### 82844 UP 2

floor light; steel, bronzed / plastic, glass, white  
Stehleuchte; Stahl, brüniert / Kunststoff, Glas, weiss  
lampadaire; acier, brun / plastique, verre, blanc

H 1765, Ø 275, Base: Ø 230



E27



1x 60W



E14



1x 18W



9 002759 828448





93877



93876



93875



### 93877 BAYA LED

floor light; steel, brass / glass, plastic, white, satin finish  
 Stehleuchte; Stahl, messing / Glas, Kunststoff, weiss, satiniert  
 lampadaire; acier, laiton / verre, plastique, blanc, satiné

L 360, H 1800, Base: Ø 250

LED 20W warm WHITE 1950lm LED 2,5W warm WHITE 240lm LED 2,5W

warm WHITE 250lm



9 002759 938772



### 93876 BAYA LED

floor light; steel, bronzed / glass, plastic, white, satin finish  
 Stehleuchte; Stahl, brüniert / Glas, Kunststoff, weiss, satiniert  
 lampadaire; acier, brun / verre, plastique, blanc, satiné

L 360, H 1800, Base: Ø 250

LED 20W warm WHITE 1950lm LED 2,5W warm WHITE 240lm LED 2,5W

warm WHITE 250lm



9 002759 938765



### 93875 BAYA LED

floor light; steel, chrome / glass, plastic, white, satin finish  
 Stehleuchte; Stahl, chrom / Glas, Kunststoff, weiss, satiniert  
 lampadaire; acier, chrome / verre, plastique, blanc, satiné

L 360, H 1800, Base: Ø 250

LED 20W warm WHITE 1950lm LED 2,5W warm WHITE 240lm LED 2,5W

warm WHITE 250lm



9 002759 938758





DESIGN  
HIGHLIGHT  
DETAIL

### 93874 BAYA LED

floor light; steel, satin nickel / glass, plastic, white, satin finish  
Stehleuchte; Stahl, nickel-matt / Glas, Kunststoff, weiss, satiniert  
lampadaire; acier, nickel mat / verre, plastique, blanc, satiné

L 360, H 1800, Base: Ø 250

<b>LED</b> 20W	<b>warm WHITE</b> 2200lm	<b>LED</b> 2,5W	<b>warm WHITE</b> 250lm	<b>LED</b> 2,5W
-------------------	-----------------------------	--------------------	----------------------------	--------------------

<b>warm WHITE</b> 250lm				
----------------------------	--	--	--	--



93874

LED



DESIGN  
HIGHLIGHT  
DETAIL



85974

### 85974 BAYA

floor light; steel, bronzed / satin glass, white  
Stehleuchte; Stahl, brüniert / Glas satiniert, weiss  
lampadaire; acier, brun / verre satiné, blanc

L 440, H 1800, Base: Ø 280



R7S 1x 230W G9 1x 33W



### 85971 BAYA

floor light; steel, satin nickel / satin glass, white  
Stehleuchte; Stahl, nickel-matt / Glas satiniert, weiss  
lampadaire; acier, nickel mat / verre satiné, blanc

L 440, H 1800, Base: Ø 280



R7S 1x 230W G9 1x 33W





85971



**95726**



**95725**

**95726 PASTERI**

table light; steel, satin nickel / fabric, taupe  
 Tischleuchte; Stahl, nickel-matt / Textil, taupe  
 luminaire de table; acier, nickel mat / tissu, taupe

H 275, Ø 140, Base: Ø 120



**95725 PASTERI**

table light; steel, satin nickel / fabric, white  
 Tischleuchte; Stahl, nickel-matt / Textil, weiss  
 luminaire de table; acier, nickel mat / tissu, blanc

H 275, Ø 140, Base: Ø 120







95789



95787



95788

### 95789 CARLTON 2

table light; steel, black / fabric, white  
Tischleuchte; Stahl, schwarz / Textil, weiss  
luminaire de table; acier, noir / tissu, blanc

H 305, Ø 165, Base: Ø 95

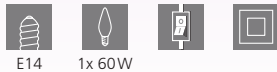

E14 1x 60W



9 002759 957896



### 95787 CARLTON 2

table light; steel, copper / fabric, black, copper  
Tischleuchte; Stahl, kupfer / Textil, schwarz, kupfer  
luminaire de table; acier, cuivre / tissu, noir, cuivre

H 305, Ø 165, Base: Ø 95



E14 1x 60W



9 002759 957872



### 95788 CARLTON 2

table light; steel, brass / fabric, black, gold  
Tischleuchte; Stahl, messing / Textil, schwarz, gold  
luminaire de table; acier, laiton / tissu, noir, or

H 305, Ø 165, Base: Ø 95

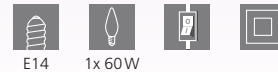

E14 1x 60W



9 002759 957889





99329



99331



95386

### 99329 MANALBA 1

table light; ceramic, silver / fabric, white, silver  
Tischleuchte; Keramik, silber / Textil, weiss, silber  
luminaire de table; céramique, argent / tissu, blanc, argent

H 300, Ø 200, Base: Ø 125



E14 1x 40W



9 002759 993290



### 99331 MANALBA 1

table light; ceramic, gold-coloured / fabric, black, gold  
Tischleuchte; Keramik, goldfarben / Textil, schwarz, gold  
luminaire de table; céramique, or / tissu, noir, or

H 300, Ø 200, Base: Ø 125



E14 1x 40W



9 002759 993313



### 95386 MANALBA

table light; steel, gold / fabric, black, gold  
Tischleuchte; Stahl, gold / Textil, schwarz, gold  
luminaire de table; acier, or / tissu, noir, or

H 380, Ø 250, Base: Ø 160

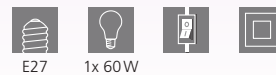

E27 1x 60W



9 002759 953867





97516



99332



93046

### 97516 CHIETINO 1

table light; wood, steel, natural, chrome / fabric, white  
Tischleuchte; Holz, Stahl, natur, chrom / Textil, weiss  
luminaire de table; bois, acier, naturel, chrome / tissu, blanc

H 440, Ø 260, Base: B 235, T 235

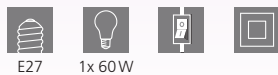

E27 1x 60W



9 002759 975166

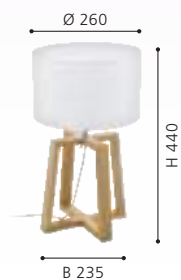

### 99332 BELLARIVA 3

table light; ceramic, white / fabric, linen, light brown  
Tischleuchte; Keramik, weiss / Textil, Leinen, hellbraun  
luminaire de table; céramique, blanc / tissu, lin, marron transparent

H 360, Ø 200, Base: Ø 160



E27 1x 40W



9 002759 993320



### 93046 TRONDIO

table light; ceramic, white / fabric, white  
Tischleuchte; Keramik, weiss / Textil, weiss  
luminaire de table; céramique, blanc / tissu, blanc

H 270, Ø 150, Base: Ø 120

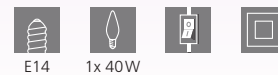

E14 1x 40W



9 002759 930462





**97774**



**97773**



**97774 BELLARIVA**

table light; ceramic, grey / fabric, white  
Tischleuchte; Keramik, grau / Textil, weiss  
luminaire de table; céramique, gris / tissu, blanc

H 320, Ø 150, Base: Ø 120

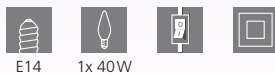

E14 1x 40W



**97773 BELLARIVA**

table light; ceramic, cream-white / fabric, white  
Tischleuchte; Keramik, creme-weiss / Textil, weiss  
luminaire de table; céramique, blanc crème / tissu, blanc

H 320, Ø 150, Base: Ø 120



E14 1x 40W





CAPALBIO



900824



900823

### 900824 CAPALBIO

table light; ceramic, grey / fabric, linen, natural  
Tischleuchte; Keramik, grau / Textil, Leinen, natur  
luminaire de table; céramique, gris / tissu, lin, nature

H 410, Ø 230, Base: Ø 120

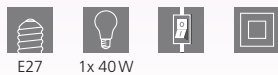

E27 1x 40W



9 008606 274017



### 900823 CAPALBIO

table light; ceramic, sandy / fabric, white  
Tischleuchte; Keramik, sandfarben / Textil, weiss  
luminaire de table; céramique, couleur sable / tissu, blanc

H 410, Ø 230, Base: Ø 120

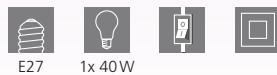

E27 1x 40W



9 008606 274000





99824



99825

### 99824 CAHUAMA

table light; ceramic, light brown / glass, white  
Tischleuchte; Keramik, hellbraun / Glas, weiss  
luminaire de table; céramique, marron clair / verre, blanc

H 300, Ø 275, Base: Ø 105



E27 1x 40W



9 002759 998240



### 99825 CAHUAMA

table light; ceramic, white, black / satin glass, grey matt  
Tischleuchte; Keramik, weiss, schwarz / Glas satiniert, grau matt  
luminaire de table; céramique, blanc, noir / verre satiné, gris mat

H 300, Ø 275, Base: Ø 105



E27 1x 40W



9 002759 998257





97589



97589



900334



98859

### 97589 BATISTA 3

table light; steel, satin nickel / glass wiping technique, white  
Tischleuchte; Stahl, nickel-matt / Glas Wischtechnik, weiss  
luminaire de table; acier, nickel mat / technique de verre essuyé, blanc

H 225, Ø 120, Base: Ø 110



E27 1x 40W



9 002759 975890



### 900334 TURIALDO 1

table light; wood, steel, black  
Tischleuchte; Holz, Stahl, schwarz  
luminaire de table; bois, acier, noir

H 100, Ø 85



E27 1x 28W



9 008606 235636



### 98859 SWARBY

table light; cement, grey  
Tischleuchte; Zement, grau  
luminaire de table; ciment, gris

H 120, Ø 100

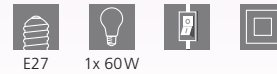

E27 1x 60W



9 002759 988593





900314



94513

LED

DESIGN  
HIGHLIGHT  
DETAIL



**900314 MURNIA**

table light; steel, black, white  
Tischleuchte; Stahl, schwarz, weiss  
luminaire de table; acier, noir, blanc

L 190, B 165, H 430, Base: Ø 165



**94513 PETTO 1**

table light; steel, white  
Tischleuchte; Stahl, weiss  
luminaire de table; acier, blanc

H 135, Ø 105, Base: Ø 90







**900358**



**900396**



**98837**



### 900358 BILBANA

table light; steel, black / matte-opal glass, white  
Tischleuchte; Stahl, schwarz / Glas opal-matt, weiss  
luminaire de table; acier, noir / verre opale mat, blanc

L 145, B 135, H 195, Base: B 135, T 115



E14 1x 40W



9 008606 241071



### 900396 BATABANO

table light; steel, sandy, black  
Tischleuchte; Stahl, sandfarben, schwarz  
luminaire de table; acier, couleur sable, noir

H 275, Ø 180, Base: Ø 160



E27 1x 40W



9 008606 243730



### 98837 ERMUA

table light; steel, wood, black, brown / plastic, white  
Tischleuchte; Stahl, Holz, schwarz, braun / Kunststoff, weiss  
luminaire de table; acier, bois, noir, marron / plastique, blanc

L 330, B 165, H 505, Base: B 240, T 160



LED warm WHITE 4,5W 480lm



9 002759 988371





900403

LED



98864

### 900403 SARONA

table light; steel, black, gold  
Tischleuchte; Stahl, schwarz, gold  
luminaire de table; acier, noir, or

H 315, Ø 140, Base: B 140



GU10



1x 4,5W



1x

345lm



9 008606 243785



INCL.



### 98864 AMEZAGA

table light; steel, black, brass  
Tischleuchte; Stahl, schwarz, messing  
luminaire de table; acier, noir, laiton

L 355, B 160, H 575, Base: Ø 170



E27



1x 10W



9 002759 988647





900814

The shade colours of these luminaires look very different when switched on and off.

Die Schirmfarben dieser Leuchten sehen im ein- und ausgeschalteten Zustand sehr unterschiedlich aus.

Les couleurs de la teinte de ces luminaires sont très différentes lorsqu'ils sont allumés et éteints.



900552



900814



900898

### 900552 MARYVILLA

table light; steel, bronzed / glass vaporized, clear, gold  
Tischleuchte; Stahl, brüniert / Glas bedampft, klar, gold  
luminaire de table; acier, brun / verre vaporisé, transparent, or

H 230, Ø 170, Base: Ø 130



E27 1x 40W



9 008606 244577



### 900814 CAPRAROLA

table light; steel, brushed brass / satin glass, sandy  
Tischleuchte; Stahl, messing-gebürstet / Glas satiniert, sandfarben  
luminaire de table; acier, laiton brossé / verre satiné, couleur sable

H 460, Ø 200, Base: Ø 155

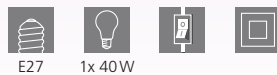

E27 1x 40W



9 008606 274345



### 900898 CIUADELA

table light; steel, black / steel, fabric, brushed brass, white  
Tischleuchte; Stahl, schwarz / Stahl, Textil, messing-gebürstet, weiss  
luminaire de table; acier, noir / acier, tissu, laiton brossé, blanc

L 230, B 180, H 500, Base: Ø 170

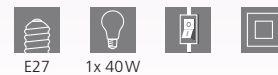

E27 1x 40W



9 008606 274697





**900945**



**900946**



DESIGN  
HIGHLIGHT  
DETAIL

**900945 MADONNINA**

table light; steel, black / glass vaporized, grey  
Tischleuchte; Stahl, schwarz / Glas bedampft, grau  
luminaire de table; acier, noir / verre vaporisé, gris

H 270, Ø 330, Base: Ø 150



E27 1x 40W



9 008606 274963



**900946 MADONNINA**

table light; steel, black / glass vaporized, grey  
Tischleuchte; Stahl, schwarz / Glas bedampft, grau  
luminaire de table; acier, noir / verre vaporisé, gris

H 325, Ø 250, Base: Ø 130



E27 1x 40W



9 008606 274970





900141



900142

### 900141 SOLO 2

table light; steel, black / glass vaporized, black-transparent  
Tischleuchte; Stahl, schwarz / Glas bedampft, schwarz-transparent  
luminaire de table; acier, noir / verre vaporisé, noir transparent

H 415, Ø 260, Base: Ø 180



E27 1x 40W



9 008606 235346



### 900142 SOLO 2

table light; steel, black / etched glass, white  
Tischleuchte; Stahl, schwarz / Glas geätzt, weiss  
luminaire de table; acier, noir / verre gravé, blanc

H 415, Ø 260, Base: Ø 180



E27 1x 40W



9 008606 235353





**87254**



**87256**



**85104**

### 87254 SOLO 1

table light; steel, matte brass / satin glass, white  
Tischleuchte; Stahl, messing-matt / Glas satiniert, weiss  
luminaire de table; acier, laiton mat / verre satiné, blanc

H 350, Ø 260, Base: Ø 130



E14 1x 40W



9 002759 872540



### 87256 SOLO 1

table light; steel, wood, bronzed, nut / satin glass, white  
Tischleuchte; Stahl, Holz, brüniert, Nuss / Glas satiniert, weiss  
luminaire de table; acier, bois, brun, noisette / verre satiné, blanc

H 350, Ø 260, Base: Ø 130



E14 1x 40W



9 002759 872564



### 85104 SOLO 1

table light; steel, satin nickel / satin glass, white  
Tischleuchte; Stahl, nickel-matt / Glas satiniert, weiss  
luminaire de table; acier, nickel mat / verre satiné, blanc

H 350, Ø 260, Base: Ø 130

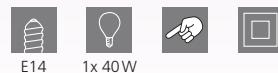

E14 1x 40W



9 002759 851040





**91238**



95785



**95785**



82305



**82305**

### 91238 SOLO

table light; steel, satin nickel / satin glass, white with decoration  
Tischleuchte; Stahl, nickel-matt / Glas satiniert, weiss m. Dekor  
luminaire de table; acier, nickel mat / verre satiné, blanc avec décor

H 320, Ø 265, Base: Ø 130



E14 1x 60W



9 002759 912383



### 95785 DAMASCO 1

table light; steel, satin nickel / matte-opal glass, white  
Tischleuchte; Stahl, nickel-matt / Glas opal-matt, weiss  
luminaire de table; acier, nickel mat / verre opale mat, blanc

H 300, Ø 145, Base: Ø 120



E14 1x 60W



9 002759 957858



### 82305 SLIM

table light; steel, satin nickel / glass, white  
Tischleuchte; Stahl, nickel-matt / Glas, weiss  
luminaire de table; acier, nickel mat / verre, blanc

H 220, Ø 70, Base: Ø 100

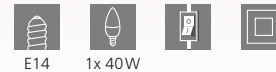

E14 1x 40W



9 002759 823054





81828 | 95775 | 95776



95775



95776



98887

### 95775 DAMASCO 1

table light; steel, satin nickel / satin glass, white  
Tischleuchte; Stahl, nickel-matt / Glas satiniert, weiss  
luminaire de table; acier, nickel mat / verre satiné, blanc

H 215, Ø 100

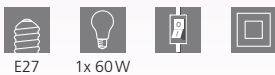

9 002759 957759



### 95776 DAMASCO 1

table light; steel, chrome / satin glass, white  
Tischleuchte; Stahl, chrom / Glas satiniert, weiss  
luminaire de table; acier, chrome / verre satiné, blanc

H 215, Ø 100

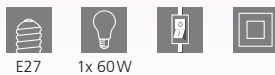

9 002759 957766



### 98887 DAMASCO 1

table light; steel, black / glass vaporized, black-transparent  
Tischleuchte; Stahl, schwarz / Glas bedampft, schwarz-transparent  
luminaire de table; acier, noir / verre vaporisé, noir transparent

H 310, Ø 100



9 002759 988876







81827 | 91242



**81827**



**81828**



**91242**

### 81827 GEO

table light; glass, plastic, white  
Tischleuchte; Glas, Kunststoff, weiss  
luminaire de table; verre, plastique, blanc

H 200, Ø 100, Base: Ø 100

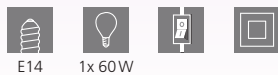

E14 1x 60W



9 002759 818272



### 81828 GEO

table light; matte-opal glass, white  
Tischleuchte; Glas opal-matt, weiss  
luminaire de table; verre opale mat, blanc

H 350, Ø 120, Base: Ø 120



E27 1x 60W



9 002759 818289



### 91242 GEO

table light; glass, plastic, white  
Tischleuchte; Glas, Kunststoff, weiss  
luminaire de table; verre, plastique, blanc

H 200, Ø 100

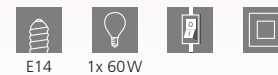

E14 1x 60W



9 002759 912420





99597

LED

DESIGN  
HIGHLIGHT  
DETAIL



99794



**99597 NARANJO**

table light; steel, black / glass, clear  
Tischleuchte; Stahl, schwarz / Glas, klar  
luminaire de table; acier, noir / verre, transparent

L 450, B 430, H 555



4x 4,5W 2200lm



9 002759 995973



**99794 DESIERTO**

table light; steel, wood, black, brown  
Tischleuchte; Stahl, Holz, schwarz, braun  
luminaire de table; acier, bois, noir, marron

H 540, Ø 450, Base: Ø 330

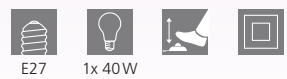

E27 1x 40W



9 002759 997946





# OFFICE TABLE & FLOOR LUMINAIRES

OFFICE TISCH- & STEHLEUCHTEN  
LUMINAIRES DE TABLE & LAMPADAIRES À BUREAU



**EN WE LOVE LIGHT**

The range of office table and floor luminaires is made up of many different styles and convinces with its diverse uses.

**DE WIR STEHEN AUF LICHT**

Das Sortiment der Büro Tisch- und Stehleuchten setzt sich aus unterschiedlichen Stilen zusammen und überzeugt mit seinen vielseitigen Einsatzmöglichkeiten.

**FR NOUS NOUS TENONS EN PLEINE LUMIÈRE**

La gamme d'éclairages de table et sur pieds à bureau est formée de différents styles et persuade par ses multiples possibilités d'application.





# OVERVIEW

OFFICE TABLE & FLOOR LUMINAIRES  
OFFICE TISCH- & STEHLEUCHTEN  
LUMINAIRES DE TABLE & LAMPADAIRES À BUREAU

 TRUNCA 830	 MASSERIE 830	 ARENAZA 831	 BANDERALO 832	 LACEY-QI 833	 VERADAL-QI 833	 INIESTA 834	 SELLANO 836
 LA SECA 837	 CAUPO 838	 BROLINI 839	 COGNOLI 840	 LAROJA 842-843	 VERADAL 844	 CEPPINO 844-845	 DURENGO 846
 DAMBERA 846	 SNAPORA 846	 GEXO 848	 CABALES 848-849	 CAJERO 850-851	 CABADO 1 851	 TORONA 1 852	 TABILLANO 1 852
 BORGILLIO 854-855	 BANKER 856	 FIRMO 857	 BASIC 1 858	 BASIC 858-859	 FOX 860		



This product is available in different colors and shapes. / Dieser Artikel ist in unterschiedlichen Farben und Formen verfügbar. / Cet article est disponible en différentes couleurs et formes.



## 98093, 98247, 99828, 99829

These luminaires have a Qi charging function. They can wirelessly charge Qi-compatible Smartphones by inductive energy transfer.

Diese Leuchten besitzen eine Qi-Ladefunktion. Damit können Qi-kompatible Smartphones über induktive Energieübertragung kabellos geladen werden.

Ces luminaires disposent d'une fonction de chargement Qi. Cela permet aux smartphones compatibles Qi d'être chargés sans fil par transmission d'énergie inductive.



98093

LED



98247

LED

### 98093 TRUNCA

table light; plastic, white

Tischleuchte; Kunststoff, weiss

luminaire de table; plastique, blanc

H 485, Base: B 185, T 185

LED  
4W

tunable  
WHITE  
450lm



9 002759 980931



### 98247 MASSERIE

table light; plastic, white

Tischleuchte; Kunststoff, weiss

luminaire de table; plastique, blanc

H 385, Base: B 165, T 165

LED  
3,4W

neutral  
WHITE  
460lm



9 002759 982478







### 99828 ARENAZA

table light; steel, plastic, white, black  
 Tischleuchte; Stahl, Kunststoff, weiss, schwarz  
 luminaire de table; acier, plastique, blanc, noir

L 240, B 130, H 320, Base: B 240, T 120

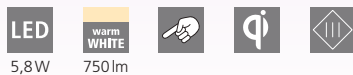

### 99829 ARENAZA

table light; steel, plastic, black  
 Tischleuchte; Stahl, Kunststoff, schwarz  
 luminaire de table; acier, plastique, noir

L 240, B 130, H 320, Base: B 240, T 120

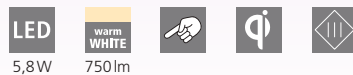



DESIGN  
HIGHLIGHT  
DETAIL

### 99831 BANDERALO

table light; plastic, white

Tischleuchte; Kunststoff, weiss

luminaire de table; plastique, blanc

L 305, B 170, H 405, Base: Ø 170

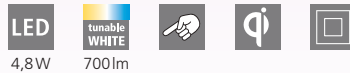

### 99832 BANDERALO

table light; plastic, black

Tischleuchte; Kunststoff, schwarz

luminaire de table; plastique, noir

L 305, B 170, H 405, Base: Ø 170

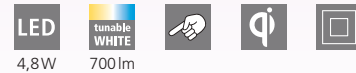



900626



900628



### 900626 LACEY-QI

table light; steel, wood, black, brown / steel, black, creme  
 Tischleuchte; Stahl, Holz, schwarz, braun / Stahl, schwarz, creme  
 luminaire de table; acier, bois, noir, marron / acier, noir, crème

L 240, B 135, H 500, Base: B 190, T 130



### 900628 VERADAL-QI

table light; steel, wood, black, brown / steel, black, creme  
 Tischleuchte; Stahl, Holz, schwarz, braun / Stahl, schwarz, creme  
 luminaire de table; acier, bois, noir, marron / acier, noir, crème

L 215, B 160, H 450, Base: Ø 160

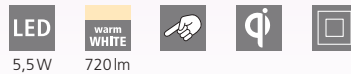



900956

LED



900958

LED



### INIESTA

The luminaire arm can be swivelled 180°.

Der Leuchtenarm ist 180° schwenkbar.

Le bras du luminaire peut pivoter de 180°.

### INIESTA

These luminaires have a USB port for charging and operating the luminaires.

Diese Leuchten verfügen über einen USB-Anschluss, der zum Laden und Betrieb der Leuchten dient.

Faites fonctionner et charger ces luminaires grâce au port USB.

### 900956 INIESTA

table light; plastic, white, black / plastic, white  
Tischleuchte; Kunststoff, weiss, schwarz / Kunststoff, weiss  
luminaire de table; plastique, blanc, noir / plastique, blanc

L 330, B 35, H 350, Base: B 160, T 115

LED 3,6W tunable WHITE 360lm ACCU Li-ion 1800mAh

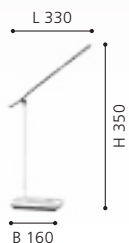

### 900958 INIESTA

table light; plastic, black / plastic, cappuccino, white  
Tischleuchte; Kunststoff, schwarz / Kunststoff, cappuccino, weiss  
luminaire de table; plastique, noir / plastique, cappuccino, blanc

L 330, B 35, H 350, Base: B 160, T 115

LED 3,6W tunable WHITE 360lm ACCU Li-ion 1800mAh



### 900957 INIESTA

table light; plastic, grey, black / plastic, white  
Tischleuchte; Kunststoff, grau, schwarz / Kunststoff, weiss  
luminaire de table; plastique, gris, noir / plastique, blanc

L 330, B 35, H 350, Base: B 160, T 115

LED 3,6W tunable WHITE 360lm ACCU Li-ion 1800mAh

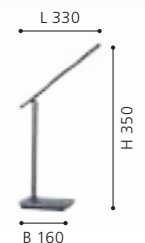



900957

LED



93901

LED

### 93901

The touch buttons can be used to dim the luminaires and adjust the light colour.

Über die Berührungsschalter kann man die Leuchten dimmen und die Lichtfarbe einstellen.

Les interrupteurs tactiles permettent de faire varier l'intensité des luminaires et de régler la couleur de la lumière.

### 93901 SELLANO

table light; plastic, steel, white, black  
Tischleuchte; Kunststoff, Stahl, weiss, schwarz  
luminaire de table; plastique, acier, blanc, noir

L 360, H 420, Base: B 180, T 180

LED

4W

tunable  
WHITE

450lm

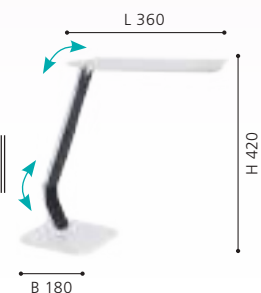



## LA SECA

These luminaires have a USB port for charging and operating the luminaires.

Diese Leuchten verfügen über einen USB-Anschluss, der zum Laden und Betrieb der Leuchten dient.

Faites fonctionner et charger ces luminaires grâce au port USB.



97044

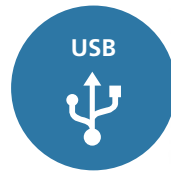

97045



### 97044 LA SECA

table light; plastic, white  
Tischleuchte; Kunststoff, weiss  
luminaire de table; plastique, blanc

L 200, B 50, H 260, Base: B 70, T 50

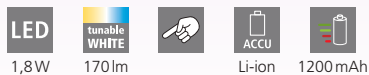

9 002759 970444

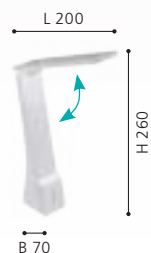

### 97045 LA SECA

table light; plastic, black  
Tischleuchte; Kunststoff, schwarz  
luminaire de table; plastique, noir

L 200, B 50, H 260, Base: B 70, T 50

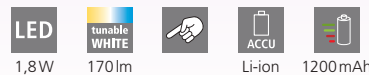

9 002759 970451



DESIGN  
HIGHLIGHT  
DETAIL



93966

LED



93965

LED

### 93966 CAUPO

table light; plastic, steel, black  
Tischleuchte; Kunststoff, Stahl, schwarz  
luminaire de table; plastique, acier, noir

L 260, H 320, Base: B 150, T 150



9 002759 939663



### 93965 CAUPO

table light; plastic, steel, white  
Tischleuchte; Kunststoff, Stahl, weiss  
luminaire de table; plastique, acier, blanc

L 260, H 320, Base: B 150, T 150



9 002759 939656

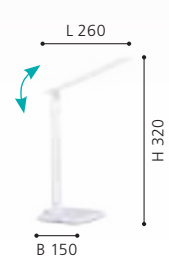





900529

LED



900528

LED

### 900529 BROLINI

table light; plastic, white  
Tischleuchte; Kunststoff, weiss  
luminaire de table; plastique, blanc

H 550, Ø 150, Base: Ø 150



2,1W



300lm



Li-ion



1500mAh



9 008606 242832



### 900528 BROLINI

table light; plastic, black  
Tischleuchte; Kunststoff, schwarz  
luminaire de table; plastique, noir

H 550, Ø 150, Base: Ø 150



2,1W



300lm



Li-ion



1500mAh



9 008606 242825





DESIGN  
HIGHLIGHT  
DETAIL



97915

LED

### 97915 COGNOLI

table light; plastic, white  
Tischleuchte; Kunststoff, weiss  
luminaire de table; plastique, blanc

L 70, B 100, H 510, Base: B 100, T 70

LED

4,4W

neutral  
WHITE

430lm



L 70



9 002759 979157

### 97914 COGNOLI

table light; plastic, black  
Tischleuchte; Kunststoff, schwarz  
luminaire de table; plastique, noir

L 70, B 100, H 510, Base: B 100, T 70

LED

4,4W

neutral  
WHITE

430lm



L 70



9 002759 979140



97914

LED



96435

LED



96434

LED



96438

LED

### 96435 LAROA

table light; plastic, white  
Tischleuchte; Kunststoff, weiss  
luminaire de table; plastique, blanc

L 480, B 120, H 325, Base: B 170, T 120

LED

neutral  
WHITE



4,2W

600lm



9 002759 964351



### 96434 LAROA

clamp light; plastic, white  
Klemmleuchte; Kunststoff, weiss  
luminaire à pince; plastique, blanc

L 450, B 65, H 275

LED

neutral  
WHITE



4,2W

600lm



9 002759 964344

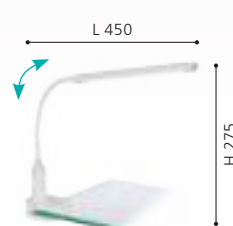

### 96438 LAROA

table light; plastic, black  
Tischleuchte; Kunststoff, schwarz  
luminaire de table; plastique, noir

L 480, B 120, H 325, Base: B 170, T 120

LED

neutral  
WHITE



4,2W

600lm



9 002759 964382





96437

LED



96439

LED



96436

LED

### 96437 LAROA

clamp light; plastic, black  
Klemmleuchte; Kunststoff, schwarz  
luminaire à pince; plastique, noir

L 450, B 65, H 275



4,2W 600lm



9 002759 964375



### 96439 LAROA

floor light; plastic, black  
Stehleuchte; Kunststoff, schwarz  
lampadaire; plastique, noir

L 535, B 215, H 1300, Base: Ø 210



4,2W 600lm



9 002759 964399

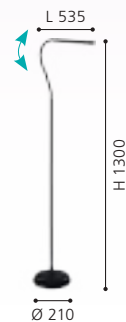

### 96436 LAROA

floor light; plastic, white  
Stehleuchte; Kunststoff, weiss  
lampadaire; plastique, blanc

L 535, B 215, H 1300, Base: Ø 210



4,2W 600lm



9 002759 964368





98831



98832

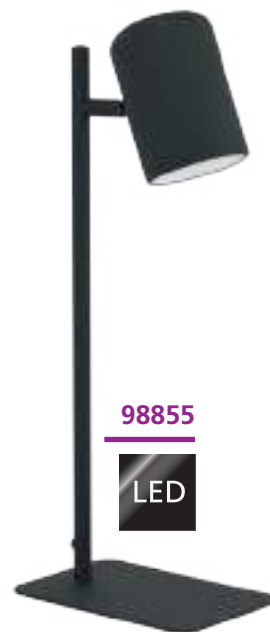

98855



### 98831 VERADAL

table light; wood, plastic, black, brown / steel, black  
Tischleuchte; Holz, Kunststoff, schwarz, braun / Stahl, schwarz  
luminaire de table; bois, plastique, noir, marron / acier, noir

B 125, H 490, Base: Ø 160



E27 1x 40W



9 002759 988319



### 98832 VERADAL

table light; wood, plastic, white, brown / steel, white  
Tischleuchte; Holz, Kunststoff, weiss, braun / Stahl, weiss  
luminaire de table; bois, plastique, blanc, marron / acier, blanc

B 125, H 490, Base: Ø 160



E27 1x 40W



9 002759 988326



### 98855 CEPPINO

table light; steel, black, white  
Tischleuchte; Stahl, schwarz, weiss  
luminaire de table; acier, noir, blanc

H 380, Base: B 165, T 110

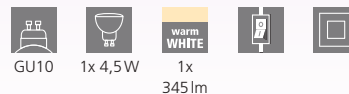

GU10 1x 4,5W 1x 345lm



9 002759 988555





98856



### 98856 CEPPINO

table light; steel, white  
Tischleuchte; Stahl, weiss  
luminaire de table; acier, blanc

H 380, Base: B 165, T 110



GU10



1x 4,5W



1x  
warm  
WHITE  
345 lm



9 002759 988562





93078

LED



94673

LED

### 93078 DURENGO

table light; plastic, steel, white, chrome  
Tischleuchte; Kunststoff, Stahl, weiss, chrom  
luminaire de table; plastique, acier, blanc, chrome

H 380, Ø 160, Base: Ø 160



2,5W 250lm



9 002759 930783

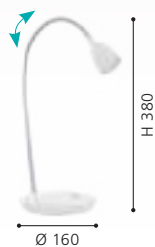

### 94673 DAMBERA

table light; plastic, black  
Tischleuchte; Kunststoff, schwarz  
luminaire de table; plastique, noir

H 375, Base: Ø 170



4,5W 660lm



9 002759 946739



### 94677 SNAPORA

table light; plastic, aluminium, black  
Tischleuchte; Kunststoff, Alu, schwarz  
luminaire de table; plastique, aluminium, noir

H 485, Base: Ø 110



3W 300lm



9 002759 946777







94677

LED



93076

LED



93077

LED



99334

LED

### 93076 GEXO

table light; plastic, steel, black, chrome  
Tischleuchte; Kunststoff, Stahl, schwarz, chrom  
luminaire de table; plastique, acier, noir, chrome

H 320, Ø 125, Base: Ø 125

LED

warm  
WHITE



2,5W

230lm



9 002759 930769

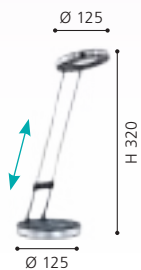

### 93077 GEXO

table light; plastic, steel, white, chrome  
Tischleuchte; Kunststoff, Stahl, weiss, chrom  
luminaire de table; plastique, acier, blanc, chrome

H 320, Ø 125, Base: Ø 125

LED

warm  
WHITE



2,5W

230lm



9 002759 930776



### 99334 CABALES

table light; plastic, white  
Tischleuchte; Kunststoff, weiss  
luminaire de table; plastique, blanc

H 340, Ø 140, Base: Ø 140

LED

warm  
WHITE



4,6W

490lm



9 002759 993344

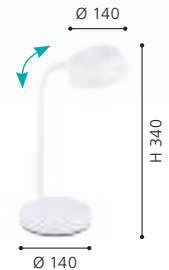



99335

LED

### 99335 CBALES

table light; plastic, black  
Tischleuchte; Kunststoff, schwarz  
luminaire de table; plastique, noir

H 340, Ø 140, Base: Ø 140



4,6W 490lm





95694

LED



97078

These luminaires have a colored light in the base.

Diese Leuchten verfügen über ein farbiges Licht im Sockel.

Ces luminaires disposent d'une lumière colorée dans le socle.

### 95694 CAJERO

table light; plastic, silver

Tischleuchte; Kunststoff, silber

luminaire de table; plastique, argent

L 150, B 100, H 500, Base: B 155, T 100

LED

4,5W

neutral  
WHITE

687lm



9 002759 956943

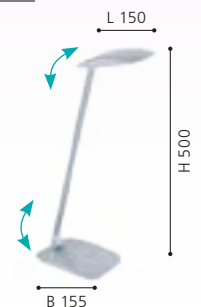



95696

LED



95695

LED



97078

LED

### 95696 CAJERO

table light; plastic, black  
Tischleuchte; Kunststoff, schwarz  
luminaire de table; plastique, noir

L 150, B 100, H 500, Base: B 155, T 100



4,5W 687lm



9 002759 956967

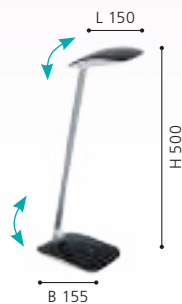

### 95695 CAJERO

table light; plastic, white  
Tischleuchte; Kunststoff, weiss  
luminaire de table; plastique, blanc

L 150, B 100, H 500, Base: B 155, T 100



4,5W 687lm



9 002759 956950

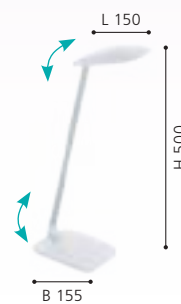

### 97078 CABADO 1

table light; plastic, white  
Tischleuchte; Kunststoff, weiss  
luminaire de table; plastique, blanc

L 140, B 110, H 490, Base: B 130, T 105



2,4W 300lm 0,3W 20lm



9 002759 970789





96957

DESIGN  
HIGHLIGHT  
DETAIL

### 96957 TORONA 1

table light; steel, white / wood, natural  
Tischleuchte; Stahl, weiss / Holz, natur  
luminaire de table; acier, blanc / bois, nature

L 445, B 180, H 605, Base: Ø 180



E14 1x 28W



9 002759 969578



### 99019 TABILLANO 1

table light; steel, black  
Tischleuchte; Stahl, schwarz  
luminaire de table; acier, noir

L 560, B 180, H 475, Base: Ø 180



E27 1x 40W



9 002759 990190





99019



**94699**



**94702**



DESIGN  
HIGHLIGHT  
DETAIL

**94699 BORGILLIO**

table light; steel, white  
Tischleuchte; Stahl, weiss  
luminaire de table; acier, blanc

L 400, B 190, H 710, Base: Ø 190



E27 1x 40W

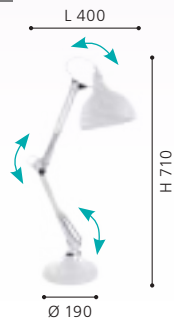

9 002759 946999

**94702 BORGILLIO**

table light; steel, chrome  
Tischleuchte; Stahl, chrom  
luminaire de table; acier, chrome

L 400, B 190, H 710, Base: Ø 190



E27 1x 40W



9 002759 947026





94697



94704

### 94697 BORGILLIO

table light; steel, black  
Tischleuchte; Stahl, schwarz  
luminaire de table; acier, noir

L 400, B 190, H 710, Base: Ø 190



E27 1x 40W



9 002759 946975

### 94704 BORGILLIO

table light; steel, copper  
Tischleuchte; Stahl, kupfer  
luminaire de table; acier, cuivre

L 400, B 190, H 710, Base: Ø 190



E27 1x 40W

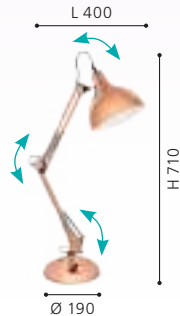

9 002759 947040



90967



DESIGN  
HIGHLIGHT  
DETAIL

### 90967 BAKER

table light; steel, brass / painted glass, green  
Tischleuchte; Stahl, messing / Glas lackiert, grün  
luminaire de table; acier, laiton / verre laqué, marron granit

L 275, H 390



E27



1x 60W



9 002759 909673



## FIRMO

These luminaires come with a clip.

Diese Leuchten sind mit einer Klemme ausgestattet.

Ces luminaires viennent avec une pince fixation.



**90872**



**90873**



**90874**

### 90872 FIRMO

table light; steel, plastic, shiny white

Tischleuchte; Stahl, Kunststoff, weiss glänzend

luminaire de table; acier, plastique, blanc brillant

L 730



E27



1x 40W



9 002759 908720

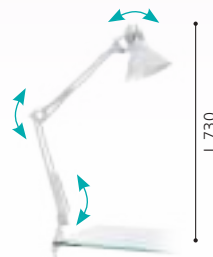

### 90873 FIRMO

table light; steel, plastic, shiny black

Tischleuchte; Stahl, Kunststoff, schwarz glänzend

luminaire de table; acier, plastique, noir brillant

L 730



E27



1x 40W



9 002759 908737



### 90874 FIRMO

table light; steel, plastic, silver

Tischleuchte; Stahl, Kunststoff, silber

luminaire de table; acier, plastique, argent

L 730



E27



1x 40W



9 002759 908744

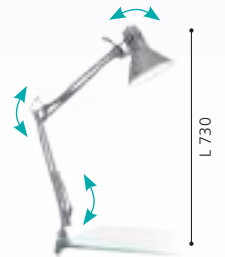



90977



9228



9229

### 90977 BASIC 1

table light; plastic, steel, silver  
Tischleuchte; Kunststoff, Stahl, silber  
luminaire de table; plastique, acier, argent

H 300, Base: Ø 125



E27 1x 40W



9 002759 909772



### 9228 BASIC

table light; plastic, steel, black  
Tischleuchte; Kunststoff, Stahl, schwarz  
luminaire de table; plastique, acier, noir

H 300, Base: Ø 125



E27 1x 40W



9 002759 922801



### 9229 BASIC

table light; plastic, steel, white  
Tischleuchte; Kunststoff, Stahl, weiss  
luminaire de table; plastique, acier, blanc

H 300, Base: Ø 125



E27 1x 40W



9 002759 922900





9230



9232

### 9230 BASIC

table light; plastic, steel, red  
Tischleuchte; Kunststoff, Stahl, rot  
luminaire de table; plastique, acier, rouge

H 300, Base: Ø 125

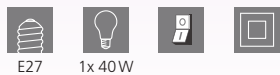

E27 1x 40W



### 9232 BASIC

table light; plastic, steel, blue  
Tischleuchte; Kunststoff, Stahl, blau  
luminaire de table; plastique, acier, bleu

H 300, Base: Ø 125

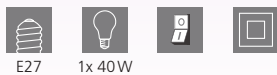

E27 1x 40W





DESIGN  
HIGHLIGHT  
DETAIL



92872

LED

**92872 FOX**

table light; steel, white, chrome  
Tischleuchte; Stahl, weiss, chrom  
luminaire de table; acier, blanc, chrome

H 320, Base: Ø 125

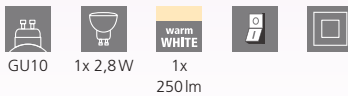

9 002759 928728



**92873 FOX**

table light; steel, anthracite, chrome  
Tischleuchte; Stahl, anthrazit, chrom  
luminaire de table; acier, gris anthracite, chrome

H 320, Base: Ø 125



9 002759 928735





92873

LED



# CHILDREN LUMINAIRES

KINDERLEUCHTEN  
LUMINAIRES POUR ENFANTS



**EN** **PLAY OF COLOUR**

The nursery luminaires are characterised by their playful and child-friendly designs. The lovely motives light up in many different colours and turn the nursery into a very special location.

**DE** **FARBENSPIEL**

Die Kinderzimmerleuchten zeichnen sich durch ihr verspieltes und kindgerechtes Design aus. Die liebevollen Motive erleuchten in unterschiedlichsten Farben und machen das Kinderzimmer zu einem besonderen Ort.

**FR** **JEU DE COULEUR**

Les éclairages de chambres d'enfants se distinguent de leur design joueur et adapté aux enfants. Les sujets formés avec amour sont illuminés dans des couleurs les plus variées et font de la chambre d'enfant un endroit spécial.







# OVERVIEW

CHILDREN LUMINAIRES  
KINDERLEUCHTEN  
LUMINAIRES POUR ENFANTS



JUNIOR 1  
866



TABARA  
867



VIKI 1  
867



This product is available in different colors and shapes. / Dieser Artikel ist in unterschiedlichen Farben und Formen verfügbar. /  
Cet article est disponible en différentes couleurs et formes.





**87284**



### 87284 JUNIOR 1

wall/ceiling light; steel, white / satin glass, football motif  
Wand- / Deckenleuchte; Stahl, weiss / Glas satiniert, Motiv Fussball  
Applique/Plafonnier; acier, blanc / verre satiné, motif football

Ø 245



E27



1x 60W



Ø 245



97667



92147



92146

### 97667 TABARA

ceiling light; wood, steel, green, white / satin glass, football motif

Deckenleuchte; Holz, Stahl, grün, weiss / Glas satiniert, Motiv Fussball

plafonnier; bois, acier, vert, blanc / verre satiné, motif football

H 80, Ø 400



E27 1x 60W

### 92146 VIKI 1

wall/ceiling light; steel, blue / satin glass, white

Wand- / Deckenleuchte; Stahl, blau / Glas satiniert, weiss

Applique/Plafonnier; acier, bleu / verre satiné, blanc

Ø 630, A 80



E27 1x 25W

### 92147 VIKI 1

wall/ceiling light; steel, pink / satin glass, white

Wand- / Deckenleuchte; Stahl, pink / Glas satiniert, weiss

Applique/Plafonnier; acier, rose / verre satiné, blanc

Ø 615, A 80



E27 1x 25W



9 002759 976675



Ø 400



9 002759 921460



Ø 630



9 002759 921477



Ø 615



# KITCHEN & FUNCTIONAL LUMINAIRES

KÜCHEN- & FUNKTIONSLEUCHTEN  
LUMINAIRES FONCTIONNELS & DE CUISINE



**EN YOUR KITCHEN FRIEND**

Our kitchen and function luminaires ensure the right lighting for your workplace and become true supporters. The practical and perfect fitted luminaires ideally refine your kitchen area.

**DE IHR KÜCHENFREUND**

Unsere Küchen- und Funktionsleuchten sorgen für die richtige Beleuchtung Ihrer Arbeitsfläche und werden zur wahren Alltagshilfe. Die praktischen Unterbauleuchten sind die perfekte Ergänzung für Ihren Küchenbereich.

**FR VOTRE AMI DE CUISINE**

Nos lumières fonctionnelles et de cuisine assurent le bon éclairage de votre surface de travail et deviennent une aide parfaite dans le quotidien. Les éclairages de meuble sont l'accompagnement parfait de votre espace de cuisine.





# OVERVIEW

KITCHEN & FUNCTIONAL LUMINAIRES  
KÜCHEN- & FUNKTIONSLEUCHTEN  
LUMINAIRES FONCTIONNELS & DE CUISINE



DUNDRY  
872-873



TEYA  
874



KOB LED  
875



This product is available in different colors and shapes. / Dieser Artikel ist in unterschiedlichen Farben und Formen verfügbar. /  
Cet article est disponible en différentes couleurs et formes.





DESIGN  
HIGHLIGHT  
DETAIL



97572

LED



97573

LED



97574

LED

### 97572 DUNDRY

wall/ceiling light; plastic, white / plastic, white  
Wand- / Deckenleuchte; Kunststoff, weiss / Kunststoff, weiss  
Applique/Plafonnier; plastique, blanc / plastique, blanc

L 570, B 25, H 35



6,6W 850lm



9 002759 975722



### 97573 DUNDRY

wall/ceiling light; plastic, white / plastic, white  
Wand- / Deckenleuchte; Kunststoff, weiss / Kunststoff, weiss  
Applique/Plafonnier; plastique, blanc / plastique, blanc

L 870, B 25, H 35



9,3W 1250lm



9 002759 975739



### 97574 DUNDRY

wall/ceiling light; plastic, white / plastic, white  
Wand- / Deckenleuchte; Kunststoff, weiss / Kunststoff, weiss  
Applique/Plafonnier; plastique, blanc / plastique, blanc

L 1170, B 25, H 35



12,8W 1700lm



9 002759 975746





97571

LED



### 97571 DUNDRY

wall/ceiling light; plastic, white / plastic, white  
Wand- / Deckenleuchte; Kunststoff, weiss / Kunststoff, weiss  
Applique/Plafonnier; plastique, blanc / plastique, blanc

L 310, B 25, H 35

LED

3,7W

neutral  
WHITE

450lm



9 002759 975715





96081



### 96081

Mounting type: inkl. mounting clips Switch type: sensor switch (on/off)

Befestigungsart: inkl. Montageclips Schalterart: Sensor Schalter (ein/aus)

Type de fixation : clips de montage inclus Type de interrupteur : interrupteur capteur (on/off)

### 96081 TEYA

under cabinet light; aluminium, silver / plastic, white  
Unterbauleuchte; Alu, silber / Kunststoff, weiss  
éclairage de meuble; aluminium, argent / plastique, blanc

L 600, B 55, H 25



10W



950lm



9 002759 960810

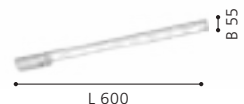



93707



93706



**93707 KOB LED**

under cabinet light; steel, satin nickel  
 Unterbauleuchte; Stahl, nickel-matt  
 éclairage de meuble; acier, nickel mat

L 600, B 70, H 25



**93706 KOB LED**

under cabinet light; steel, white  
 Unterbauleuchte; Stahl, weiss  
 éclairage de meuble; acier, blanc

L 600, B 70, H 25



9 002759 937072

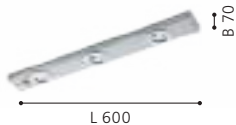

9 002759 937065





# ACCESSORIES

ZUBEHÖR  
ACCESSOIRES



**EN MAKING IT SPECIAL**

Supplement your personal luminaire range with practical accessories and make your everyday life easier.

**DE DAS GEWISSE EXTRA**

Ergänzen Sie Ihr persönliches Leuchtensortiment mit praktischem Zubehör und erleichtern Sie sich somit Ihren Alltag.

**FR LE PETIT PLUS QUI COMPTE**

Accompagnez votre collection personnelle de lumières par des accessoires pratiques et facilitez-vous ainsi votre quotidien.





# OVERVIEW

ACCESSORIES  
ZUBEHÖR  
ACCESSOIRES



EXTENTION  
**881**



ELEKTR.TRAFO  
**882**



RUEDA  
**882**



This product is available in different colors and shapes. / Dieser Artikel ist in unterschiedlichen Farben und Formen verfügbar. /  
Cet article est disponible en différentes couleurs et formes.









**92288**

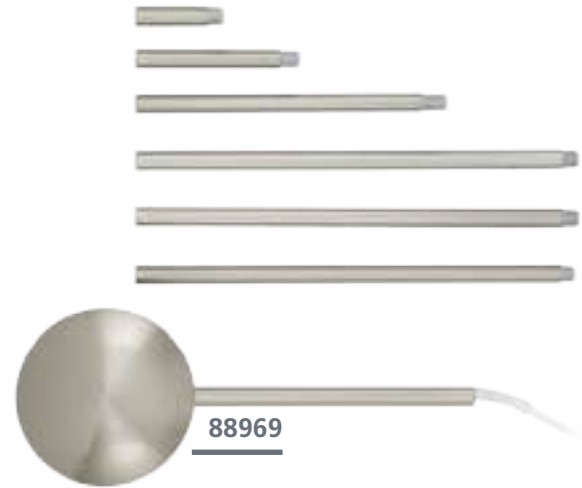

**88969**

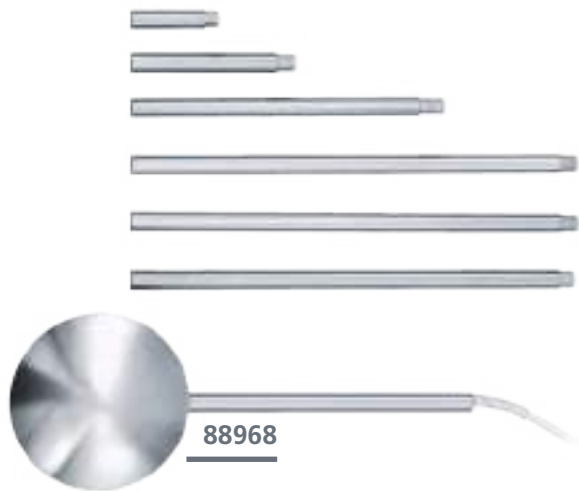

**88968**



### EXTENTION

Can be extended or shortened from 320 to 1570 mm by screwing in/off the single pieces.

Der Kabelkanal kann durch Ein-/Ausdrehen der Einzelstücke von 320 bis 1570 mm verlängert bzw. verkürzt werden.

Le conduit de câble peut être prolongé ou raccourci en visse/dévisse les pièces uniques de 320 à 1570 mm.

### 92288 EXTENTION

accessory; steel, white  
Zubehör; Stahl, weiss  
Accessoires; acier, blanc

L 1570, B 120

### 88969 EXTENTION

accessory; steel, satin nickel  
Zubehör; Stahl, nickel-matt  
Accessoires; acier, nickel mat

L 1570, B 120

### 88968 EXTENTION

accessory; steel, chrome  
Zubehör; Stahl, chrom  
Accessoires; acier, chrome

L 1570, B 120





+



=



### RUEDA

Convert your single-flame luminaires into a three-flame light source for brighter illumination.

Verwandeln Sie Ihre einflammigen Leuchten in eine dreiflammige Lichtquelle für hellere Beleuchtung.

Transforme vos luminaires à une flamme en une source lumineuse à trois flammes pour un éclairage plus lumineux.



92348



98277



98279

### 92348 ELEKTR.TRAFO

accessory; plastic, white  
Zubehör; Kunststoff, weiss  
Accessoires; plastique, blanc

L 113, B 44, H 28



10



9 002759 923488



### 98277 RUEDA

accessory; plastic, white  
Zubehör; Kunststoff, weiss  
Accessoires; plastique, blanc

H 75, Ø 190



E27

3x 20W



9 002759 982775



### 98279 RUEDA

accessory; plastic, black  
Zubehör; Kunststoff, schwarz  
Accessoires; plastique, noir

H 75, Ø 190



E27

3x 20W



9 002759 982799





1



2

98277





# INDEX & LEGEND

INDEX & ERKLÄRUNG  
INDEX & LÉGENDE



**EN** **INDEX & LEGEND**

On the following pages you will get an insight into EGLO Worldwide, explanations of product pages and pictograms and an overview of the entire catalogue by means of indexes. Afterwards, you will also find space for your personal notes.

**DE** **INDEX & ERKLÄRUNG**

Auf den folgenden Seiten erhalten Sie einen Einblick in EGLO Weltweit, Erklärungen von Produktseiten und Piktogrammen und einen Überblick über den gesamten Katalog mittels Register. Anschließend finden Sie auch platz für Ihre persönlichen Notizen.

**FR** **INDEX & LÉGENDE**

Les pages suivantes vous donneront un aperçu d'EGLO Worldwide, des explications sur les pages de produits et les pictogrammes, ainsi qu'une vue d'ensemble du catalogue au moyen d'index. Ensuite, vous trouverez également de la place pour vos notes personnelles.

# GLASS MATERIALS

GLAS-MATERIALIEN

MATÉRIAUX DEW VERRE



glass alabaster, white  
Glas alabaster, weiß  
verre albâtre, blanc

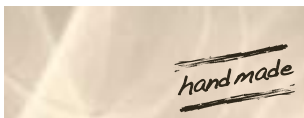

glass alabaster, champagne  
Glas alabaster, champagner  
verre albâtre, champagne



coating, black  
Beschichtung, schwarz  
revêtement, noir



glass wipe technique, champagner  
Glas Wischtechnik, champagner  
verre technique à l'essuyés, champagner

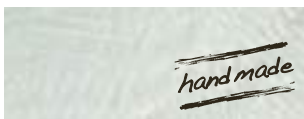

limed glass  
Glas gekalkt  
verre chaulé



brilliant glass  
Brillantglas  
verre brillant



structured glass  
Glas mit Struktur  
verre structuré blanc



molten splinters of glass/ brilliant glass (granille)  
geschmolzene Splitter von Glas / Brillantglas (granille)  
éclats fondus de verre / verre brillant (granille)



structured glass, white printed decor  
strukturiertes Glas, weiß gedrucktes Dekor  
verre structuré, décor imprimé blanc

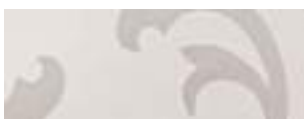

printed glass with decor  
bedrucktes Glas mit Dekor  
verre imprimé avec la décoration



glass painted, green  
Glas lackiert, grün  
verre laqué, vert



smoked glass, black-transparent  
Rauchglas, schwarz-transparent  
verre fumé, noir transparent

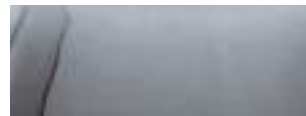

glass vaporized, black-transparent  
Glas bedampft, schwarz-transparent  
verre vaporisé, noir transparent



glass vaporized, amber  
Glas bedampft, amber  
verre vaporisé, ambre



gold-color  
goldfarben  
or



black-brown-transparent  
schwarz-braun-transparent  
noir-marron-transparent



black-grey-transparent  
schwarz-grau-transparent  
noir-gris-transparent



glass opal-matt  
glas opal-matt  
verre opale-mat



grey-matt  
grau-matt  
gris mat



sandy  
sandfarben  
couleur sable

# EGLO WORLDWIDE SALES COMPANIES

EGLO WELTWEIT VERTRIEBSGESELLSCHAFTEN

EGLO DANS LE MONDE SOCIÉTÉS DE VENTE



**AUSTRIA**  
EGLO LEUCHTEN GMBH

Heiligkreuz 22  
6136 Pill  
T: +43 5242 6996 110 | F: +43 5242 6996 972  
info-austria@eglo.com



**CHILE**  
EGLO CHILE ILUMINACIÓN LTDA.

Av. Américo Vespucio Norte 1930  
Conchali - Santiago de Chile  
T: +562 2 595 2222  
info-chile@eglo.com



**DENMARK**  
EGLO DANMARK A/S

Agerbakken 20  
8362 Hørning  
T: +45 70 22 55 11  
info-denmark@eglo.com



**AUSTRALIA**  
EGLO LIGHTING AUSTRALIA

5/339 Archerfield Road  
4077 Richlands | Queensland  
T: +61 7 3375 1413 | F: +61 7 3375 1412  
info@eglolighting.com.au



**CHINA**  
DONGGUAN EGLO LIGHTING  
COMMERCIAL CO LTD

No.1 | Shangqiao Industrial Rd Shangqiao, Dongcheng  
Dongguancity, Guanzhouprovince  
T: +86 769 2203 3866 | F: +86 769 2203 6866  
info-china@eglo.com



**ESTONIA**  
MOODNE VALGUSTUS AS

Rävala pst. 7  
10143 Tallinn  
T: +372 667 6670 | F: +372 631 3195  
info-estonia@eglo.com



**BELGIUM**  
EGLO BELGIUM BV

Antwerpsesteenweg 247  
2950 Kapellen  
T: +32 3 250 60 80 | F: +32 3 219 80 67  
info-belgium@eglo.com



**COLOMBIA**  
EGLO COLOMBIA ILUMINACIÓN SAS

Autopista Norte 800 Mts adelante del Peaje de los Andes  
Costado Oriental Km 19 Lote 30  
Bogotá - Chia  
T: +57 (1) 744 2339  
info-colombia@eglo.com



**FINLAND**  
EGLO FINLAND OY

Malmi raitti 17A  
00700 Helsinki  
T: +358 20 7649 820  
info-finland@eglo.com



**BOSNIA AND HERZEGOVINA**  
EGLO RASVJETA BH D.O.O.

Hrgovi Donji 178  
76250 Gradacac  
T: +387 35 86 85 00 | F: +387 35 82 44 41  
info-Bosnia-Herzegovina@eglo.com | info@eglo.ba



**COSTA RICA**  
EGLO COSTA RICA

Centro Comercial Calle Real local #8 de la sucursal del  
BAC San José 800 metros al norte Guachipilín de Escazú  
San José, Costa Rica  
T: +506-2289-4690 | F: +506-2100-6384  
info-costarica@eglo.com



**FRANCE**  
EGLO FRANCE LUMINAIRE SARL

Z.A. Jeune Bois | 2 Rue de la Martinique  
68274 Wittenheim  
T: +33 3 89 62 50 45 | F: +33 389 6250 49  
info-france@eglo.com



**BULGARIA**  
EGLO BULGARIA EOOD

Main Road Burgas-Sofia | 5th kilometer | Building EGLO  
8000 Burgas  
T: +359 888 755 509  
info-bulgaria@eglo.com



**CROATIA**  
EGLO RASVJETA D.O.O.

Jadranska avenija 9  
10020 Zagreb  
T: +385 1 379 40 62 | F: +385 1 379 41 04  
info-croatia@eglo.com



**GERMANY**  
EGLO LEUCHTEN HANDELS GMBH

Kleinbahnstr. 35  
59759 Arnsberg  
T: +49 2932 6269 0 | F: +49 2932 6269 39  
info-germany@eglo.com



**CANADA**  
EGLO CANADA INC.

20700 Route Transcanadienne  
H9X 4B7 Baie D'Ufré, Quebec  
T: +1 514 457 5483 | F: +1 514 457 5487  
info-canada@eglo.com



**CZECH REPUBLIC**  
EGLO CZ+SK s.r.o.

Náchodská 2479/63  
193 00 Praha 9  
T: +420 281 924 163 | F: +420 281 925 205  
info-czechrepublic@eglo.com



**GREAT BRITAIN AND IRELAND**  
EGLO UK LTD.

Unit 12 Cirrus Park, Lower Farm Road, Moulton Park  
Industrial Estate, Northampton NN3 6UR  
T: +44 1604 790 986  
info-UK@eglo.com



**GREECE**  
EGLO HELLAS A.E.

Sykias 2 and parodos dekeleias  
13679 Acharnai  
T: +30 21 0800 2363  
info-greece@eglo.com

**HUNGARY**  
EGLO LUX KFT.

Fő út 143/A  
2120 Dunakeszi  
T: +36 27 341 353  
info-hungary@eglo.com

**INDIA**  
EGLO INDIA PRIVATE LIMITED

A-307, Ansal Chambers - 1, 3, Bhikaji Cama Place,  
110066 Delhi  
T: +91 85279 44288  
info-india@eglo.com

**ITALY**  
EGLO ITALIANA S.R.L.

Via Giotto, 4  
31021 Mogliano Veneto (TV)  
T: +39 041 45 66 245 | F: +39 041 45 74 066 / 071  
info-italy@eglo.com

**KAZAKHSTAN**  
EGLO KAZAKHSTAN LLP

Al-Farabi Avenue 7, Office 72, 14rd floor, Block 4A,  
Nurly-Tau Business Center  
50059 Almaty  
T: +7 727 293 25 20 | M: +7 701 031 00 00  
info-kazakhstan@eglo.com

**KOSOVO**  
EGLO KOSOVA LLC

Lugisht e qytetit pn  
20000 Prizren  
T: +383 44 216 687 | SHOP: +383 49 699 100  
info-kosovo@eglo.com

**LATVIA**  
MOODNE VALGUSTUS AS

Rävala pst.7  
10143 Tallinn  
T: +370 652 49923 | T: +372 667 6670  
info-latvia@eglo.com

**LITHUANIA**  
MOODNE VALGUSTUS AS

Rävala pst.7  
10143 Tallinn  
T: +370 652 49923 | T: +372 667 6670  
info-lithuania@eglo.com

**MALAYSIA**  
EGLO ASIA SDN BHD

B-07-13, Empire Soho, Empire Subang, Jalan SS 16/1,  
47500 Subang Jaya, Selangor Darul Ehsan.  
T: +60162115313  
info-malaysia@eglo.com

**MEXICO**  
EGLO MÉXICO ILUMINACIÓN S DE RL DE CV

Prolongación Avenida López Mateos Sur N°3561,  
Fraccionamiento Los Gavilanes  
C.P. 45645 Tlajomulco de Zúñiga | Jalisco  
T: +52 33 3687 20 95  
info-mexico@eglo.com

**MIDDLE EAST**  
EGLO LIGHTING MIDDLE EAST FZE

P.O. BOX 262073, LOB6, OFFICE G18  
Jebel Ali, Dubai, UAE  
T: +97 148810080 | F: +97 148810081  
gulf@eglo.com

**MOROCCO - EGLO AFRICA**  
EGLO MAGHREB LUMINAIRES SARL

219 Bd Med Zerktoouni. Suite: 67  
20330 Casablanca  
T: +212 522 98 80 25 / -05  
info-global@eglo.com | info.africa@eglo.com

**THE NETHERLANDS**  
EGLO VERLICHTING NEDERLAND B.V.

Innovatiepark 20  
4906 AA Oosterhout (NB)  
T: +31 162 48 28 30  
info-nl@eglo.com

**NORWAY**  
MS BELYSNING

Gardermovegen 95B  
2030 Nannestad  
T: +47 63 888500 | F: +47 63 888501  
info-norway@eglo.com

**PERU**  
EGLO PERU S.A.C

Av Primavera 1419  
Distrito de Santiago de Surco y Departamento de Lima  
T: +51 902 763 635  
info-peru@eglo.com

**POLAND**  
EGLO POLSKA SP. Z O.O.

Ul. Dźwiękowa 2  
02-857 Warszawa  
T: +48 22 644 57 55 | F: +48 22 644 89 82  
info-poland@eglo.com

**PORTUGAL**  
EGLO PORTUGAL ILUMINAÇÃO, LDA

Rua Fonte Parada, 125  
4595-434 Seroa-Paços de Ferreira  
T: +351 255 890 000  
info-portugal@eglo.com

**ROMANIA**  
EGLO ROMANIA PRODEXIM SRL.

Str. Atomistilor nr. 1D  
77125 Magurele - Ilfov  
T: +40 314 250 902 | F: +40 314 250 899  
info-romania@eglo.com

**RUSSIA**  
EGLO LIGHTING LLC

Varshavskoe shosse 3 | Office 23  
117105 Moscow  
T: +7495 789 4311 | F: +7495 789 4312  
info-russia@eglo.com

**SERBIA**  
EGLO RASVETA DOO

Stefana Prvovenčanog 28  
11000 Beograd  
T: +381 11 3981 366 | F: +381 11 3981 389  
info-serbia@eglo.com

**SLOVAKIA**  
EGLO CZ+SK s.r.o

Náchodská 2479/63  
193 00 Praha 9  
T: +421 313 211 551 | F: +421 313 211 556  
info-slovakia@eglo.com

**SLOVENIA**  
EGLO RASVJETA D.O.O.

Jadranska avenija 9  
10020 Zagreb  
T: +386 158 093 18  
info-slovenia@eglo.com

**SPAIN**  
EGLO ESPAÑA ILUMINACIÓN S.L.

Avda. de Castilla,1 (Edf. Best Point) 2º Planta - Oficina  
16A-B  
28830 San Fernando de Henares, Madrid  
T: +34 91 677 90 44 | F: +34 91 677 03 04  
info-spain@eglo.com

**SWEDEN**  
EGLO SVERIGE AB

Star Street 1  
512 50 Svenljunga  
T: +46 340 623 505  
info-sweden@eglo.com

**SWITZERLAND**  
EGLO SCHWEIZ AG

Seetalstrasse 142  
6032 Emmen  
T: +41 41 268 69 59  
info-switzerland@eglo.com

**TURKEY**  
EGLO Aydınlatma ithalat ihracat Ltd. Şti.

Eyüp Sultan Mah. Sekmen Cad. No:18/2  
34885 Sancaktepe / Istanbul Samandıra  
T: +90 216 311 09 -02 / -03 / -04 |  
F: +90 216 311 09 / -05  
info-turkey@eglo.com

**UKRAINE**  
EGLO UKRAINE LTD

Vatslava Gavela boulevard, 6/7-A,  
03124 Kyiv  
T: +38 067 670 58 61  
info-ukraina@eglo.com

**USA**  
EGLO USA, INC.

3640 Royal South Parkway  
30349 Atlanta, Georgia  
T: +1 404 477 5601 | F: +1 404 393 7053  
info-usa@eglo.com

# HOW TO READ

ERKLÄRUNG

COMMENT LIRE

ARTICLE NUMBER & SERIES NAME  
ARTIKELNUMMER & SERIENNAME  
NUMÉRO D'ARTICLE & NOM DE LA SÉRIE

DESCRIPTION  
BESCHREIBUNG  
DESCRIPTION

The product description is composed as follows:  
luminaire type; enclosure material, enclosure colour /  
glass or shade material, glass or shade colour  
Die Produktbeschreibung setzt sich wie folgt zusammen:  
Leuchtenart; Gehäusematerial, Gehäusefarbe / Schirm-  
bzw. Glasmaterial, Schirm- bzw. Glasfarbe  
La description du produit est composée comme suit:  
type de luminaire; matériel de boîtier, couleur de boîtier /  
matériel de verre ou abat-jour, couleur de verre ou abat-jour

DIMENSIONS  
DIMENSIONEN  
DIMENSIONS

all dimensions in mm | alle Größen in mm | toutes dimensions en mm

L = length | Länge | longueur

B = width | Breite | largeur

H = height | Höhe | hauteur

∅ = diameter | Durchmesser | diamètre

A = projection length | Ausladung | amplitude

ET = installation depth | Einbautiefe | profondeur utile

Base = base dimensions | Sockelmaße | dimensions de base

Attention! The dimensions relate solely to the sizes of the luminaire.  
Any air spaces that would be relevant for a safe operating of the  
lamp were not considered.

Achtung! Die Größen beziehen sich nur auf die Abmessungen der  
Leuchte. Etwaige Lufträume, die für einen sicheren Betrieb der  
Leuchte notwendig sind, werden nicht berücksichtigt.

Attention! Les dimensions se réfèrent à la taille de la lampe seule-  
ment. Espacements éventuels, que seraient importants pour une  
opération de la lampe sans danger, n'ont pas été considérés.

SKETCHES  
SKIZZEN  
CROQUIS

The sketches state the most meaningful dimensions. If a product  
is adjustable by will, a turquoise arrow marks this function and  
only the maximum dimensions are indicated.

Die Bemaßung der Skizzen umfasst jeweils die aussagekräftig-  
sten Größen. Bei verstellbaren Produkten kennzeichnet ein  
türkiser Pfeil diese Funktion und nur die maximalen Größen  
werden angegeben.

Les dimensions des croquis comprennent les plus représenta-  
tives. Si un produit est réglable au choix, une flèche turquoise  
affiche cette fonction et rien que les dimensions maximales  
sont indiquées.

**99795 LIBERTAD**  
pendant light; steel, wood, black, brown  
Hängeleuchte; Stahl, Holz, schwarz, braun  
luminaire en suspension; acier, bois, noir, marron

L 180, B 180, H 1100

E27 1x 40W

**99855 LIBERTAD**  
pendant light; steel, wood, black, brown  
Hängeleuchte; Stahl, Holz, schwarz, braun  
luminaire en suspension; acier, bois, noir, marron

L 880, B 180, H 1100

E27 3x 40W

**99856 LIBERTAD**  
ceiling light; steel, wood, black, brown  
Deckenleuchte; Stahl, Holz, schwarz, braun  
plafonnier; acier, bois, noir, marron

L 860, B 180, H 240

E27 3x 40W

L 180 H 1100

L 880 H 1100

L 860 H 240

LIGHTING FAMILIES / STANDARD  
**234**



PRODUCT / PRODUCT IN THE AMBIANCE  
 PRODUKT / PRODUKTE IM AMBIENTE  
 PRODUITS / PRODUITS DANS L'AMBIENCE

You can find the article number next to each product on the page and in the ambiance pictures.

Sie finden die Artikelnummer jedes Produktes neben der Abbildung auf der Seite und auf unseren Ambientebildern.

Vous pouvez trouver le numéro d'article à la page et à côté de chaque produit dans les images de l'ambiance.

CERTIFICATE  
 ZERTIFIKAT  
 CERTIFICAT



Information on FSC® - certified products can be found on page 8.

Informationen über FSC® -zertifizierte Produkte finden Sie auf Seite 8.

Vous trouverez des informations sur les produits certifiés FSC® à la page 8.

PICTOGRAMMES  
 PIKTOGRAMME  
 PICTOGRAMMES

Technical details are represented as pictograms. An overview over all pictograms can be found on the next pages.

Technische Details werden als Piktogramme dargestellt. Eine Übersicht über alle Piktogramme finden Sie auf den nächsten Seiten.

Les détails techniques sont représentés sous forme de pictogrammes. Vous trouverez un aperçu de tous les pictogrammes dans les pages suivantes.

BUTTONS  
 BUTTONS  
 BOUTONS

**CRI >90** Colour Rendering Index | Farbwiedergabeindex | Indice de rendu de couleur de LED

**INCL.** Bulb included | Leuchtmittel inkludiert | ampoules inclus

**RECESSED** Recessed Luminaire | Einbauleuchte | luminaire encastrable

**SURFACE** Surface Luminaire | Aufbauleuchte | luminaire en saillie

**900349 LIBERTAD 1**

pendant light; steel, wood, black, brown  
 Hängeleuchte; Stahl, Holz, schwarz, braun  
 luminaire en suspension; acier, bois, noir, marron

L 760, B 140, H 1100

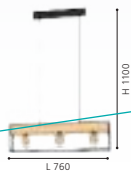

**900349**

The flower pots are included with this luminaire.

Bei dieser Leuchte sind die Blumentöpfe inkludiert.

Les pots de fleurs sont inclus avec ce luminaire.

LIGHTING FAMILIES / STANDARD  
**235**

# HOW TO READ / ILLUMINANTS

ERKLÄRUNG / LEUCHTMITTEL

COMMENT LIRE / AMPOULES



















1

PICTOGRAMMES  
PIKTOGRAMME  
PICTOGRAMMES

Technical details are represented as pictogrammes.

Technische Details werden als Piktogramme dargestellt.

Les détails techniques sont représentés sous forme de pictogrammes.

	Lumen Lumen Lumen		Not dimmable Nicht dimmbar Pas de gradation		Colour rendering index Farbwiedergabeindex L'indice de restitution de couleurs
	Not suitable as main light source Nicht als Hauptleuchtmittel geeignet Ne convient pas comme source lumineuse principale		Step dimmable Stufen dimmbar gradation par étapes		Beamangle Ausstrahlwinkel Angle de rayonnement
	Dimensions in mm Abmessungen in mm Dimensions en mm		Control unit Stufen dimmbar unité de contrôle		Day/night-sensor Tag/Nacht-Sensor Capteur jour/nuit
	Wattage Wattage Puissance		Lifetime Steuereinheit Durée de vie		Motion-sensor Bewegungsmelder Détecteur de mouvement
	Operating voltage Betriebsspannung Tension de fonctionnement		Selling Unit Verpackungseinheit Unité d'emballage		Motion-sensor & day/night-sensor Bewegungsmelder & Tag/Nacht-Sensor Détecteur de mouvement et détecteur jour/nuit
	Socket Socket Douille		Comparative value of brightness to conventional light bulbs Vergleichswert der Helligkeit zu konventionellen Glühlampen Valeur comparative de la luminosité par rapport aux ampoules à incandescence conventionnelles		incl. battery inkl. Batterie incl. pile
	Dimmable Dimmbar Dimmable				



DIMMABLE  
VIA REMOTE  
AND APP

1
2
3

## 12251 GU10-LED











**345 lm**



**2700-6500 K**



 L 59, Ø 50	 dimmable via remote & app	 45°
 4.9 W	 15000 h	
 220-240V, 50/60Hz	 4.9 W ~ 50 W	
 GU10	 83 CRI	



9 002759 122515













## 2

### LIGHT COLOUR & KELVIN LICHTFARBE & KELVIN COULEUR LUMINEUX & KELVIN

The colours of the LED are represented as pictogrammes (see below), their luminous flux directly beneath. The luminous flux is quoted in lumen and describes the amount of light generated by the LED. The higher the value, the brighter is the lamp. Lumens are LED boards and are the light measurement value in bulbs.

Die Farben der LED werden als Piktogramm (siehe unten) dargestellt, deren Lichtstrom direkt darunter. Der Lichtstrom wird in Lumen gemessen und gibt die erzeugte Lichtmenge der LED an. Je höher der Wert, desto heller das Produkt. Lichtstromangaben (Lumen) sind Platinen- bzw. Leuchtmittelwerte.

Les couleurs de DEL ont représentés sous forme de pictogrammes, leur flux lumineux directement en dessous. L'unité de flux lumineux est le lumen et il mesure la quantité de lumière générée par les DEL. Plus la valeur est élevée, plus la lampe est lumineuse. Les lumens sont l'unité de mesure de l'intensité lumineuse des ampoules et des panneaux led intégrés.

 <b>RGB</b>	RGB RGB RGB	 <b>RGB+NW</b>	RGB + neutralwhite RGB + neutralweiß RGB + blanc neutral	 <b>cold WHITE</b>	cold white kaltweiß blanc froid
 <b>RGB+W</b>	RGB + white RGB + weiß RGB + blanc	 <b>RGB+TW</b>	RGB + tunable white RGB + tunable white RGB + tunable white	 <b>neutral WHITE</b>	neutral white neutralweiß blanc neutre
 <b>RGB+WW</b>	RGB + warmwhite RGB + warmweiß RGB + blanc chaud	 <b>tunable WHITE</b>	tunable white tunable white tunable white	 <b>YELLOW</b>	Yellow Gelb Jaune
 <b>RGB+CW</b>	RGB + coldwhite RGB + kaltweiß RGB + blanc froid	 <b>warm WHITE</b>	warm white warmweiß blanc chaud	 <b>RED</b>	Red Rot rouge

## 3

### ENERGY EFFICIENCY LABELS ENERGIEEFFIZIENZ-LABEL LABEL DE L'EFFICACITÉ ÉNERGÉTIQUE

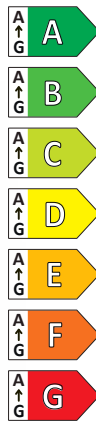
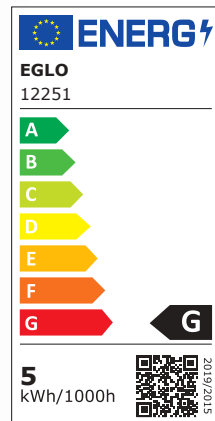

The new energy label must be indicated on all light sources with a luminous flux between 60 and 82,000 lumens and LED. This applies to lamps, LED modules and luminaires where the light source cannot be removed without destroying it. The energy spectrum ranges from A to G.

Das neue Energielabel muss auf allen Lichtquellen mit einem Lichtstrom zwischen 60 und 82.000 Lumen und LED angegeben werden. Dies gilt für Lampen, LED-Module und Leuchten, bei denen die Lichtquelle nicht zerstörungsfrei entnommen werden kann. Das Energiespektrum reicht von A bis G.

Le nouveau label énergétique doit être indiqué sur toutes les sources lumineuses dont le flux lumineux est compris entre 60 et 82 000 lumens et sur les LED. Cela s'applique aux lampes, aux modules LED et aux luminaires dont la source lumineuse ne peut être retirée sans être détruite. Le spectre énergétique va de A à G.

The information on the label includes: /  
Die Angaben auf dem Etikett beinhalten: /

Les informations figurant sur l'étiquette sont les suivantes :



















- › Name/Trademark / Name/Warenzeichen / Nom/marque de commerce
- › Model / Modell / Modèle
- › Energy label scale A-G / Energielabel-Skala A-G / Échelle d'étiquetage énergétique A-G
- › Energy consumption for 1,000 hours of use / Energieverbrauch bei 1.000 Stunden Nutzung / Consommation d'énergie pour 1 000 heures d'utilisation
- › Energy efficiency class of the product / Energieeffizienzklasse des Produkts / Classe d'efficacité énergétique du produit
- › QR Code to EPREL (Product Database of the European Product Registry for Energylabelling) / QR Code zur EPREL (Produktdatenbank der European Product Registry for Energylabelling) / Code QR pour EPREL (base de données des produits du registre européen des produits pour l'étiquetage énergétique)

# PICTOGRAM











PIKTOGRAMME

PICTOGRAMME

## SOCKETS / FASSUNGEN / DOUILLES

 LED	 G4	 G53
 2G7	 G5	 GU5,3 / MR16
 2G11	 G9	 GU10
 2GX13	 G10Q	 GX53
 E14	 G13	 GY6,35
 E27	 G23	 R7s

## BULBS / LEUCHTMITTEL / AMPOULES

 E14 / C35	 E27 / A60 Halogen	 E27 / E140 Filament
 E14 / C35f	 E27 / R63 Halogen	 E27 / PS160 Filament
 E14 / D45	 E27 / A60 LED	 E27 / T30 Filament
 E14 / C35f LED	 E27 / A60 Filament	 E27 / T32 Filament
 E14 / D45 Halogen	 E27 / A65 LED	 G4 / T9
 E14 / C35 Halogen	 E27 / A75 Filament	 G4 / LT9
 E14 / T22	 E27 / G45 LED	 G4 / LT14
 E14 / C35 Filament	 E27 / G45 Filament	 G9
 E14 / C37 Filament	 E27 / G80 Filament	 G9 LED
 E14 / C35f Filament	 E27 / G95	 GU10
 E14 / C37f Filament	 E27 / G95 Filament	 GU10 LED
 E14 / P45 LED	 E27 / G125	 GU10 SMD LED
 E14 / P45 Filament	 E27 / G95 LED	 GX53 / LF75
 E14 / P50	 E27 / G200 Filament	<b>LED</b> LED board / LED Platine / LED bord
 E14 / ST48 Filament	 E27 / R63 LED	 MR16
 E14 / ST64 Filament	 E27 / ST48 Filament	 MR16 LED
 E14 / T20 LED	 E27 / ST64 Filament	 R7s / 78mm
 E27 / A60	 E27 / B80 Filament	 R7s / 118mm
 E27 / G90	 E27 / BR150 Filament	 R7s / 78mm LED
 E27 / QR63	 E27 / DP165 Filament	 R7s / 118mm LED

### LIGHT COLOUR & LUMEN / LICHTFARBE & LUMEN / COULEUR LUMINEUX & LUMEN

The colours of the LED are represented as pictogrammes (see below), their luminous flux directly beneath. The luminous flux is quoted in lumen and describes the amount of light generated by the LED. The higher the value, the brighter is the lamp. Lumens are LED boards and are the light measurement value in bulbs.

Die Farben der LED werden als Piktogramm (siehe unten) dargestellt, deren Lichtstrom direkt darunter. Der Lichtstrom wird in Lumen gemessen und gibt die erzeugte Lichtmenge der LED an. Je höher der Wert, desto heller das Produkt. Lichtstromangaben (Lumen) sind Platinen- bzw. Leuchtmittelwerte.

Les couleurs de LED ont représentés sous forme de pictogrammes, leur flux lumineux directement en dessous. L'unité de flux lumineux est le lumen et il mesure la quantité de lumière générée par les LED. Plus la valeur est élevée, plus la lampe est lumineuse. Les lumens sont l'unité de mesure de l'intensité lumineuse des ampoules et des panneaux led intégrés.

	RGB RGB RGB
	RGB + white RGB + weiß RGB + blanc
	RGB + warmwhite RGB + warmweiß RGB + blanc chaud
	RGB + coldwhite RGB + kaltweiß RGB + blanc froid

	RGB + neutralwhite RGB + neutralweiß RGB + blanc neutral
	RGB + tunable white RGB + tunable white RGB + tunable white
	tunable white tunable white tunable white
	warm white warmweiß blanc chaud

	cold white kaltweiß blanc froid
	neutral white neutralweiß blanc neutre

### SWITCHES & SENSORES / SCHALTER & SENSOREN / INTERRUPTEUR & CAPTEURS

	incl. cable & plug inkl. Kabel & Stecker câble & connecteur inclus
	internal dimmer eingebauter Dimmer variateur intégré
	button switch Druckknopf interrupteur de pression
	function switch Funktionsschalter interrupteur fonction
	rocker switch Wippschalter interrupteur à bascule
	pedal dimmer Trittdimmer variateur à pied

	pedal switch Trittschalter interrupteur à pied
	cable switch Kabelschalter interrupteur à câble
	incl. cable & plug transformer inkl. Kabel & Stecktransformator câble & transformateur à prise
	remote control Fernbedienung télécommande
	Day & Night Sensor Tag & Nacht Sensor sensor jour & nuit
	sensor Sensor sensor

	swedish plug Stecker Schweden connecteur swede
	"Touch me" ON/OFF "Touch me" EIN/AUS "Touch me" ON/OFF
	"Touch me" ON/OFF & dimm "Touch me" EIN/AUS & Dimmen "Touch me" ON/OFF & graduable
	pull switch Zugschalter interrupteur à bascule
	Timer - automatic on/off Zeitschaltuhr - automatisches Ein- & Ausschalten minuterie - peut être éteint et allumé automatiquement

### FUNKTIONS & COMFORT / FUNKTIONEN & KOMFORT / FONCTIONS & CONFORT

	incl. battery inkl. Akku incl. pile
	incl. battery inkl. Batterie incl. pile
	battery specifications Batteriespezifikationen spécifications des piles
	beam angle Ausstrahlwinkel angle de rayonnement
	corner mount possible Eckmontage möglich montage en coin possible
	Colour Rendering Index

	cutout (in mm) Ausschnitt (in mm) perçage du panneau (en mm)
	dimmmable with external dimmer dimmmbar mit externen Dimmer graduable avec un gradateur externe
	not dimmmable nicht dimmmbar ne pas graduable
	Can be operated via control unit Bedienbar über Steuergerät Peut être commandé par une unité de contrôle
	replaceable LED austauschbare LED LED remplaçables
	loadable in kg belastbar in kg chargeable en kg

	packaging / delivery unit Verpackungs- / Liefereinheit unité d'emballage / de livraison
	shortable kürzbar réductible
	Voltage Volt Voltage
	WATT Watt
	USB connection USB-Anschluss Connexion USB
	Qi-Charger

### PROTECTION CLASS / SCHUTZKLASSE / CLASSE DE PROTECTION

The protection class indicates to what extent the lamp is protected against electric shock. All lamps in this catalogue are at least protected with the protection class 1 - a higher class is specified in the information box of the respective lamp.

Die Schutzklasse gibt an, inwiefern ein Produkt gegen einen elektrischen Schlag gesichert ist. Alle Leuchten in diesem Katalog sind mit mindestens Schutzklasse 1 gesichert, bei höheren Klassen wird das Symbol im Infokasten der Leuchte angegeben.

La classe de protection indique, dans quelle mesure la lampe est protégée contre les chocs électriques. Tous les lampes dans ce catalogue sont protégées au moins avec la classe 1 - une classe plus élevée est indiquée dans l'information de la lampe.

	protection class 1: protective earthing Schutzklasse 1: Schutzerdung classe de protection 1: prise de terre
--	---

	protection class 2: protective insulation Schutzklasse 2: Schutzisolierung classe de protection 2: double isolation ou renforcée
--	--

	protection class 3: protective low voltage Schutzklasse 3: Schutzkleinspannung classe de protection 3: très basse tension de sécurité
--	---

### PROTECTION RATING / SCHUTZGRAD / INDICE DE PROTECTION

The protection rating ensures the operational safety of luminaires. The first number specifies the extent of the protection against the ingress of foreign bodies; the second number identifies the humidity protection grade. All luminaires in this catalogue are at least protected with the rating IP20 - a higher rating is specified in the information box of the luminaire.

Der Schutzgrad gewährleistet die Betriebssicherheit von Leuchten. Die erste Ziffer des IP Grades beschreibt den Schutzzumfang gegen das Eindringen von Fremdkörpern; die zweite Ziffer informiert über den Grad des Feuchtigkeitsschutzes. Alle Leuchten in diesem Katalog sind mit mindestens Schutzgrad IP20 gesichert, bei höheren Graden wird das Symbol im Infokasten der Leuchte angegeben.

L'indice de protection assure la sécurité opérationnelle des luminaires. Le premier chiffre indique à quel point la protection est efficace contre l'insertion de corps étrangers; le second chiffre indique quant à lui le degré de protection par rapport à l'humidité. Tous les luminaires dans ce catalogue sont protégés au moins avec l'indice IP20 - un indice plus élevé est indiqué dans l'information d'article.

	IP33		IP44
--	------	--	------

	IP54		IP65
--	------	--	------

	IP67
--	------

# REGISTER

SERIES NAMES

SERIENNAMEN

NOME DE PRODUITS

NAME NAME NOM	PAGE SEITE PAGE	NAME NAME NOM	PAGE SEITE PAGE	NAME NAME NOM	PAGE SEITE PAGE
ABREOSA	248	ARENAZA	831	BELSIANA	502-503
ACOLLA	523	ARISCANI	362-363	BELSIANA 1	503
AGLIENTINA	203	ARRECIFE	703	BENARIBA	547
AGUILARES	353	BAJAZZARA	212-213	BERREGAS	694
ALAMILO	593	BANDERALO	832	BILBANA	815
ALBANY	469	BANKER	856	BIMEDA	738-741
ALBARACCIN	372-373	BARBANO-Z	28-29	BITACHITO	405
ALBARIZA	196	BARBOTTO	270-273	BOCADELLA	400
ALCUDIA	656	BARI 1	673	BOCADELLA 1	500
ALEANDRO 1	380	BARI-M	630	BOLIVIA	436
ALESSANDRA	469	BARNHAM	734-735	BOLSANO	382
ALMEIDA	205	BARRANCAS	506	BORDONARA	498
ALMEIDA 1	204	BASIC	858-859	BORGILLO	799, 854-855
ALMEIDA 2	200-201	BASIC 1	858	BOYAL	240-243
ALMERA	583	BASILANO	342-343	BRENDA	464-466
ALMONTE	624	BASILANO 1	340-341	BROLINI	839
ALMUDAINA	250-251	BASURTU	518	BUCAMARANGA	178
ALOBRASE	355, 358-361	BATABANO	815	BUDENSEA	796
ALTAFLOR	484-486	BATALLAS	686-687	BUENAVISTA	674
ALVEZ	471	BATISTA	355	BUENAVISTA 1	676
AMANDOLO	480-481	BATISTA 3	381, 813	BUENAVISTA 2	676-677
AMEZAGA	816	BATTISTONA	546	BUTRANO	419
AMEZOLA	620	BAYA	804	BUZZ-LED	756-761
AMONTILLADO	414	BAYA LED	802-803	CABADO	776
ANCHORENA-Z	24-25	BAYMAN	299	CABADO 1	851
ANDABAIA-Z	43	BELESER	367, 795	CABALES	848-849
ANDREAS-Z	23	BELLARIVA	810	CABO	522
ARANZOLA	793	BELLARIVA 3	809	CABO 1	764



NAME NAME NOM	PAGE SEITE PAGE	NAME NAME NOM	PAGE SEITE PAGE	NAME NAME NOM	PAGE SEITE PAGE
CABUS	663	CARPENTO	344	CORREDERA	418
CADAQUES	361	CARTAMA	391	CORTADERAS	406,792
CADAQUES 1	361	CARTIGNANO	590	CORTENOVA	394
CADEGAL	608-609	CASIBARE	252-253,698	COSLADA	710
CAGUANES	452	CASTRALVO	454	COSSANO	224-225
CAHUAMA	812	CAUPO	838	COSSANO 2	224-225
CAJERO	850-851	CAYUCA	743	COSWARTH	700
CALAGRANO	564-565	CENCIARA	461,515	COTORRO	689
CALAGRANO-Z	50-51	CEPPINO	844-845	CREMELLA	254-255
CALMANERA	432-433	CERASELLA	375	CUMIOLE	404
CALNOVA	657	CHIETINO 1	809	CURASAO	430
CAMACHO	238-239	CIGLIE	589	DAKAR 1	728-729
CAMASCA	437	CIUDEDELA	423,817	DAKAR 3	778
CAMASTRA	441	CIVITATE	591	DAMASCO 1	821-822
CAMBAITO	436	CLAVELLINA	308-309	DAMBERA	846
CAMBULOS	414	CLEMENTE	383,523	DAVIDA	746-747
CAMINALES-Z	94	CODRIALES	316-317	DAVIDA 1	748-749
CAMPANIA	584	COGNOLI	840	DESIERTO	825
CAMPILO	446	COLTI	584	DUAIA	516
CANICOSA 2	530	COMINIO	357	DUNDRY	872-873
CANTERRAS	246-247	COMPETA 1	548-549	DURELO	569
CAPALBIO	811	CONCESSA 1	194-195	DURENGO	846
CAPASSO	550	CONDRADA 1	522	ELEKTR.TRAFO	882
CAPRAROLA	356,817	CONESA	790	ELIZONDO	604
CARANACOA	312-313	CONESSA	388-389	ELLA	568
CARBONERAS	796	CONNECT Z	21	ENCINITOS	431,505
CARDILLIO 1	766-767,769	CONNECT-Z SENSOR	21	ENEA	730-731
CARDILLIO 2	768-769	CONNECT-Z SWITCH	21	ERMUA	415,815
CARDITO 1	384-385	CONSACA	696	ERSEKA	274-275
CARLTON 2	807	CONTRISA	456	ERVIDEL	306-307
CAROSSO-Z	96-97	CORATO	733	ESCANDELL	266-267
CAROVIGNO	704	CORETTO	377	ESCANDIDOS	262-263

NAME NAME NOM	PAGE SEITE PAGE	NAME NAME NOM	PAGE SEITE PAGE	NAME NAME NOM	PAGE SEITE PAGE
ESPARTAL	791	GENOVESE-Z	53	LANCIANO-Z	90
ESTEPERRA	166, 169, 690	GEO	823	LAROA	842-843
ESTEVAU	422	GERBERA 1	584	LASANA	328
EXTENTION	881	GEXO	848	LASANA 1	324, 329
FABIO	776-777	GIANELLA	318-319	LASANA 2	324-325
FALICETTO	604	GINESTRONE-Z	33	LASANA 3	326-327
FARSALA	365	GIRON	532	LAURITO	556
FATTORIA	218-219	GIRON-S	533	LAZOLO	466
FELONICHE	597	GIRONA	713	LEBALIO	353
FENIGLIA	198-199	GITA 2	660	LED CARPI	636-637
FERENTINO	544-545	GOROSIBA	286-287	LED PALERMO	634-635
FILAGO	452, 521	GOROSIBA 1	286	LED STRIPE-Z	98-99
FIRMO	857	GRADOLI	402	LEJIAS	322-323
FLORESTA	426	GRADOLI 1	403	LIBERTAD	234, 236
FONDACHELLI	788	GRAFIK	581	LIBERTAD 1	235
FORCADET	519	GUANAL	606	LISCIANA	417
FOX	860	GURARE	593	LM_LED_E14	101
FRADELO	526-527	HAYES	605	LM_LED_E27	100-111
FRADELO 1	524-525	HERRORA-Z	74	LM_LED_GU10	101
FRAIOLI-Z	40-41	HORNWOOD-Z	26	LOBATIA	409
FRANIA	534-535, 538-539, 631-632	IMPERIAL	582	LOBINERO-Z	42
FRANIA-A	123	INIESTA	834	LOCANDA	739
FRANIA-S	536-537, 540-541, 631, 633	IPOLITTO	490	LOMALTAS-Z	45
FUEVA 5	638-644, 646	ISIDRO	310-311	LONCINO 1	379
FUEVA-A	128	JUNIOR 1	866	LORD 2	468
FUEVA-Z	76-87	KOB LED	875	LORETO	518-519
GAETANO 1	458-459, 462	KOKOMO-Z	26	LORETO 1	519
GAFARES	488-489	LA SECA	837	LOSALOMAS	435
GASCUERIA	604	LACEY-QI	833	LUBERIO	386
GATUELA 1	412-413	LAGUNITAS	374	LUPPINERIA	560-562
GAZZOLA	439	LANCIANO	542	LURONE	264-265
GEMILIANA	654-655	LANCIANO 1	542-543	MACCACARI	596

NAME NAME NOM	PAGE SEITE PAGE	NAME NAME NOM	PAGE SEITE PAGE	NAME NAME NOM	PAGE SEITE PAGE
MACCHIONE	509	MENTALURGIA	567	NARICES	268-269,407
MADONNINA	818	MESSINARO	502	NARICES 1	268
MAGITTA 1	580	MESTRE	582-583	NASTASIA	202
MAGNUM LED	763	METRASS	610	NEMO	581
MAGNUM-LED	762-763	METRASS 1	613	NEVADO	333
MANALBA	808	METRASS 2	611	NIEVES	553
MANALBA 1	808	MEZZANA	400	NIEVES 1	552
MANILVA 1	632	MINI 4	778-779	NOCITO	736-737
MANIZALES	403	MINIERE	457	NUVANO	461
MANNERA	786-787	MIOGLIA 1	388	OBREGON	447
MANTUNALLE	368	MIRLAS	494	OILELLA	350-351
MANTUNALLE 1	367	MOGANO	512-513	OKINZURI	422
MANZANARES	276-277	MOGANO 1	462	ONEDA	792
MARSALES	172,174	MOGANO 2	514	ONO 2	595
MARBELLA	304-305	MOGANO 3	505	OPTICA	282-284
MARGHERA-Z	36-37	MOHARRAS	515	PADROGIANO-Z	58-60
MARGITTA 1	575	MONIROTE	485,487	PADULARI	482
MARIEL	457,520	MONTEBALDO	405,506	PALAGIANO	565
MARINELLO	493	MONTEFINO	392	PALAGIANO 1	566
MARINELLO 1	492	MONTEFIO	466	PALERMO 2	549
MARMORATA	499	MONTEFIO 1	386-387	PALMERA	672
MAROJALES	520	MONTEMORELOS-Z	52-53	PALMITAL	628-629
MARONDA	205	MONTENOVO	531	PALOMARO	142-143
MARS	577-578	MORDAZO	507	PALOMARO 1	143
MARS 1	576-577	MOSIANO	630	PALOMBAIA	216
MARYVILLA	354,817	MULEGES	428	PALOZZA	335
MASERLO	180-181, 184-186, 188-193	MURCIA	300-301	PALOZZA 1	334
MASERLO 1	182-183	MURMILLO	364	PANAGRIA	244-245
MASERLO 2	180, 186, 189, 192	MURNIA	814	PANDELLA 1	666-669
MASETA	424-425	MUSURITA	554-555	PANDELLA 2	666,670
MASSERIE	830	NADINA	791	PARANDAY-Z	46-47
MATTANZA	220	NARANJO	825	PARRAPOS-Z	48-49

NAME NAME NOM	PAGE SEITE PAGE	NAME NAME NOM	PAGE SEITE PAGE	NAME NAME NOM	PAGE SEITE PAGE
PASCAL 1	583	REMIDOS	609	SALOME	578-579
PASSA	600-603	RENDE	551	SALTO	770-771
PASTERI	138-141, 146-153, 155-161, 806	RICCIO 1	777	SALVILANAS-Z	34-35
PASTORE	144	RIVATO	298	SAMBATELLO	706-707, 709
PASTORE 1	144	ROCAMAR	376, 378	SAN PERI	586
PASTORE 2	145	ROCAMAR 1	377-378	SAN PERI 1	621
PEGUERA	653	ROCCAFORTE	442-445	SANIA 4	598-599
PENJAMO	563	ROLIMARE	483	SANIA 5	650-651
PENJAMO 1	562	ROMAGNESE	380	SARGINTO	614-615
PESCAITO	554	ROMAO	136-137	SARONA	408, 816
PETTO 1	814	ROMAO 1	136	SARRIA	750-753
PICACHA	799	ROMAO 3	136-137	SARSINA-A	124
PICCOLA	785	ROMAO-Z	30	SARSINA-Z	68-69
PIEDRITAS	510	ROMAZZINA	256-259	SAVATARILA-Z	62-63
PINETINA	407	ROMENDO 1	648-649	SAVOY	302-303
PINETTO	634-635	RONCADE	331, 334	SCALEA 1	580
PINTO	294-295	RONCADE 1	330	SEGEZIA	440
PINTO GOLD	292-293	RONDO	278-280	SEGOVIA	214-215
PINTO NERO	290	RONDO 3	280, 407	SELLANO	836
PINTO TEXTIL	289	RONDO 4	794	SELUCI	556-557
PINTO TEXTIL 1	288	ROTTELO	754-755	SELVINA	331-332, 335
PLANET	570	ROVIRA	413	SELVINA 1	330
PLANET 1	570-573	ROVITO-Z	54-57	SELVINO	370-371
PODERE	438	RUEDA	882	SENDERO	226-227
POLLICA	692	RUOTALE	417, 482	SERAS	722-723, 726-727
PORTICO-Z	27	RUSTICARIA	217	SERAS 1	720-721
POZONDON	531	SABINAR	448-449, 451	SERAS 2	724-725
POZUETA	399	SALICETO-Z	95	SIBERIA	320-321
POZUETA 1	397	SALITERAS-Z	63	SIDERNO	650
RAMON	441	SALITRE	418	SILENTINA	508-509
RAZONI	420-421	SALOBRENA-A	126-127	SILERAS	541
RAZONI 1	420-421	SALOBRENA-Z	70-73	SILERAS-Z	91

NAME NAME NOM	PAGE SEITE PAGE	NAME NAME NOM	PAGE SEITE PAGE	NAME NAME NOM	PAGE SEITE PAGE
SILVARES	410	TIMPAROSSA	592	VENEZUELA	260-261
SIMOLARIS-Z	38-39	TINDORI	222-223	VERADAL	844
SLIM	821	TIRRENARA	492	VERADAL-QI	833
SNAPORA	846	TOLLOS-Z	31	VERDELLO	653-654
SOLO	821	TOLORICO	626	VERGIANO	745
SOLO 1	820	TORONA 1	852	VETRO	470-471
SOLO 2	819	TORRETTA	657	VIGLIONI	453
SOREGO	744	TOTARI-Z	88-89	VIKI 1	867
SORRENTA 1	529	TOWNSHEND 3	682-685	VILANOVA	764-765
SPADAFORA	414	TRAGACETE 1	658-659	VINCHIO	670
STAITI	507	TREMEDAL	501	VINOVO	300
STAITI 1	586	TRONDIO	809	VISERBELLA	162-164
STELLATO 1	220-221	TROY 3	296-297	WASAO 1	632
STELLATO 2	221	TRUNCA	830	YUKU-Z	27
STELLATO 3	221	TUDONS	595	ZAMPOTE	490
STICKER	673	TURCONA-Z	64,66-67	ZAPATA	719
SWARBY	813	TURIALDO	232	ZAPATA 1	716
TABARA	867	TURIALDO 1	813	ZARAGOZA	176-177
TABIANO	663	ULISANO	482	ZERACO	753
TABIANO-Z	44	UP 2	800-801	ZILLERIO-Z	42
TABILLANO	714	VADUMI	664	ZINACUA	593
TABILLANO 1	852	VALBIANO	691	ZOCABON	426
TAMARA 1	622-623	VALCASOTTO	559	ZOLA	672
TAMURIA	496	VALCASOTTO 1	517	ZUBIALDE	594
TANURA	606	VALDIOLA	434	ZUBIETA-A	120-122
TARANDELL	329	VALLASPRA	381		
TAREGA	411	VALLEMARE	529		
TARRAFO	453,517	VALLEROSA	314-315		
TAZZOLI	589	VALMORA	332-333		
TELIMBELA-Z	92-93	VARILLAS	171		
TERRAROSA	429	VARRAZO	385		
TEYA	874	VELASCO	210-211		

# REGISTER

ARTICLE NUMBER

ARTIKELNUMMER

NUMÉROS D'ARTICLE

NUMBER NUMMER NUMÉRO	PAGE SEITE PAGE	NUMBER NUMMER NUMÉRO	PAGE SEITE PAGE	NUMBER NUMMER NUMÉRO	PAGE SEITE PAGE	NUMBER NUMMER NUMÉRO	PAGE SEITE PAGE	NUMBER NUMMER NUMÉRO	PAGE SEITE PAGE	NUMBER NUMMER NUMÉRO	PAGE SEITE PAGE
3041	470	12245	109	31577	151	31997	334	39092	342	82844	801
3355	469	12251	101	31578	155	32048	328	39093	343	82942	570
7184	578	12252	101	31581	146	32051	566	39094	343	83119	581
7186	578	12253	100	31582	150	32052	566	39095	342	83132	581
7188	579	12254	101	31588	157	32053	566	39099	340	83153	570
9228	858	12255	110	31589	146	32428	758	39101	340	83154	571
9229	858	12256	110	31592	150	32429	758	39102	341	83155	570
9230	859	12257	110	31594	159	32431	758	39103	340	83156	571
9232	859	12258	111	31595	149	32432	759	39113	344	83157	572
12221	106	30658	608	31596	153	32433	759	39114	344	83159	572
12222	106	30659	608	31599	185	32765	716	43637	513	83162	572
12223	106	30832	748	31601	180	32766	716	80263	577	83163	573
12224	107	30833	749	31602	189	32767	716	80264	577	83404	568
12225	107	30834	749	31603	191	33168	683	80265	578	83406	672
12226	102	30835	749	31605	185	33169	682	81262	776	84028	581
12227	102	30931	522	31606	180	33171	682	81265	777	85104	820
12228	102	31001	738	31607	189	33172	682	81635	568	85261	278
12229	103	31002	738	31608	192	33184	760	81636	568	85262	278
12231	103	31003	739	31611	184	33185	760	81827	823	85263	279
12232	103	31004	738	31613	188	33186	760	81828	823	85264	279
12233	104	31005	740	31614	191	33187	761	82305	821	85832	673
12234	104	31006	741	31616	184	33344	444	82741	582	85856	304
12235	104	31007	741	31618	188	33345	442	82747	303	85857	304
12236	105	31008	741	31627	186	33677	623	82748	302	85858	305
12237	105	31571	156	31629	190	33678	623	82749	302	85859	304
12239	105	31572	146	31631	192	33682	636	82751	303	85971	804
12241	108	31573	151	31666	465	33941	608	82752	303	85974	804
12242	108	31574	155	31667	385	33942	609	82785	471	85977	296
12243	108	31575	157	31995	331	33964	609	82842	800	85978	296
12244	109	31576	147	31996	331	33984	286	82843	800	85979	296

NUMBER NUMMER NUMÉRO	PAGE SEITE PAGE	NUMBER NUMMER NUMÉRO	PAGE SEITE PAGE	NUMBER NUMMER NUMÉRO	PAGE SEITE PAGE	NUMBER NUMMER NUMÉRO	PAGE SEITE PAGE	NUMBER NUMMER NUMÉRO	PAGE SEITE PAGE	NUMBER NUMMER NUMÉRO	PAGE SEITE PAGE
85981	297	89832	294	91433	300	92743	298	93836	377	94605	462
85982	297	89833	295	91496	466	92761	382	93874	803	94606	462
86712	582	89834	294	91589	279	92762	382	93875	802	94609	764
86715	583	89835	294	91971	299	92872	860	93876	802	94612	663
86811	283	89836	295	92084	746	92873	860	93877	802	94613	663
86812	283	90043	580	92085	746	92924	778	93901	836	94617	657
86813	284	90304	290	92086	746	92925	778	93917	800	94626	630
86814	284	90305	290	92087	747	92933	779	93952	143	94635	224
86815	284	90697	584	92143	584	92935	778	93965	838	94636	224
86817	282	90737	584	92146	867	93003	295	93966	838	94673	846
87008	468	90872	857	92147	867	93046	809	94244	391	94677	846
87009	468	90873	857	92206	791	93073	386	94245	391	94697	855
87054	466	90874	857	92251	421	93076	848	94252	739	94698	799
87055	465	90914	754	92252	420	93077	848	94319	380	94699	854
87219	672	90915	754	92288	881	93078	846	94329	777	94702	854
87222	672	90916	754	92348	882	93085	764	94377	379	94704	855
87254	820	90917	755	92563	299	93358	765	94378	379	94705	799
87256	820	90927	755	92595	756	93359	764	94388	421	94712	660
87284	866	90967	856	92596	756	93373	446	94389	420	94713	660
87793	583	90977	858	92597	756	93374	446	94513	814	94714	660
88472	728	90978	469	92598	757	93397	142	94547	512	94716	657
88473	728	90982	731	92599	757	93468	466	94548	512	94764	225
88474	729	90984	730	92641	762	93625	384	94584	735	94765	225
88475	729	90985	730	92642	762	93626	384	94585	734	94878	624
88968	881	90986	730	92643	762	93679	753	94586	734	94879	624
88969	881	91002	301	92644	763	93706	875	94587	734	94884	632
89115	583	91004	300	92645	763	93707	875	94589	376	94918	157
89238	577	91006	301	92727	522	93708	387	94591	376	94919	148
89239	576	91238	821	92741	298	93709	386	94592	378	94921	151
89248	576	91242	823	92742	298	93784	387	94593	378	94924	158

NUMBER NUMMER NUMÉRO	PAGE SEITE PAGE	NUMBER NUMMER NUMÉRO	PAGE SEITE PAGE	NUMBER NUMMER NUMÉRO	PAGE SEITE PAGE	NUMBER NUMMER NUMÉRO	PAGE SEITE PAGE	NUMBER NUMMER NUMÉRO	PAGE SEITE PAGE	NUMBER NUMMER NUMÉRO	PAGE SEITE PAGE
94925	148	95257	225	95569	324	95789	807	96117	575	96437	843
94926	152	95261	224	95591	221	95824	763	96178	766	96438	842
94935	459	95282	636	95597	220	95912	389	96179	766	96439	843
94936	459	95283	637	95598	221	95913	388	96181	767	96474	471
94938	462	95284	523	95602	220	95914	389	96182	766	96477	158
94958	751	95285	523	95606	221	95993	622	96183	767	96478	148
94959	751	95286	383	95629	770	95994	622	96193	226	96479	152
94961	751	95287	383	95631	771	95995	622	96194	226	96481	155
94962	750	95364	602	95632	771	96023	550	96195	226	96483	161
94963	752	95368	601	95639	523	96032	548	96199	227	96484	160
94964	752	95371	602	95655	526	96033	548	96201	227	96528	380
94965	753	95373	603	95656	526	96034	548	96211	222	96538	143
94966	752	95377	601	95657	527	96037	610	96214	223	96539	143
94973	569	95379	602	95659	527	96038	610	96229	632	96541	648
94987	673	95383	447	95661	527	96039	613	96257	222	96542	648
94995	205	95385	447	95672	580	96041	613	96258	223	96543	649
94998	635	95386	808	95679	549	96042	611	96261	600	96544	648
94999	635	95482	736	95682	549	96043	611	96264	600	96552	722
95045	160	95483	736	95684	549	96048	595	96305	333	96553	723
95055	190	95484	737	95686	790	96049	595	96306	335	96554	723
95118	158	95485	736	95689	529	96064	668	96308	332	96555	723
95119	153	95522	410	95694	850	96065	668	96326	332	96566	589
95147	328	95523	410	95695	851	96066	668	96327	332	96567	589
95164	159	95525	411	95696	851	96073	471	96329	331	96773	364
95166	153	95526	411	95725	806	96081	874	96331	333	96774	364
95167	149	95539	788	95726	806	96089	575	96332	333	96866	329
95169	186	95541	788	95755	461	96102	324	96343	365	96937	663
95171	190	95545	719	95775	822	96103	325	96344	365	96957	852
95172	193	95546	719	95776	822	96104	324	96345	365	96981	449
95173	181	95547	719	95785	821	96105	325	96434	842	96982	449
95192	205	95567	329	95787	807	96106	325	96435	842	96983	449
95194	205	95568	329	95788	807	96111	575	96436	843	96985	451



NUMBER NUMMER NUMÉRO	PAGE SEITE PAGE	NUMBER NUMMER NUMÉRO	PAGE SEITE PAGE	NUMBER NUMMER NUMÉRO	PAGE SEITE PAGE	NUMBER NUMMER NUMÉRO	PAGE SEITE PAGE	NUMBER NUMMER NUMÉRO	PAGE SEITE PAGE	NUMBER NUMMER NUMÉRO	PAGE SEITE PAGE
96986	451	97542	533	97652	293	97871	534	98112	684	98323	542
97044	837	97543	533	97653	292	97872	534	98113	684	98324	542
97045	837	97571	873	97655	293	97873	534	98114	684	98325	553
97054	626	97572	872	97667	867	97874	538	98134	706	98326	553
97055	626	97573	872	97682	195	97875	538	98135	706	98331	508
97056	626	97574	872	97683	195	97876	538	98136	707	98332	508
97059	670	97577	541	97684	194	97877	536	98137	706	98333	508
97066	422	97578	541	97685	194	97878	536	98201	127	98334	509
97077	776	97583	271	97699	624	97879	536	98203	127	98346	400
97078	851	97584	271	97718	650	97881	540	98205	126	98347	400
97081	664	97587	381	97719	650	97882	540	98206	126	98353	441
97082	664	97589	813	97731	506	97883	541	98207	124	98379	604
97083	664	97604	406	97733	405	97884	631	98208	124	98384	367
97361	335	97605	406	97734	405	97885	632	98209	124	98386	795
97362	335	97611	138	97737	542	97886	586	98212	128	98387	795
97366	392	97612	141	97773	810	97895	507	98236	123	98393	720
97367	392	97613	139	97774	810	97904	507	98237	123	98394	720
97368	392	97614	140	97777	136	97914	840	98247	830	98395	721
97479	144	97615	138	97778	136	97915	840	98263	589	98396	720
97487	529	97616	141	97779	136	97965	628	98277	882	98397	725
97506	745	97617	139	97783	137	97966	629	98279	882	98398	724
97507	745	97618	140	97784	137	98016	402	98292	128	98399	725
97508	745	97619	138	97793	381	98017	402	98293	128	98408	725
97516	809	97621	141	97806	792	98023	531	98294	123	98409	144
97526	532	97641	162	97838	144	98034	502	98297	126	98421	598
97527	532	97642	163	97839	292	98035	503	98309	791	98422	598
97528	532	97643	162	97841	442	98056	394	98311	171	98423	598
97531	630	97644	162	97845	442	98057	394	98313	171	98424	599
97536	691	97645	164	97846	443	98058	394	98314	171	98425	599
97537	691	97646	164	97854	445	98071	441	98317	500	98426	599
97538	691	97647	164	97855	445	98093	830	98318	500	98446	535
97541	533	97651	292	97857	445	98111	685	98319	500	98447	539

NUMBER NUMMER NUMÉRO	PAGE SEITE PAGE	NUMBER NUMMER NUMÉRO	PAGE SEITE PAGE	NUMBER NUMMER NUMÉRO	PAGE SEITE PAGE	NUMBER NUMMER NUMÉRO	PAGE SEITE PAGE	NUMBER NUMMER NUMÉRO	PAGE SEITE PAGE	NUMBER NUMMER NUMÉRO	PAGE SEITE PAGE
98448	537	98614	358	98735	464	98862	494	99076	700	99266	644
98449	540	98615	358	98752	287	98863	494	99077	232	99267	644
98487	531	98616	358	98753	287	98864	816	99078	232	99268	646
98488	531	98617	359	98754	287	98874	306	99079	232	99269	646
98492	414	98621	704	98755	604	98875	306	99086	594	99271	646
98495	414	98622	704	98759	604	98876	306	99087	594	99272	166
98501	670	98623	704	98762	714	98877	307	99093	275	99273	166
98502	670	98624	692	98763	714	98878	307	99094	275	99274	166
98507	501	98625	692	98764	714	98881	503	99095	275	99275	169
98514	520	98626	692	98831	844	98882	503	99096	274	99276	690
98523	372	98628	388	98832	844	98887	822	99097	274	99277	690
98524	372	98629	388	98834	403	98888	610	99098	274	99278	690
98525	373	98647	360	98835	403	98889	334	99099	21	99279	169
98526	372	98648	361	98836	415	98891	122	99106	21	99286	289
98527	530	98649	360	98837	815	98892	122	99113	796	99287	289
98541	596	98651	362	98838	435	98893	122	99122	620	99288	289
98542	596	98652	362	98839	435	98894	120	99123	620	99292	238
98543	596	98653	363	98841	593	98895	120	99124	620	99293	238
98544	597	98654	363	98842	77	98896	120	99202	638	99294	238
98545	597	98661	399	98843	83	98907	667	99203	638	99295	239
98582	361	98662	399	98844	79	98908	666	99204	641	99296	239
98585	361	98663	399	98845	84	98909	400	99205	640	99297	669
98587	204	98677	666	98846	80	99019	852	99206	638	99314	353
98588	204	98685	530	98847	86	99042	182	99207	639	99315	326
98591	454	98689	422	98849	82	99043	182	99208	640	99316	326
98592	454	98694	370	98852	85	99045	182	99209	640	99317	326
98595	377	98695	371	98854	86	99046	183	99211	643	99318	327
98596	378	98696	370	98855	844	99052	694	99212	642	99319	327
98601	555	98697	370	98856	845	99053	694	99213	642	99321	330
98602	555	98698	371	98858	405	99054	694	99214	642	99322	330
98603	554	98699	371	98859	813	99074	700	99249	418	99323	330
98604	555	98734	464	98861	494	99075	700	99265	644	99324	524

NUMBER NUMMER NUMÉRO	PAGE SEITE PAGE	NUMBER NUMMER NUMÉRO	PAGE SEITE PAGE	NUMBER NUMMER NUMÉRO	PAGE SEITE PAGE	NUMBER NUMMER NUMÉRO	PAGE SEITE PAGE	NUMBER NUMMER NUMÉRO	PAGE SEITE PAGE	NUMBER NUMMER NUMÉRO	PAGE SEITE PAGE
99325	524	99447	196	99541	189	99606	614	99661	430	99698	419
99327	525	99457	241	99542	192	99607	614	99662	430	99699	553
99328	524	99463	413	99543	180	99608	615	99663	461	99701	453
99329	808	99464	412	99544	246	99609	614	99664	505	99702	453
99331	808	99466	243	99545	246	99611	201	99665	431	99703	563
99332	809	99467	242	99546	247	99612	200	99666	431	99704	563
99334	848	99468	242	99547	247	99613	172	99667	518	99705	426
99335	849	99469	243	99548	74	99614	350	99669	95	99706	426
99339	659	99486	200	99549	74	99615	350	99671	95	99707	426
99343	547	99487	200	99551	252	99616	350	99672	95	99711	696
99344	547	99488	686	99552	252	99617	351	99673	94	99712	696
99345	254	99489	686	99553	252	99618	428	99674	94	99713	696
99346	254	99491	686	99554	253	99619	428	99675	94	99715	799
99347	255	99492	687	99555	253	99621	559	99676	45	99731	666
99348	586	99506	255	99559	334	99622	559	99677	45	99772	674
99353	241	99507	255	99561	311	99623	559	99678	34	99773	674
99358	316	99508	145	99562	310	99624	240	99679	34	99774	674
99366	368	99509	145	99563	311	99625	242	99681	34	99776	658
99367	368	99511	248	99564	311	99628	375	99682	35	99777	658
99368	368	99512	248	99591	269	99629	375	99683	35	99778	658
99371	367	99513	248	99592	269	99631	286	99684	98	99779	556
99395	483	99517	698	99593	268	99632	286	99685	98	99781	557
99397	567	99518	698	99594	269	99633	425	99686	99	99782	556
99398	567	99519	698	99595	590	99634	424	99687	99	99783	556
99406	554	99523	174	99596	591	99635	424	99689	593	99784	486
99407	554	99524	172	99597	825	99636	424	99691	651	99785	486
99408	240	99525	172	99599	414	99639	74	99692	650	99786	486
99413	240	99526	174	99601	38	99651	374	99693	432	99787	485
99438	440	99527	174	99602	38	99654	374	99694	432	99788	484
99439	440	99531	409	99603	38	99655	496	99695	433	99789	485
99445	196	99532	409	99604	39	99656	496	99696	433	99791	487
99446	196	99539	186	99605	39	99659	493	99697	419	99792	485

NUMBER NUMMER NUMÉRO	PAGE SEITE PAGE	NUMBER NUMMER NUMÉRO	PAGE SEITE PAGE	NUMBER NUMMER NUMÉRO	PAGE SEITE PAGE	NUMBER NUMMER NUMÉRO	PAGE SEITE PAGE	NUMBER NUMMER NUMÉRO	PAGE SEITE PAGE	NUMBER NUMMER NUMÉRO	PAGE SEITE PAGE
99793	492	99855	234	900071	37	900113	78	900169	726	900325	594
99794	825	99856	234	900072	37	900114	84	900171	726	900328	490
99795	234	900001	88	900076	41	900115	84	900172	727	900329	490
99796	236	900002	88	900077	41	900116	21	900173	726	900331	744
99797	236	900005	90	900078	41	900128	91	900174	417	900332	744
99798	236	900006	90	900079	40	900129	91	900175	417	900333	744
99799	322	900019	44	900081	40	900134	793	900176	265	900334	813
99801	322	900021	44	900082	40	900135	793	900177	264	900335	550
99802	322	900022	63	900083	90	900141	819	900178	265	900336	92
99803	323	900023	63	900084	88	900142	819	900179	265	900337	92
99804	323	900024	63	900085	89	900143	436	900185	521	900338	92
99805	323	900025	62	900086	54	900144	176	900186	452	900339	93
99806	262	900044	70	900087	55	900145	176	900187	788	900341	288
99807	262	900045	70	900088	54	900146	176	900188	518	900342	288
99808	263	900046	70	900089	54	900147	177	900195	353	900343	606
99809	262	900047	71	900091	57	900148	177	900196	353	900346	439
99811	403	900048	71	900092	56	900149	550	900302	506	900347	202
99817	490	900049	72	900093	56	900151	210	900304	277	900348	202
99818	418	900051	72	900094	56	900152	210	900305	276	900349	235
99819	413	900052	72	900095	73	900153	210	900306	277	900351	308
99821	413	900053	73	900099	76	900154	211	900307	277	900352	308
99822	796	900054	64	900101	76	900157	519	900313	454	900353	308
99824	812	900055	64	900102	76	900158	437	900314	814	900354	309
99825	812	900056	64	900103	82	900159	437	900315	46	900355	510
99828	831	900057	66	900104	82	900161	448	900316	46	900356	510
99829	831	900058	66	900105	80	900162	448	900317	46	900357	510
99831	832	900059	66	900106	80	900163	448	900318	47	900358	815
99832	832	900061	67	900107	81	900164	254	900319	49	900359	512
99838	676	900062	67	900108	86	900165	260	900321	49	900361	520
99839	676	900067	36	900109	87	900166	260	900322	48	900362	457
99853	676	900068	36	900111	78	900167	260	900323	48	900363	631
99854	677	900069	36	900112	78	900168	261	900324	48	900364	633

NUMBER NUMMER NUMÉRO	PAGE SEITE PAGE	NUMBER NUMMER NUMÉRO	PAGE SEITE PAGE	NUMBER NUMMER NUMÉRO	PAGE SEITE PAGE	NUMBER NUMMER NUMÉRO	PAGE SEITE PAGE	NUMBER NUMMER NUMÉRO	PAGE SEITE PAGE	NUMBER NUMMER NUMÉRO	PAGE SEITE PAGE
900365	635	900409	52	900465	320	900503	212	900561	499	900626	833
900366	634	900411	53	900466	320	900504	213	900562	313	900628	833
900367	502	900412	53	900467	320	900505	213	900563	312	900631	316
900369	636	900419	483	900468	321	900506	355	900564	313	900632	316
900375	605	900421	488	900469	321	900507	355	900565	313	900633	317
900376	203	900422	489	900471	482	900508	355	900566	51	900634	178
900377	203	900423	489	900472	417	900509	509	900567	50	900635	178
900378	203	900424	489	900475	653	900511	280	900571	498	900636	89
900379	456	900425	436	900476	654	900512	280	900572	498	900661	713
900381	456	900426	436	900477	53	900513	768	900573	498	900662	713
900382	709	900428	621	900478	42	900514	769	900596	482	900663	713
900383	709	900429	434	900479	42	900515	769	900597	482	900686	257
900384	709	900431	434	900481	58	900516	768	900598	543	900687	258
900385	217	900432	689	900482	60	900517	606	900599	543	900693	710
900386	217	900433	689	900483	58	900518	606	900601	564	900694	710
900387	24	900434	689	900484	58	900519	257	900602	565	900695	710
900388	24	900435	517	900485	60	900521	259	900603	492	900696	458
900391	24	900436	743	900486	59	900522	257	900604	492	900697	458
900392	25	900437	743	900487	59	900523	259	900605	546	900701	161
900393	792	900438	743	900488	244	900524	507	900606	546	900702	26
900394	792	900439	30	900489	244	900525	592	900607	544	900711	703
900395	280	900441	30	900491	244	900526	592	900608	544	900712	703
900396	815	900442	30	900492	245	900528	839	900609	545	900713	703
900398	42	900443	517	900493	245	900529	839	900611	545	900714	733
900399	404	900444	453	900494	256	900549	354	900612	551	900715	733
900401	408	900446	452	900495	256	900551	354	900613	551	900716	733
900402	408	900457	786	900496	258	900552	817	900614	519	900717	593
900403	816	900458	787	900497	259	900553	514	900615	655	900721	505
900404	43	900459	786	900498	552	900554	514	900616	654	900722	33
900406	31	900461	786	900499	552	900555	514	900617	656	900723	33
900407	31	900463	561	900501	552	900558	499	900618	656	900724	33
900408	52	900464	561	900502	212	900559	499	900619	631	900728	50

NUMBER NUMMER NUMÉRO	PAGE SEITE PAGE	NUMBER NUMMER NUMÉRO	PAGE SEITE PAGE	NUMBER NUMMER NUMÉRO	PAGE SEITE PAGE	NUMBER NUMMER NUMÉRO	PAGE SEITE PAGE
900729	50	900826	521	900865	519	900909	250
900731	266	900828	420	900866	429	900916	315
900732	266	900829	421	900867	429	900917	314
900733	267	900831	216	900868	794	900918	315
900734	267	900832	216	900869	794	900919	315
900735	267	900833	457	900871	595	900923	785
900736	515	900834	457	900872	270	900924	785
900738	215	900835	438	900873	270	900925	785
900739	214	900836	438	900874	273	900926	251
900741	215	900837	516	900875	272	900928	653
900742	215	900838	516	900876	272	900929	653
900758	69	900839	769	900877	273	900945	818
900759	69	900841	27	900878	23	900946	818
900761	69	900842	27	900879	23	900947	319
900762	68	900843	268	900881	27	900948	318
900763	96	900844	629	900882	26	900949	319
900764	97	900845	629	900883	26	900951	318
900765	96	900846	634	900892	241	900952	480
900766	97	900847	220	900893	357	900953	481
900792	505	900848	515	900894	357	900954	481
900795	560	900849	461	900895	385	900955	481
900796	560	900853	28	900896	423	900956	834
900797	562	900854	29	900897	423	900957	834
900798	397	900855	28	900898	817	900958	834
900799	397	900856	29	900901	219	900975	407
900801	397	900857	562	900902	219	900976	407
900812	356	900858	199	900903	219	900977	407
900813	356	900859	199	900904	218	901015	319
900814	817	900861	198	900905	218		
900823	811	900862	199	900906	251		
900824	811	900863	565	900907	250		
900825	521	900864	565	900908	250		



# NOTES

NOTIZEN

NOTES

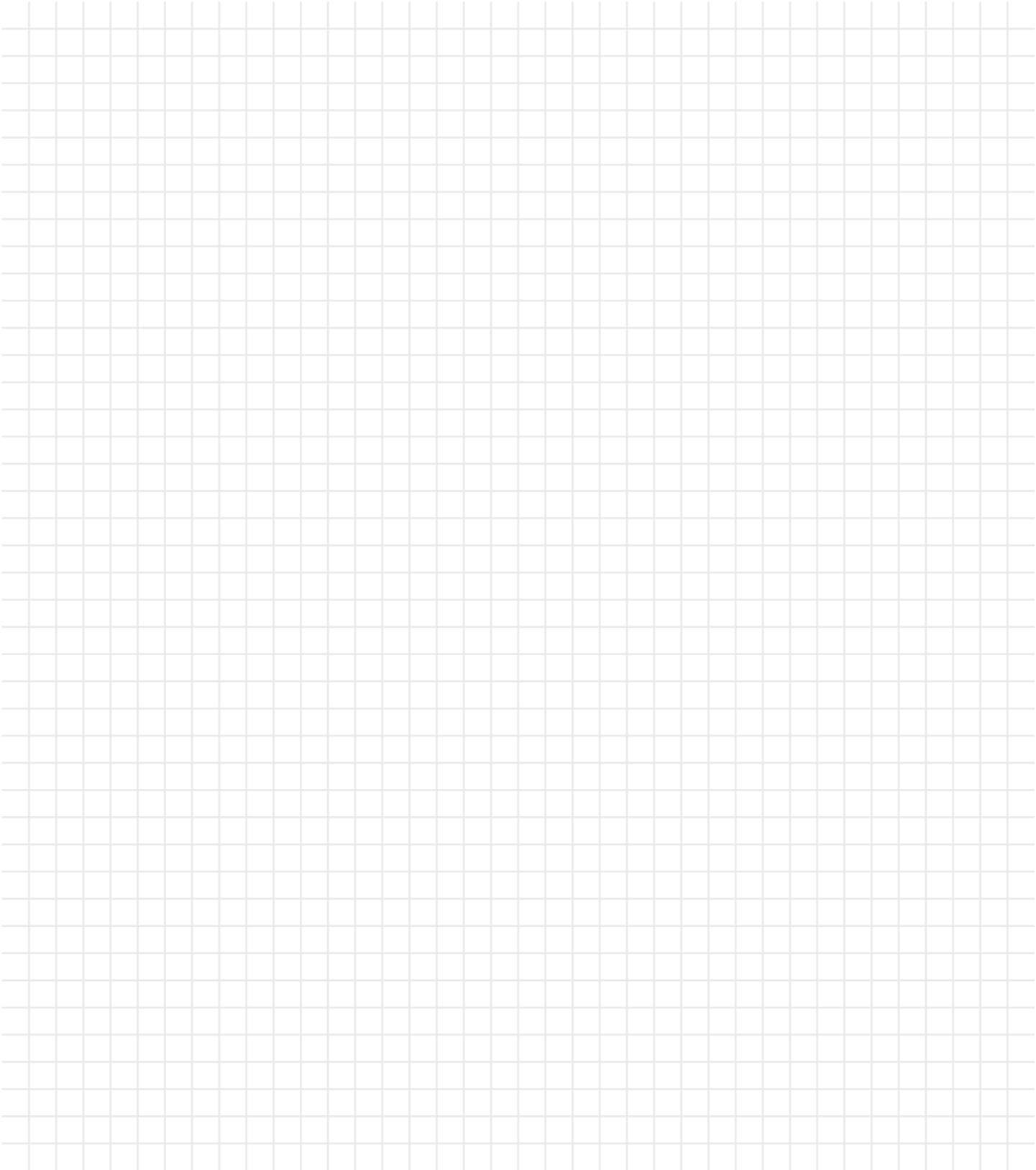



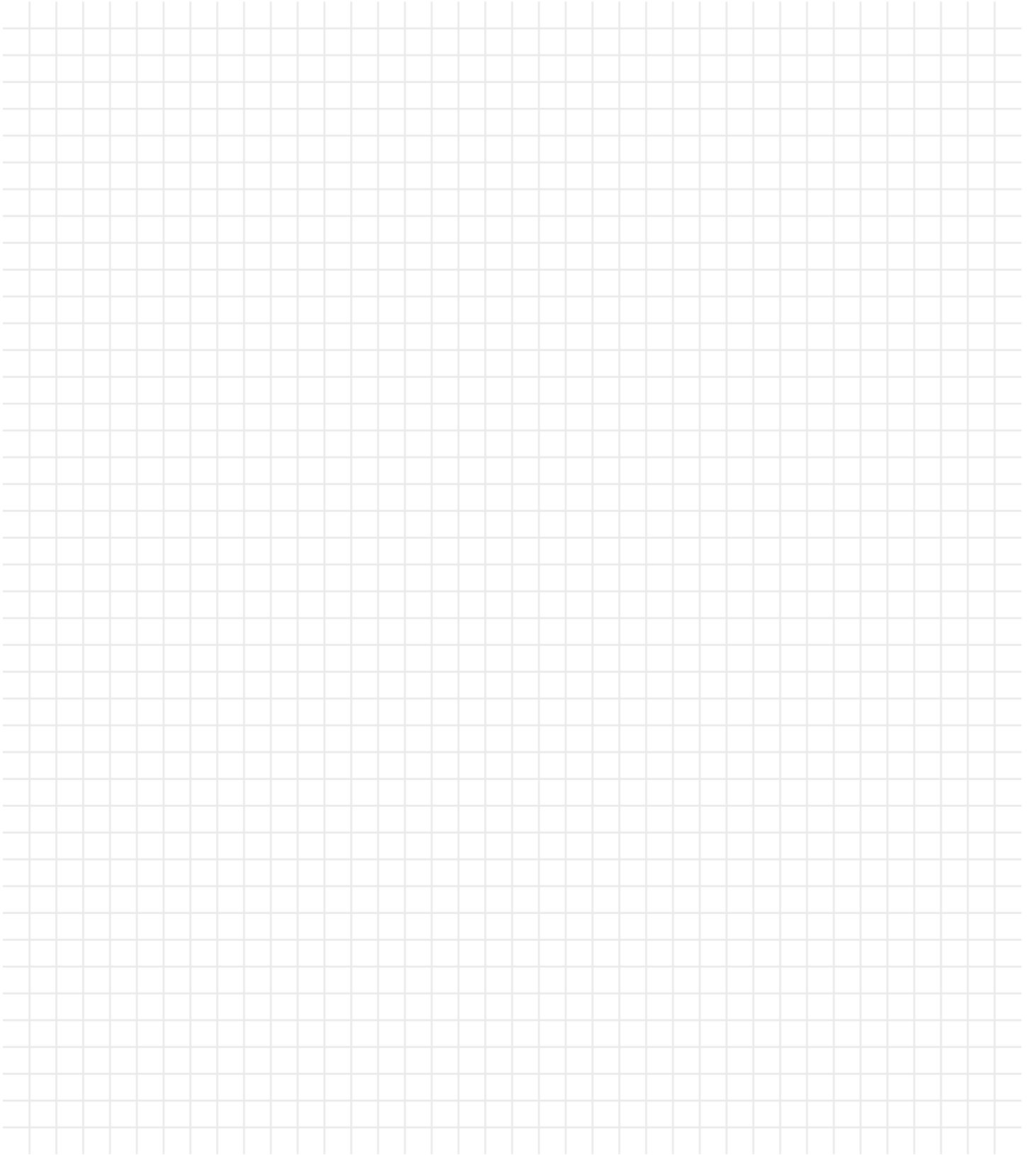

All previous catalogues and price lists are no longer valid with the issue of this catalogue. Errors, misprints, model and price changes and technical modifications are reserved. We deliver based on our terms of delivery and payment. Our products comply with the European light norm EN60598. Products with the ENEC test mark are conforming to the guide line 2006/95/EG. Products with additional safety remarks (e.g protection class, IP) are identified within the product family with the relevant symbol and number. The content of this catalogue is protected under copyright law for EGLO Leuchten GmbH. All rights reserved. Our specific written consent must be obtained before using any illustrations and texts. The pictures are 4C prints and may differ from the original. The product pictures and ambiances in this catalogue can deviate from reality, and they do not necessarily concur with the usual application of the product. EGLO does not assume liability for the correctness, completeness or the application depiction of the products and/or the product information. Design, layout and composition: EGLO GmbH, A-6136 Pill - AUSTRIA Print: Samson Druck GmbH, 5581 St. Margarethen - AUSTRIA Pictures: EGLO, Adobe Stock, istockphoto.com

---

Mit diesem Katalog verlieren alle vorhergehenden Kataloge und Preislisten ihre Gültigkeit. Irrtümer, Druckfehler, Modell- und Preisänderungen sowie technische Änderungen vorbehalten. Wir liefern zu unseren Liefer- und Zahlungsbedingungen. Unsere Produkte entsprechen der europäischen Leuchtnorm EN 60598. Produkte mit dem ENEC Prüfzeichen sind konform mit der Richtlinie 2006/95/EG. Produkte mit weiteren Sicherheitshinweisen (zB. Schutzklasse, IP) sind mit Symbol und Zahl bei der Produktfamilie ausgezeichnet. Der Inhalt dieses Kataloges ist für die EGLO Leuchten GmbH urheberrechtlich geschützt. Alle Rechte sind vorbehalten. Bilder und Texte dürfen nicht ohne vorherige ausdrückliche, schriftliche Genehmigung verwendet werden. Die Abbildungen sind 4C Drucke und können vom Original abweichen. Die Katalogbilder und die gezeigten Darstellungen der Produkte können von der Wirklichkeit abweichen und nicht den üblichen Produktanwendungen entsprechen. EGLO übernimmt keine Haftung für die Richtigkeit, Vollständigkeit und Anwendungsdarstellung der Produkte und Produktinformationen. Gestaltung, Layout und Satz: EGLO GmbH, A-6136 Pill - AUSTRIA Druck: Samson Druck GmbH, 5581 St. Margarethen - AUSTRIA Bilder: EGLO, Adobe Stock, istockphoto.com

---

Le présent catalogue remplace tous les catalogues et tarifs précédents. Sous réserve d'erreurs, de fautes d'impression, de modification des modèles et de changement de prix et de technique. Nous livrons sur la base de nos conditions de livraison et de paiement. Nos produits sont conformes aux normes européennes EN 60598 et portent le marquage CE. Les produits portant la marque ENEC sont conformes à la Directive 2006/95/EG. Les produits portant d'autres indications de sécurité (par exemple classe de protection, IP) sont identifiés par le symbole et le nombre correspondants dans la famille de produits. Le contenu du présent catalogue est protégé pour la société EGLO Leuchten GmbH par un copyright. Tous droits réservés. Toute reproduction d'images et du texte est interdite sans autorisation explicite par écrit préalable. Les images sont imprimées en 4C et peuvent différer de l'original. Les images des produits et les ambiances dans le catalogue peuvent dévier de la réalité et ne sont pas nécessairement en ligne avec l'usage habituel du produit. EGLO n'engage pas sa responsabilité sur la justesse des images et sur les informations relatives à l'usage pouvant être fait des produits. Conception, maquette et composition: EGLO GmbH, A-6136 Pill - AUSTRIA Presse: Samson Druck GmbH, 5581 St. Margarethen - AUSTRIA Images: EGLO, Adobe Stock, istockphoto.com

06-2023





EGLO Leuchten GmbH  
Heiligkreuz 22  
A-6136 Pill  
Austria  
Tel. +43 (0) 5242 6996  
Fax +43 (0) 5242 6996-972  
info@eglo.com  
www.eglo.com

KAT-23

my light | my style